



Chipsmall Limited consists of a professional team with an average of over 10 year of expertise in the distribution of electronic components. Based in Hongkong, we have already established firm and mutual-benefit business relationships with customers from,Europe,America and south Asia,supplying obsolete and hard-to-find components to meet their specific needs.

With the principle of “Quality Parts,Customers Priority,Honest Operation,and Considerate Service”,our business mainly focus on the distribution of electronic components. Line cards we deal with include Microchip,ALPS,ROHM,Xilinx,Pulse,ON,Everlight and Freescale. Main products comprise IC,Modules,Potentiometer,IC Socket,Relay,Connector.Our parts cover such applications as commercial,industrial, and automotives areas.

We are looking forward to setting up business relationship with you and hope to provide you with the best service and solution. Let us make a better world for our industry!



Contact us

Tel: +86-755-8981 8866 Fax: +86-755-8427 6832

Email & Skype: info@chipsmall.com Web: www.chipsmall.com

Address: A1208, Overseas Decoration Building, #122 Zhenhua RD., Futian, Shenzhen, China



TN3019A

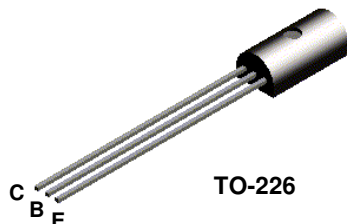

NPN General Purpose Amplifier

This device is designed for general purpose medium power amplifiers and switches requiring collector currents to 500 mA and collector voltages up to 80 V. Sourced from Process 12.

Absolute Maximum Ratings* TA = 25°C unless otherwise noted

Symbol	Parameter	Value	Units
V_{CEO}	Collector-Emitter Voltage	80	V
V_{CBO}	Collector-Base Voltage	140	V
V_{EBO}	Emitter-Base Voltage	7.0	V
I_C	Collector Current - Continuous	1.0	A
T_J, T_{stg}	Operating and Storage Junction Temperature Range	-55 to +150	°C

*These ratings are limiting values above which the serviceability of any semiconductor device may be impaired.

NOTES:

- 1) These ratings are based on a maximum junction temperature of 150 degrees C.
- 2) These are steady state limits. The factory should be consulted on applications involving pulsed or low duty cycle operations.

Thermal Characteristics TA = 25°C unless otherwise noted

Symbol	Characteristic	Max	Units
		TN3019A	
P_D	Total Device Dissipation	1.0	W
	Derate above 25°C	8.0	mW/°C
$R_{\theta JC}$	Thermal Resistance, Junction to Case	125	°C/W
$R_{\theta JA}$	Thermal Resistance, Junction to Ambient	50	°C/W

NPN General Purpose Amplifier

(continued)

TN3019A

Electrical Characteristics

TA = 25°C unless otherwise noted

Symbol	Parameter	Test Conditions	Min	Max	Units
--------	-----------	-----------------	-----	-----	-------

OFF CHARACTERISTICS

$V_{(BR)CEO}$	Collector-Emitter Breakdown Voltage*	$I_C = 30 \text{ mA}, I_B = 0$	80		V
$V_{(BR)CBO}$	Collector-Base Breakdown Voltage	$I_C = 100 \text{ } \mu\text{A}, I_E = 0$	140		V
$V_{(BR)EBO}$	Emitter-Base Breakdown Voltage	$I_E = 100 \text{ } \mu\text{A}, I_C = 0$	7.0		V
I_{CBO}	Collector-Cutoff Current	$V_{CB} = 90 \text{ V}, I_E = 0$ $V_{CB} = 90 \text{ V}, I_E = 0, T_A = 150^\circ\text{C}$		0.01 10	μA μA
I_{EBO}	Emitter-Cutoff Current	$V_{EB} = 5.0 \text{ V}, I_C = 0$		0.01	μA

ON CHARACTERISTICS

h_{FE}	DC Current Gain	$I_C = 0.1 \text{ mA}, V_{CE} = 10 \text{ V}$ $I_C = 10 \text{ mA}, V_{CE} = 10 \text{ V}$ $I_C = 150 \text{ mA}, V_{CE} = 10 \text{ V}$ $I_C = 150 \text{ mA}, V_{CE} = 10 \text{ V}, T_A = -55^\circ\text{C}$ $I_C = 500 \text{ mA}, V_{CE} = 10 \text{ V}^*$ $I_C = 1.0 \text{ A}, V_{CE} = 10 \text{ V}^*$	50 90 100 40 50 15	300	
$V_{CE(sat)}$	Collector-Emitter Saturation Voltage	$I_C = 150 \text{ mA}, I_B = 15 \text{ mA}$ $I_C = 500 \text{ mA}, I_B = 50 \text{ mA}$		0.2 0.5	V V
$V_{BE(sat)}$	Base-Emitter Saturation Voltage	$I_C = 10 \text{ mA}, I_B = 15 \text{ mA}$		1.1	V

SMALL SIGNAL CHARACTERISTICS

f_T	Current Gain - Bandwidth Product	$I_C = 50 \text{ mA}, V_{CE} = 10 \text{ V},$ $f = 20 \text{ MHz}$	100		MHz
C_{obo}	Output Capacitance	$V_{CB} = 10 \text{ V}, I_E = 0, f = 1.0 \text{ MHz}$		12	pF
C_{ibo}	Input Capacitance	$V_{BE} = 0.5 \text{ V}, I_C = 0, f = 1.0 \text{ MHz}$		60	pF
h_{fe}	Small-Signal Current Gain	$I_C = 1.0 \text{ mA}, V_{CE} = 5.0 \text{ V},$ $f = 1.0 \text{ kHz}$	80	400	
$r_b'C_c$	Collector Base Time Constant	$I_E = 10 \text{ mA}, V_{CB} = 10 \text{ V},$ $f = 4.0 \text{ MHz}$		400	pS
NF	Noise Figure	$I_C = 100 \text{ mA}, V_{CE} = 10 \text{ V},$ $R_S = 1.0 \text{ k}\Omega, f = 1.0 \text{ kHz}$		4.0	dB

*Pulse Test: Pulse Width $\leq 300 \text{ } \mu\text{s}$, Duty Cycle $\leq 1.0\%$

Typical Characteristics

Typical Pulsed Current Gain vs Collector Current

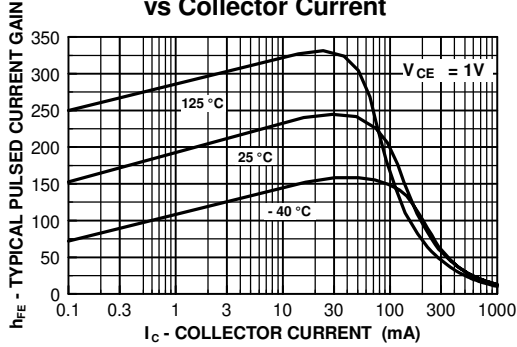

Collector-Emitter Saturation Voltage vs Collector Current

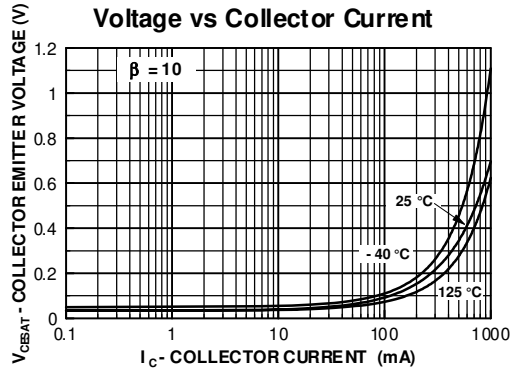

Base-Emitter Saturation Voltage vs Collector Current

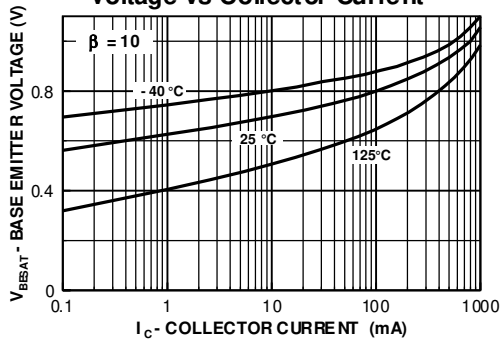

Base Emitter ON Voltage vs Collector Current

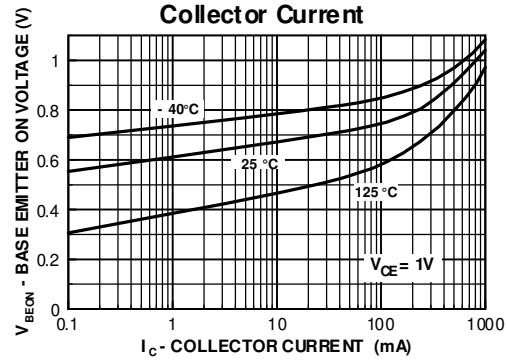

Collector-Cutoff Current vs Ambient Temperature

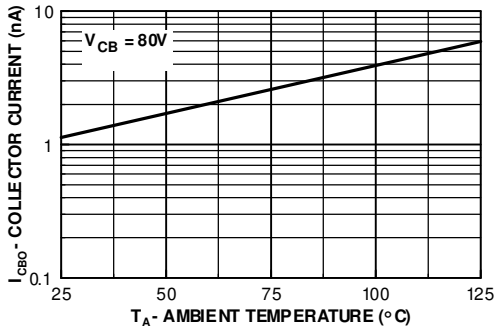

Collector-Base and Emitter-Base Capacitance vs Reverse Bias Voltage

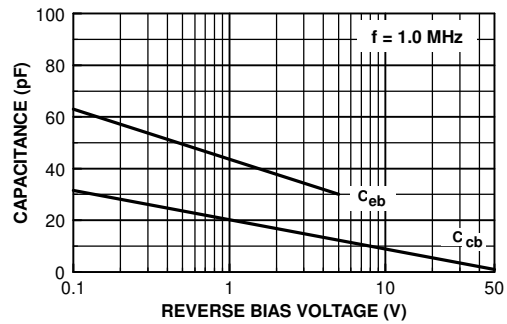

Typical Characteristics (continued)

Small Signal Current Gain at 20 MHz

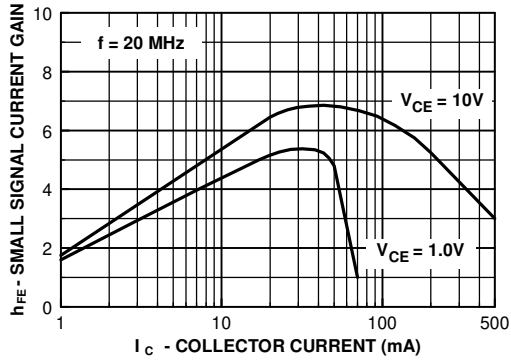

Switching Times vs Collector Current

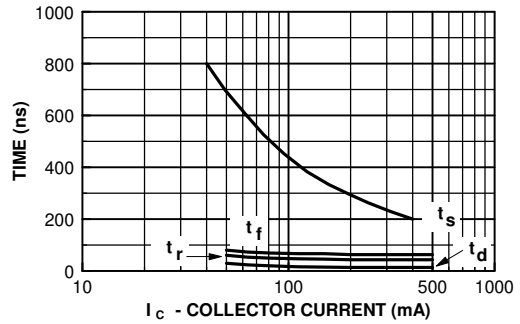

Turn On and Turn Off Times vs Collector Current

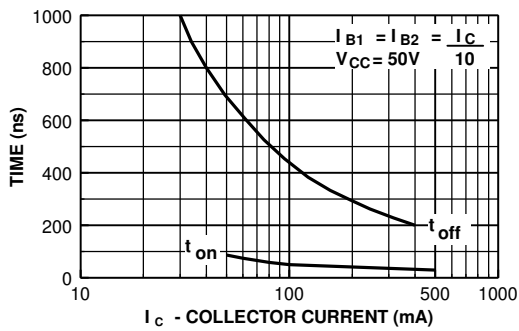

Power Dissipation vs Ambient Temperature

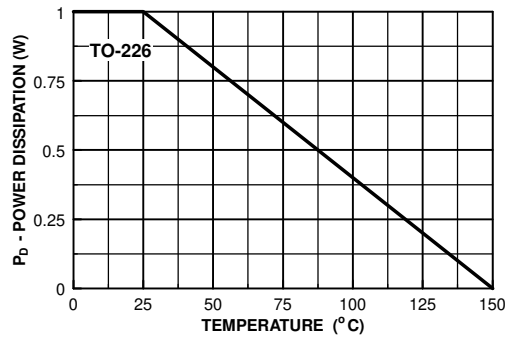

NPN General Purpose Amplifier

(continued)

TN3019A

Test Circuit

I_C	R_b	R_L
150 mA	314 Ω	330 Ω
200 mA	157 Ω	167 Ω
500 mA	94 Ω	100 Ω

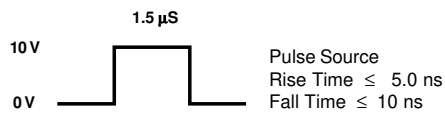
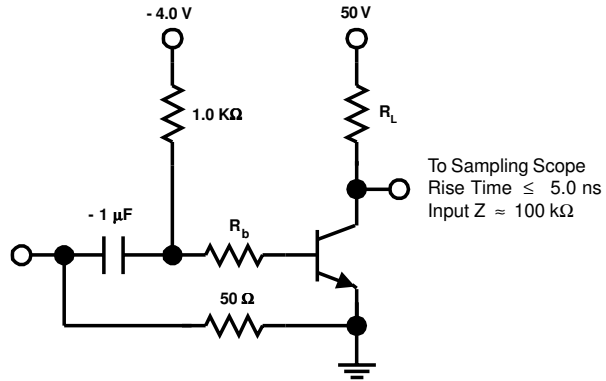

FIGURE 1: t_{ON} , t_{OFF} Test Circuit

TO-226AE Tape and Reel Data



TO-226AE Packaging
Configuration: Figure 1.0

FSCINT Label sample

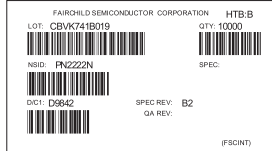

F63TNR Label sample

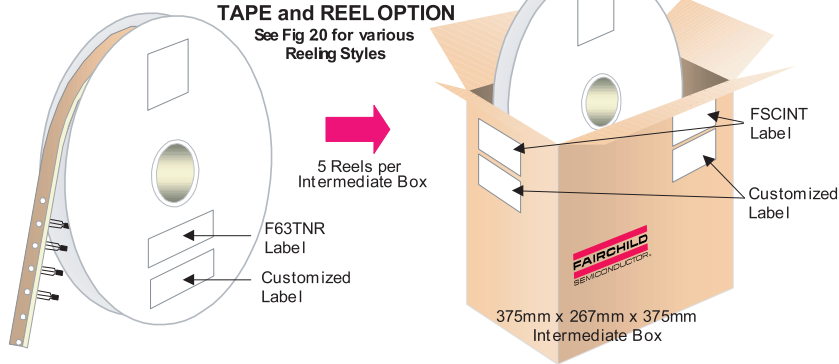

TO-226AE TNR/AMMO PACKING INFORMATION

Packing	Style	Quantity	EOL code
Reel	A	2,000	D26Z
	E	2,000	D27Z
Ammo	M	2,000	D74Z
	P	2,000	D75Z

Unit weight = 0.300gm
Reel weight with components = 0.868 kg
Ammo weight with components = 0.880 kg
Max quantity per intermediate box = 10,000 units

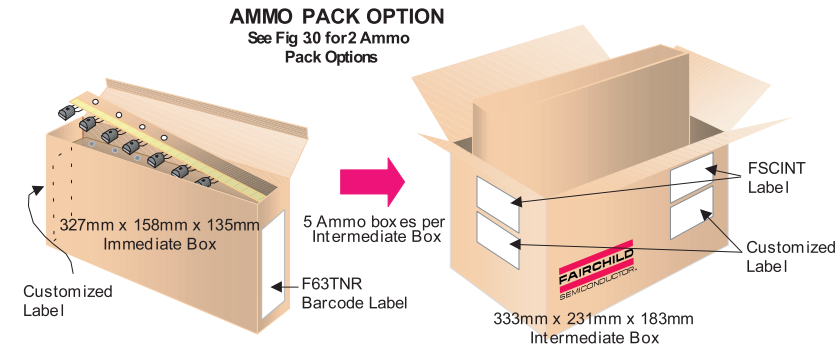

(TO-226AE) BULK PACKING INFORMATION

EOL CODE	DESCRIPTION	LEADCLIP DIMENSION	QUANTITY
J18Z	TO-18 OPTION STD	NO LEAD CLIP	1.0 K / BOX
J05Z	TO-5 OPTION STD	NO LEAD CLIP	1.0 K / BOX
NO EOL CODE	TO-226 STANDARD STRAIGHT	NO LEADCLIP	1.5 K / BOX

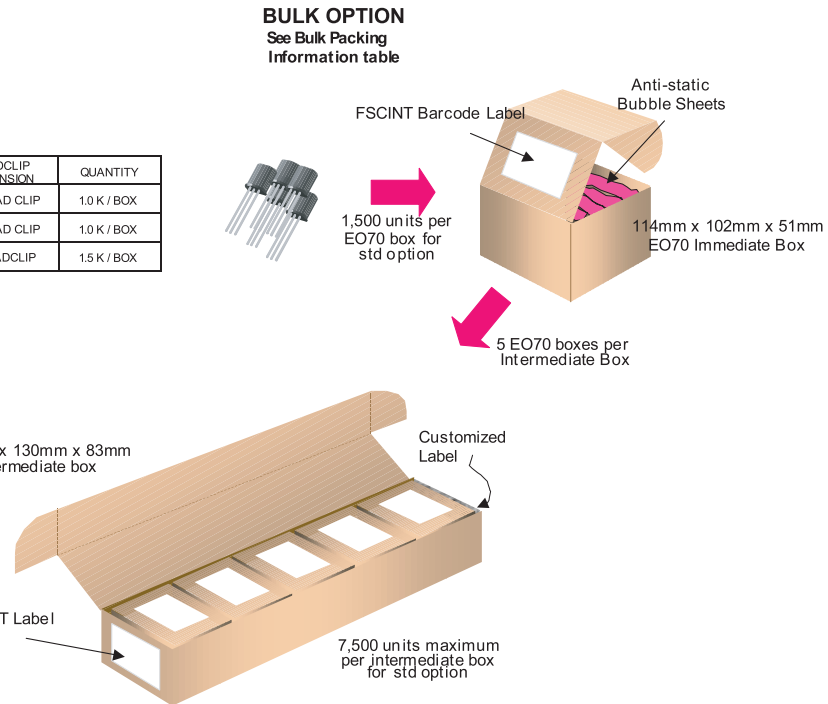

TO-226AE Tape and Reel Data, continued

TO-226AE Reeling Style Configuration: Figure 2.0

Machine Option "A"(H)

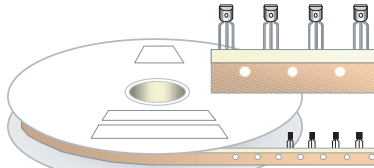

Style "A" D26Z, D70Z (s/h)

Machine Option "E"(J)

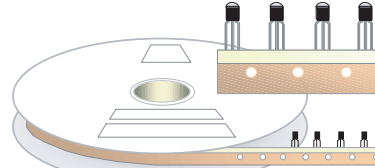

Style "E" D27Z, D71Z (s/h)

TO-226AE Radial Ammo Packaging Configuration: Figure 3.0

FIRST WIRE OFF IS COLLECTOR (ON PKG. 92)
ADHESIVE TAPE IS ON THE TOP SIDE
FLAT OF TRANSISTOR IS ON TOP

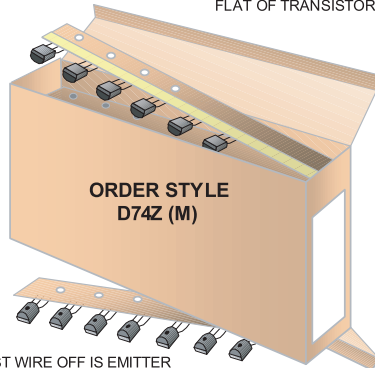

ORDER STYLE
D74Z (M)

FIRST WIRE OFF IS EMITTER
ADHESIVE TAPE IS ON BOTTOM SIDE
FLAT OF TRANSISTOR IS ON BOTTOM

FIRST WIRE OFF IS EMITTER (ON PKG. 92)
ADHESIVE TAPE IS ON THE TOP SIDE
FLAT OF TRANSISTOR IS ON BOTTOM

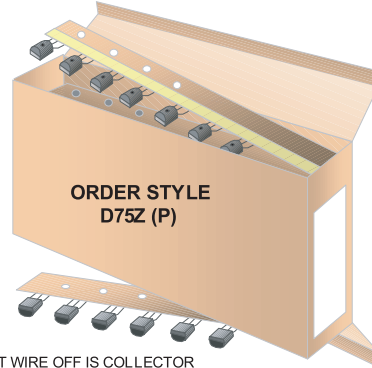

ORDER STYLE
D75Z (P)

FIRST WIRE OFF IS COLLECTOR
ADHESIVE TAPE IS ON BOTTOM SIDE
FLAT OF TRANSISTOR IS ON TOP

TO-226AE Tape and Reel Data, continued

**TO-226AE Tape and Reel Taping
Dimension Configuration:** Figure 4.0

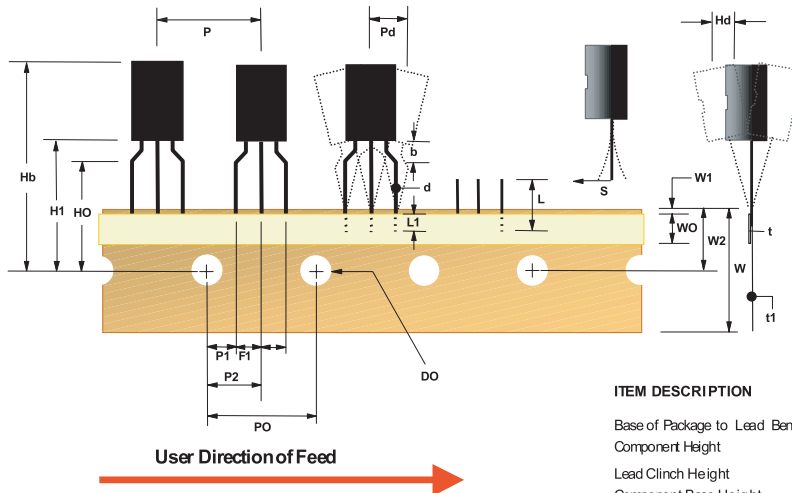

ITEM DESCRIPTION	SYMBOL	DIMENSION
Base of Package to Lead Bend	b	0.098 (max)
Component Height	Hb	1.078 (+/- 0.050)
Lead Clinch Height	HO	0.630 (+/- 0.020)
Component Base Height	H1	0.748 (+/- 0.020)
Component Alignment (side/side)	Pd	0.040 (max)
Component Alignment (front/back)	Hd	0.031 (max)
Component Pitch	P	0.500 (+/- 0.020)
Feed Hole Pitch	PO	0.500 (+/- 0.008)
Hole Center to First Lead	P1	0.150 (+0.009, -0.010)
Hole Center to Component Center	P2	0.247 (+/- 0.007)
Lead Spread	F1/F2	0.104 (+/- 0.010)
Lead Thickness	d	0.018 (+0.002, -0.003)
Out Lead Length	L	0.429 (max)
Taped Lead Length	L1	0.209 (+0.051, -0.052)
Taped Lead Thickness	t	0.032 (+/- 0.006)
Carrier Tape Thickness	t1	0.021 (+/- 0.006)
Carrier Tape Width	W	0.708 (+0.02, -0.019)
Hold - down Tape Width	W0	0.236 (+/- 0.012)
Hold - down Tape position	W1	0.035 (max)
Feed Hole Position	W2	0.360 (+/- 0.025)
Sprocket Hole Diameter	DO	0.157 (+0.008, -0.007)
Lead Spring Out	S	0.004 (max)

Note: All dimensions are in inches.

**TO-226AE Reel
Configuration:** Figure 5.0

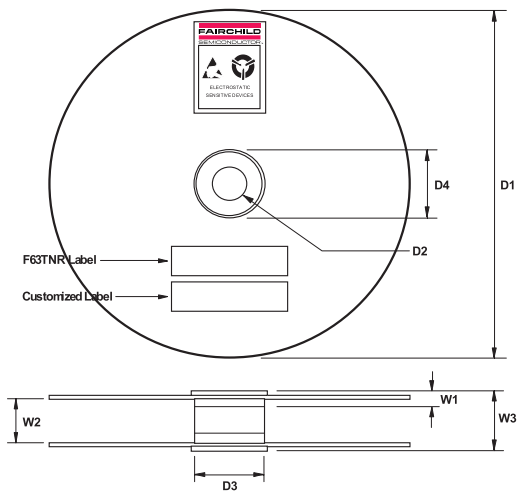

ITEM DESCRIPTION	SYMBOL	MINIMUM	MAXIMUM
Reel Diameter	D1	13.975	14.025
Arbor Hole Diameter (Standard)	D2	1.160	1.200
(Small Hole)	D2	0.650	0.700
Core Diameter	D3	3.100	3.300
Hub Recess Inner Diameter	D4	2.700	3.100
Hub Recess Depth	W1	0.370	0.570
Flange to Flange Inner Width	W2	1.630	1.690
Hub to Hub Center Width	W3		2.090

Note: All dimensions are in inches

TO-226AE Package Dimensions



TO-226AE (FS PKG Code 95, 99)

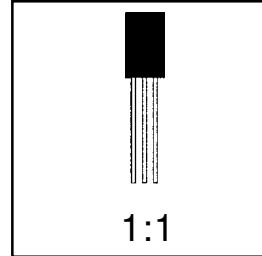
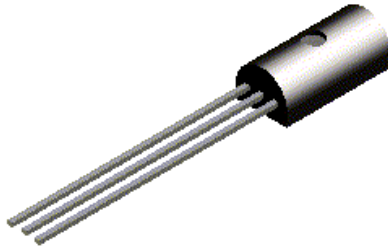

Scale 1:1 on letter size paper

Dimensions shown below are in:
inches [millimeters]

Part Weight per unit (gram): 0.300

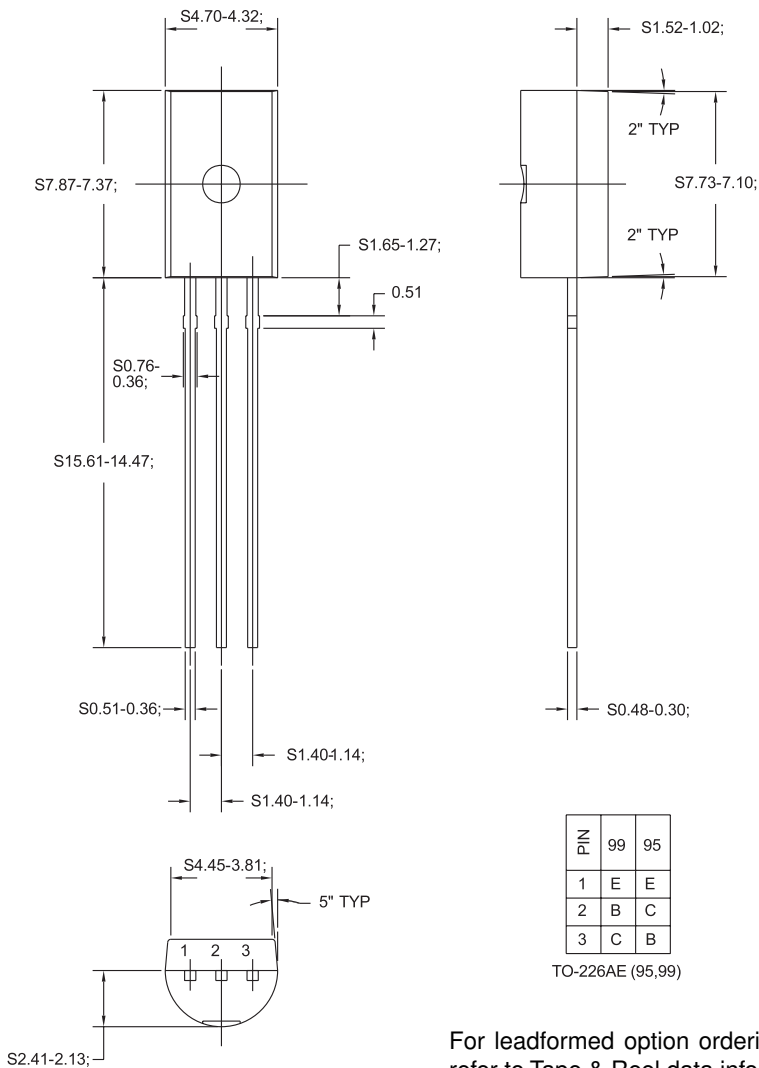

DIN	99	95
1	E	E
2	B	C
3	C	B

TO-226AE (95,99)

For leadformed option ordering,
refer to Tape & Reel data information.

TRADEMARKS

The following are registered and unregistered trademarks Fairchild Semiconductor owns or is authorized to use and is not intended to be an exhaustive list of all such trademarks.

ACEx™	FASTr™	PowerTrench®	SyncFET™
Bottomless™	GlobalOptoisolator™	QFET™	TinyLogic™
CoolFET™	GTO™	QST™	UHC™
CROSSVOLT™	HiSeC™	QT Optoelectronics™	VCX™
DOME™	ISOPLANAR™	Quiet Series™	
E ² CMOS™	MICROWIRE™	SILENT SWITCHER®	
EnSigna™	OPTOLOGIC™	SMART START™	
FACT™	OPTOPLANAR™	SuperSOT™-3	
FACT Quiet Series™	PACMAN™	SuperSOT™-6	
FAST®	POP™	SuperSOT™-8	

DISCLAIMER

FAIRCHILD SEMICONDUCTOR RESERVES THE RIGHT TO MAKE CHANGES WITHOUT FURTHER NOTICE TO ANY PRODUCTS HEREIN TO IMPROVE RELIABILITY, FUNCTION OR DESIGN. FAIRCHILD DOES NOT ASSUME ANY LIABILITY ARISING OUT OF THE APPLICATION OR USE OF ANY PRODUCT OR CIRCUIT DESCRIBED HEREIN; NEITHER DOES IT CONVEY ANY LICENSE UNDER ITS PATENT RIGHTS, NOR THE RIGHTS OF OTHERS.

LIFE SUPPORT POLICY

FAIRCHILD'S PRODUCTS ARE NOT AUTHORIZED FOR USE AS CRITICAL COMPONENTS IN LIFE SUPPORT DEVICES OR SYSTEMS WITHOUT THE EXPRESS WRITTEN APPROVAL OF FAIRCHILD SEMICONDUCTOR CORPORATION. As used herein:

1. Life support devices or systems are devices or systems which, (a) are intended for surgical implant into the body, or (b) support or sustain life, or (c) whose failure to perform when properly used in accordance with instructions for use provided in the labeling, can be reasonably expected to result in significant injury to the user.
2. A critical component is any component of a life support device or system whose failure to perform can be reasonably expected to cause the failure of the life support device or system, or to affect its safety or effectiveness.

PRODUCT STATUS DEFINITIONS

Definition of Terms

Datasheet Identification	Product Status	Definition
Advance Information	Formative or In Design	This datasheet contains the design specifications for product development. Specifications may change in any manner without notice.
Preliminary	First Production	This datasheet contains preliminary data, and supplementary data will be published at a later date. Fairchild Semiconductor reserves the right to make changes at any time without notice in order to improve design.
No Identification Needed	Full Production	This datasheet contains final specifications. Fairchild Semiconductor reserves the right to make changes at any time without notice in order to improve design.
Obsolete	Not In Production	This datasheet contains specifications on a product that has been discontinued by Fairchild semiconductor. The datasheet is printed for reference information only.