



Chipsmall Limited consists of a professional team with an average of over 10 year of expertise in the distribution of electronic components. Based in Hongkong, we have already established firm and mutual-benefit business relationships with customers from,Europe,America and south Asia,supplying obsolete and hard-to-find components to meet their specific needs.

With the principle of “Quality Parts,Customers Priority,Honest Operation,and Considerate Service”,our business mainly focus on the distribution of electronic components. Line cards we deal with include Microchip,ALPS,ROHM,Xilinx,Pulse,ON,Everlight and Freescale. Main products comprise IC,Modules,Potentiometer,IC Socket,Relay,Connector.Our parts cover such applications as commercial,industrial, and automotives areas.

We are looking forward to setting up business relationship with you and hope to provide you with the best service and solution. Let us make a better world for our industry!



## Contact us

Tel: +86-755-8981 8866 Fax: +86-755-8427 6832

Email & Skype: info@chipsmall.com Web: www.chipsmall.com

Address: A1208, Overseas Decoration Building, #122 Zhenhua RD., Futian, Shenzhen, China





# TND315S

## Excellent Power Device Dual buffer driver for general purpose, Dual SOIC8

ON Semiconductor®

<http://onsemi.com>

### Features

- Dual buffer
- Withstand voltage of 25V is assured
- Peak output current : 1A
- Fully compatible input to TTL / CMOS (VIH=up to 2.6V, at VDD=4.5 to 25V)
- Monolithic structure (High voltage CMOS process adopted)
- Wide range of operating voltage : 4.5V to 25V
- Fast switching time (30ns typical at 1000pF load)
- Built-in input pull-down resistance

### Specifications

Absolute Maximum Ratings at Ta=25°C

Parameter	Symbol	Conditions	Ratings	Unit
Supply Voltage	VDD		0 to 25	V
Input Voltage	VIN		GND -0.3 to VDD+0.3	V
Allowable Power Dissipation	PD max		0.3	V
Junction Temperature	Tj		-55 to 150	°C
Storage Temperature	Tstg		-55 to 150	°C

Stresses exceeding Maximum Ratings may damage the device. Maximum Ratings are stress ratings only. Functional operation above the Recommended Operating Conditions is not implied. Extended exposure to stresses above the Recommended Operating Conditions may affect device reliability.

### Package Dimensions

unit : mm (typ)  
7072-005

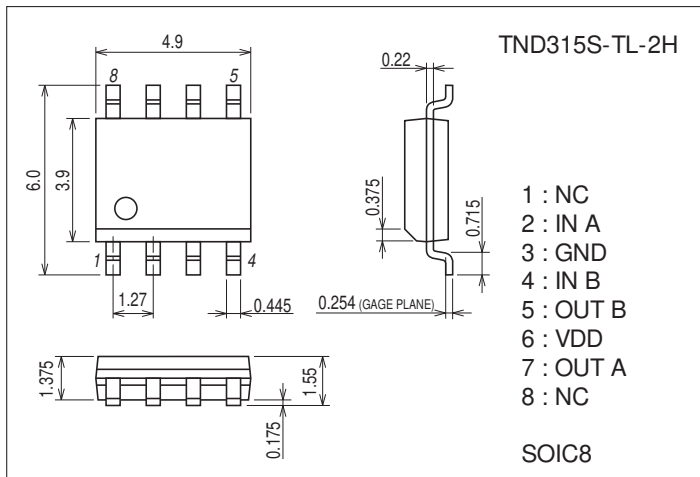

### Product & Package Information

- Package : SOIC8
- JEITA, JEDEC : SC-87, SOT-96
- Minimum Packing Quantity : 2,500 pcs./reel

### Packing Type: TL

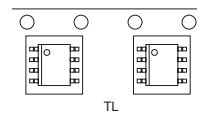

### Marking

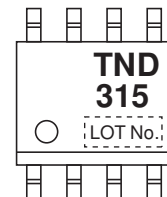

### Block Diagram

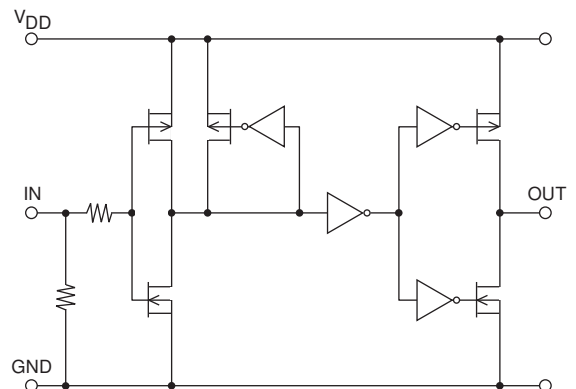

# TND315

## Recommend Operating Conditions at Ta=25°C

Parameter	Symbol	Conditions	Ratings	Unit
Operating Supply Voltage	V <sub>DD</sub>		4.5 to 25	V
Operating Temperature	Topr		-40 to +125	°C

## Electrical Characteristics (AC Characteristics) at Ta=25°C, V<sub>DD</sub>=18V, V<sub>IN</sub>=5V

Parameter	Symbol	Conditions	Ratings			Unit
			min	typ	max	
Turn-ON Rise Time	t <sub>r</sub>	C <sub>L</sub> =1000pF		30	45	ns
Turn-OFF Fall Time	t <sub>f</sub>	C <sub>L</sub> =1000pF		30	45	ns
Delay Time	t <sub>D1</sub>	C <sub>L</sub> =1000pF		30	45	ns
	t <sub>D2</sub>	C <sub>L</sub> =1000pF		45	60	ns

## Electrical Characteristics (DC Characteristics) at Ta=25°C, V<sub>DD</sub>=4.5 to 25V

Parameter	Symbol	Conditions	Ratings			Unit
			min	typ	max	
Logic "1" Input Voltage	V <sub>IH</sub>		2.6			V
Logic "0" Input Voltage	V <sub>IL</sub>				0.8	V
Logic "1" Input Bias Current	I <sub>IN+</sub>	V <sub>IN</sub> =V <sub>DD</sub> =25V		40	100	μA
Logic "0" Input Bias Current	I <sub>IN-</sub>	V <sub>IN</sub> =0V or V <sub>DD</sub>	-1		1	μA
High Level Output Voltage	V <sub>OH</sub>	I <sub>O</sub> =0A	V <sub>DD</sub> -0.1			V
Low Level Output Voltage	V <sub>OL</sub>	I <sub>O</sub> =0A			0.1	V
V <sub>DD</sub> Supply Current	I <sub>supp</sub>	V <sub>DD</sub> =10V, V <sub>IN</sub> =3V, (both inputs)		1.0	4.5	mA
		V <sub>DD</sub> =10V, V <sub>IN</sub> =0V, (both inputs)			0.2	mA
Output High Short Circuit Pulse Current	I <sub>O+</sub>	V <sub>DD</sub> =18V, P <sub>W</sub> ≤10μs, V <sub>OUT</sub> =0V		1.0		A
Output Low Short Circuit Pulse Current	I <sub>O-</sub>	V <sub>DD</sub> =18V, P <sub>W</sub> ≤10μs, V <sub>OUT</sub> =18V		1.0		A
Output On Resistance	R <sub>OUT</sub>	V <sub>DD</sub> =18V, I <sub>load</sub> =10mA, V <sub>OUT</sub> ="H"		8	12	Ω
		V <sub>DD</sub> =18V, I <sub>load</sub> =10mA, V <sub>OUT</sub> ="L"		6	10	Ω

## Switching Time Test Circuit

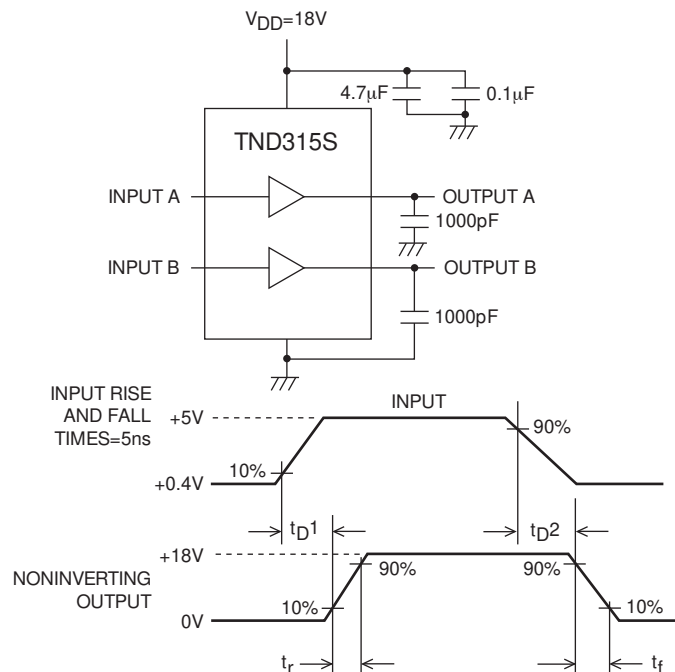

## Ordering Information

Devices	Package	Shipping	memo
TND315S-TL-2H	SOIC8	2,500pcs./reel	Pb Free and Halogen Free

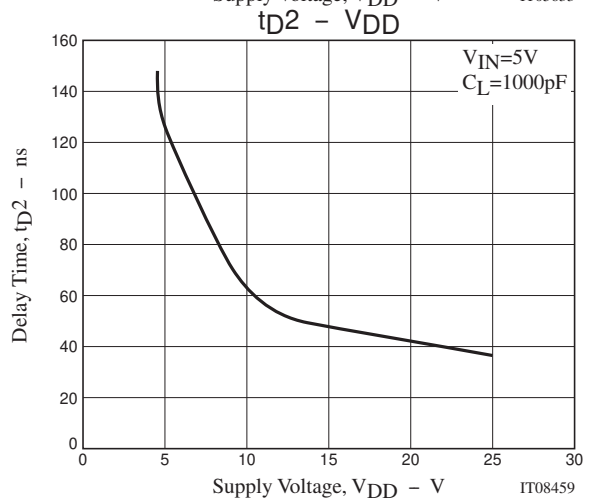
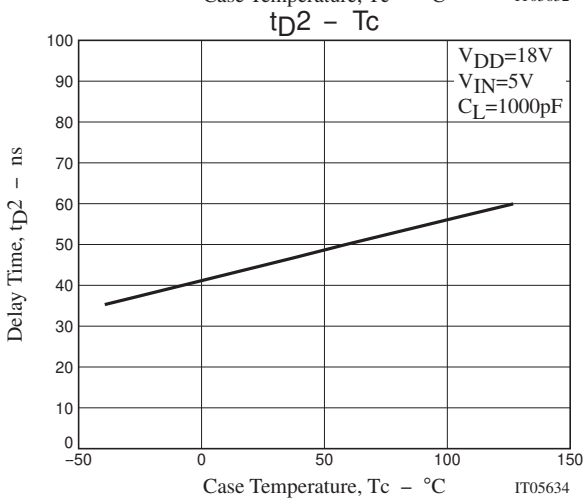
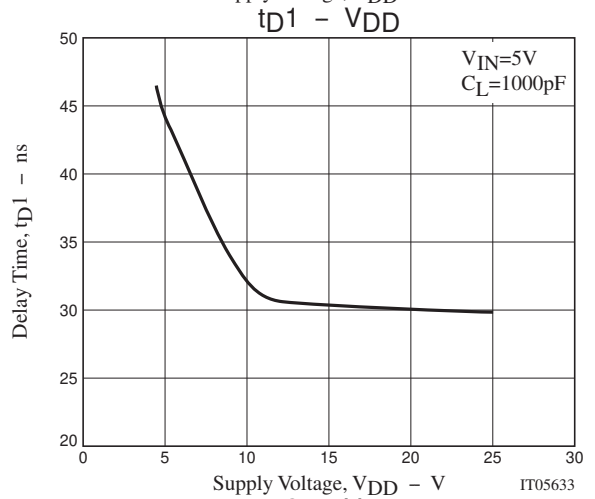
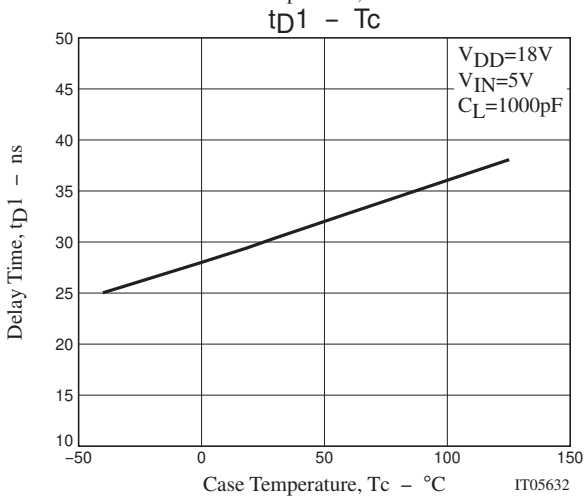
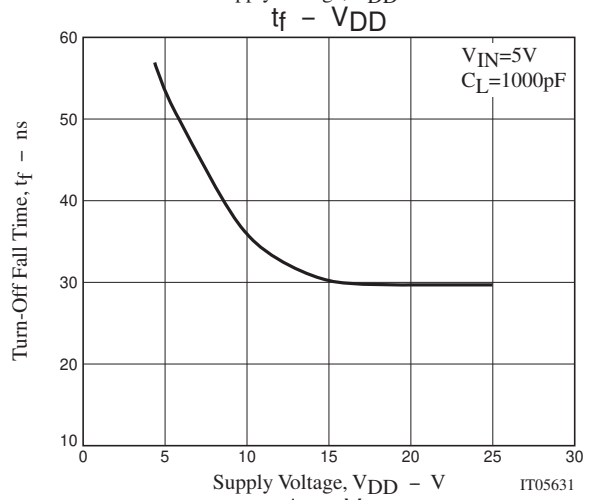
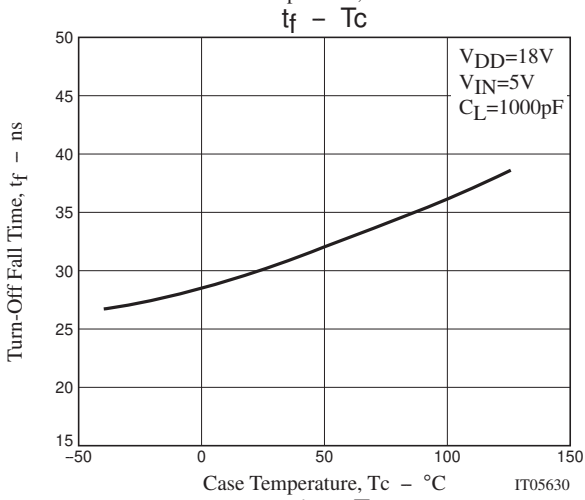
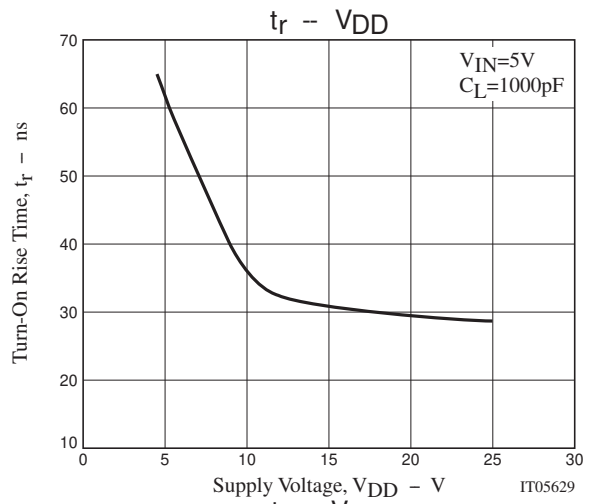
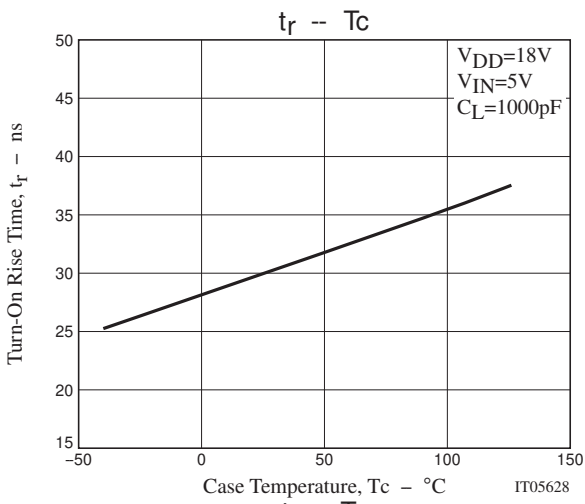

# TND315

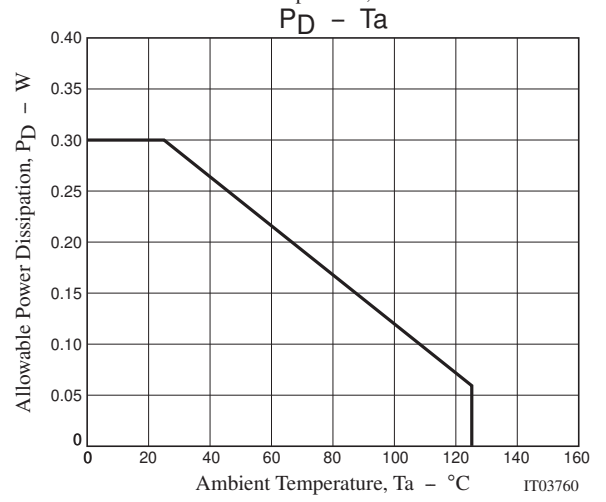
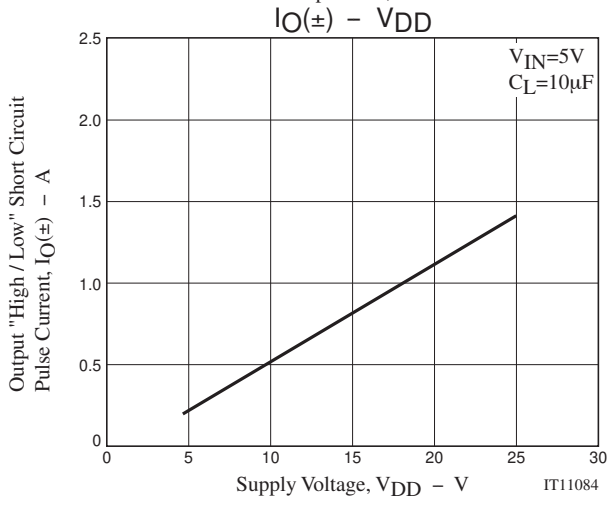
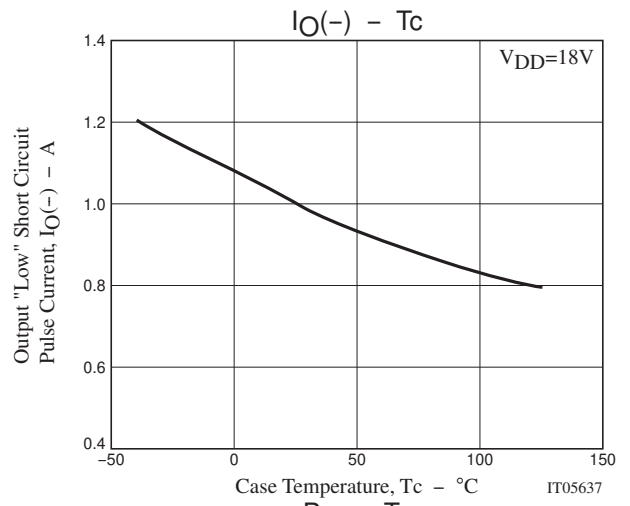
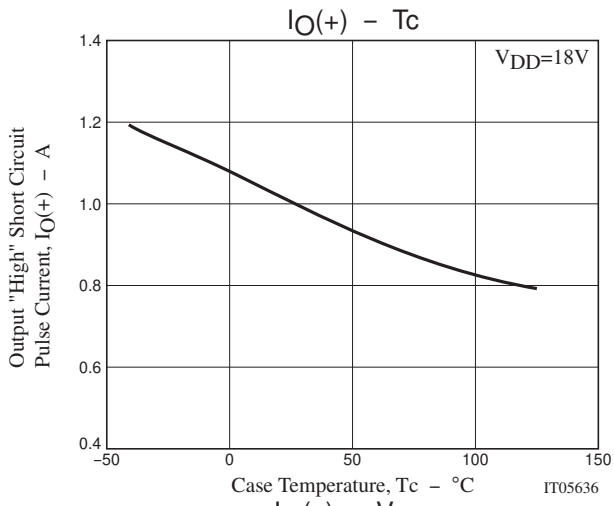

# TND315

## Taping Specification

TND315S-TL-2H

### 1. Packing Format

Package Name	Carrier Tape Type	Maximum Number of devices contained (pcs)			Packing format	
		Reel	Inner box	Outer box	Inner BOX W206-112	Outer BOX W207-124
SOIC8	B202-101	2,500	12,500	25,000	5 reels contained Dimensions :mm(external) 340×95×340	2 inner boxes contained Dimensions :mm(external) 360×210×375

#### Packing method

#### Reel label, Inner box label (unit: mm)

#### Outer box label

It is a label at the time of factory shipments.  
The form of a label may change in physical distribution process.

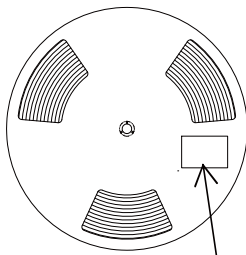

Type No. →  
LOT No. →  
Quantity →  
Origin →

Reel label

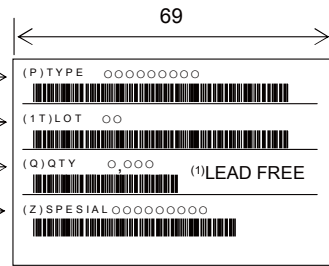

NOTE(1)

The LEAD FREE 4 description shows that it is complete lead free.

43  
80

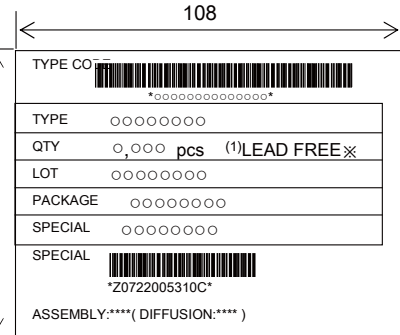

Label	JEITA Phase
LEAD FREE 4	JEITA Phase 3

# TND315

## 2. Taping configuration

### 2-1. Carrier tape size (unit: mm)

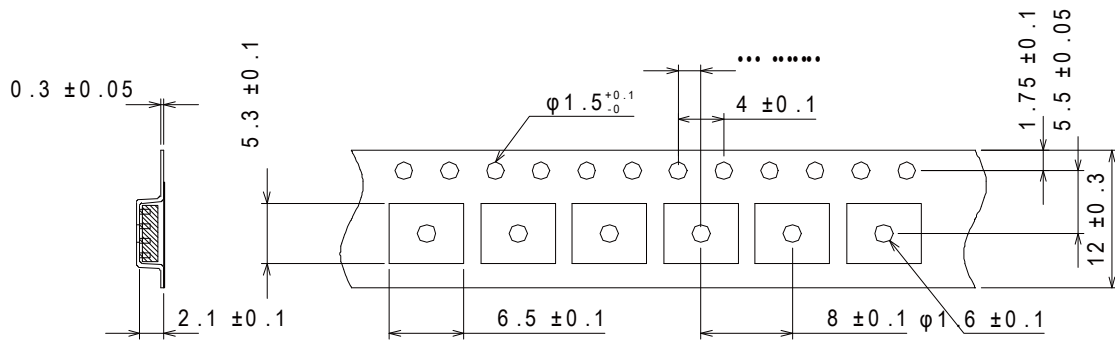

### 2-2. Device placement direction

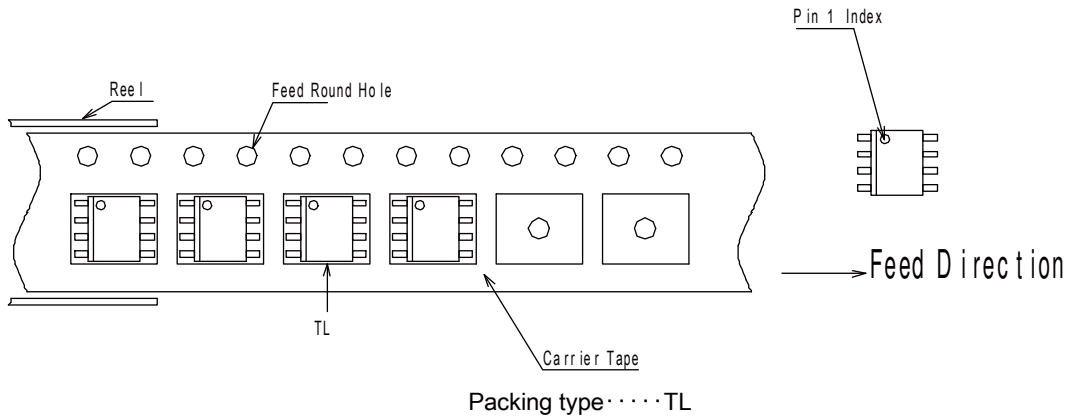

### 2-3. Leader portion and trailer portion (unit: mm)

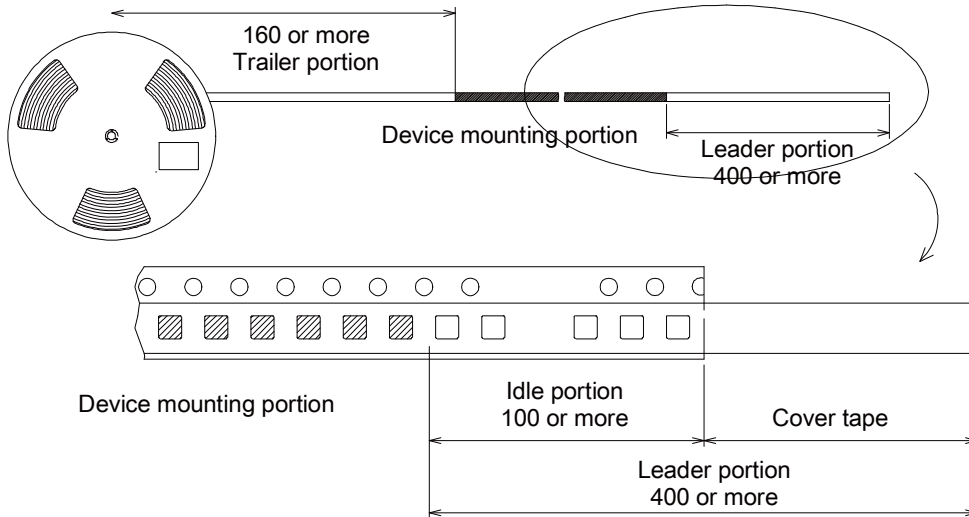

# TND315

## Outline Drawing

TND315S-TL-2H

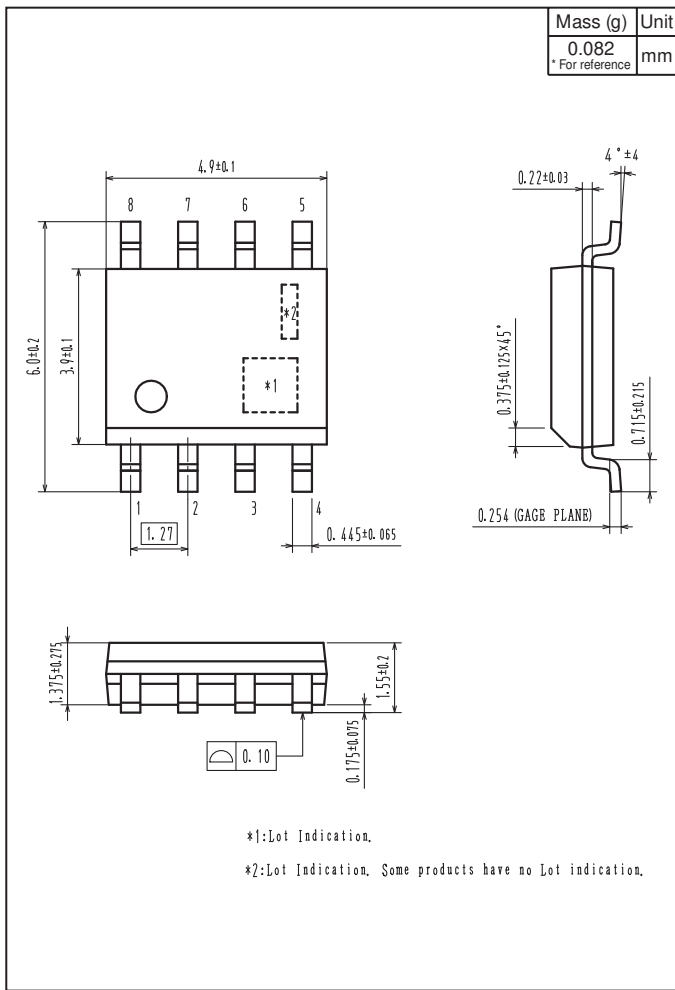

## Land Pattern Example

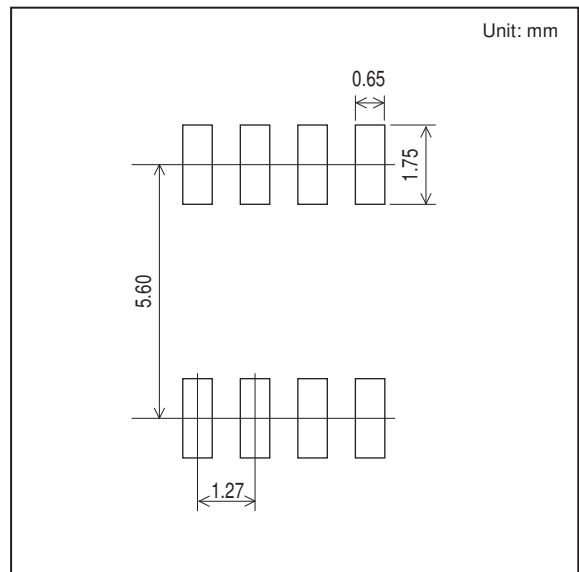



ON Semiconductor and the ON logo are registered trademarks of Semiconductor Components Industries, LLC (SCILLC). SCILLC owns the rights to a number of patents, trademarks, copyrights, trade secrets, and other intellectual property. A listing of SCILLC's product/patent coverage may be accessed at [www.onsemi.com/site/pdf/Patent-Marking.pdf](http://www.onsemi.com/site/pdf/Patent-Marking.pdf). SCILLC reserves the right to make changes without further notice to any products herein. SCILLC makes no warranty, representation or guarantee regarding the suitability of its products for any particular purpose, nor does SCILLC assume any liability arising out of the application or use of any product or circuit, and specifically disclaims any and all liability, including without limitation special, consequential or incidental damages. "Typical" parameters which may be provided in SCILLC data sheets and/or specifications can and do vary in different applications and actual performance may vary over time. All operating parameters, including "Typicals" must be validated for each customer application by customer's technical experts. SCILLC does not convey any license under its patent rights nor the rights of others. SCILLC products are not designed, intended, or authorized for use as components in systems intended for surgical implant into the body, or other applications intended to support or sustain life, or for any other application in which the failure of the SCILLC product could create a situation where personal injury or death may occur. Should Buyer purchase or use SCILLC products for any such unintended or unauthorized application, Buyer shall indemnify and hold SCILLC and its officers, employees, subsidiaries, affiliates, and distributors harmless against all claims, costs, damages, and expenses, and reasonable attorney fees arising out of, directly or indirectly, any claim of personal injury or death associated with such unintended or unauthorized use, even if such claim alleges that SCILLC was negligent regarding the design or manufacture of the part. SCILLC is an Equal Opportunity/Affirmative Action Employer. This literature is subject to all applicable copyright laws and is not for resale in any manner.