



Chipsmall Limited consists of a professional team with an average of over 10 year of expertise in the distribution of electronic components. Based in Hongkong, we have already established firm and mutual-benefit business relationships with customers from,Europe,America and south Asia,supplying obsolete and hard-to-find components to meet their specific needs.

With the principle of "Quality Parts,Customers Priority,Honest Operation,and Considerate Service",our business mainly focus on the distribution of electronic components. Line cards we deal with include Microchip,ALPS,ROHM,Xilinx,Pulse,ON,Everlight and Freescale. Main products comprise IC,Modules,Potentiometer,IC Socket,Relay,Connector.Our parts cover such applications as commercial,industrial, and automotives areas.

We are looking forward to setting up business relationship with you and hope to provide you with the best service and solution. Let us make a better world for our industry!



## Contact us

Tel: +86-755-8981 8866 Fax: +86-755-8427 6832

Email & Skype: info@chipsmall.com Web: www.chipsmall.com

Address: A1208, Overseas Decoration Building, #122 Zhenhua RD., Futian, Shenzhen, China



# Telpower® High Current Switch

# TPHCS

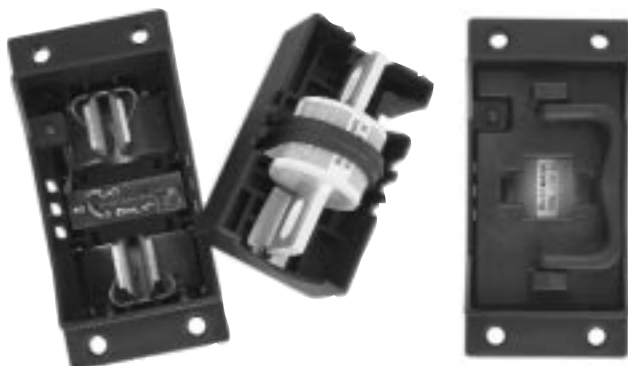

TPHCS800-MAV (shown)

## TPHCS

### Telpower® High Current Switch

For use with Telpower® Fuses Type TPL-B AND TPL-C.

#### Patents Pending

**Ampere Ratings:** 70 to 800 Amperes

**Voltage Rating:** 80 Volts DC

**U.L. Withstand Rating:** 100,000A

#### Agency Information:

U.L. Recognized (investigated to U.L. 1801) as a disconnect switch for the interruption of load current by means of withdrawing the fuse carrier.

U.L. Recognized to meet the requirements for Canadian Standards.

#### General Information:

- Innovative new design eliminates need for tools to replace the Telpower® type TPL-B or TPL-C fuse.
- Easy to install—captive fasteners allow for direct busbar mounting (bolts not included).
- Optional new electronic alarm provides both local and remote open-fuse indications.
  - Bipolar alarm designed for both Central Office and Radio applications.
  - Local LED alarm indication for ease-of-viewing.
  - Standard ¼" male quick-connect terminal for effortless remote alarm connection (Maximum remote alarm current: 20mA).
  - Eliminates need for parallel indicating fuses.
- Fuse presence window allows for easy viewing of installed fuse ampere rating.
- Compact design for today's high power, high-density cabinets.
- Available as complete switch or pullout and base may be purchased separately.

### Part Number System—Switches (Pullout and Base)

To identify part number, replace block with appropriate suffix to identify amperage, thread type, and alarm option.



#### Ampere (select one)

- 250 - For Use With 70 to 250 Amp Type TPL-B Fuses
- 800 - For Use With 300 to 800 Amp Type TPL-C Fuses

#### Thread (select one)

- M - Metric, M8 x 1.25
- E - English, 5/16 - 18

#### Alarm (leave blank for non-alarming version)

- L - LED Only, Requires Input From Customer Alarm Circuit
- \*AV - Alarm, System Voltage

\*Consult factory for availability

### Part Number System—Bases

To identify part number, replace block with appropriate suffix to identify thread type, and alarm option.

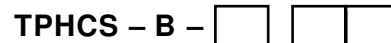

#### Thread (select one)

- M - Metric, M8 x 1.25
- E - English, 5/16 - 18

#### Alarm (leave blank for non-alarming version)

- L - LED Only, Requires Input From Customer Alarm Circuit
- \*AV - Alarm, System Voltage

\*Consult factory for availability

Catalog Numbers-Switches (Pullout and Base)		Series Fuse	Ampere Rating
TPHCS250-M	High Current Switch, Metric	TPL-B	70 to 250 Amp
TPHCS250-E	High Current Switch, English	TPL-B	70 to 250 Amp
TPHCS250-ML	High Current Switch, Metric, LED	TPL-B	70 to 250 Amp
TPHCS250-EL	High Current Switch, English, LED	TPL-B	70 to 250 Amp
TPHCS250-MAV	High Current Switch, Metric, Alarm	TPL-B	70 to 250 Amp
TPHCS250-EAV	High Current Switch, English, Alarm	TPL-B	70 to 250 Amp
TPHCS800-M	High Current Switch, Metric	TPL-C	300 to 800 Amp
TPHCS800-E	High Current Switch, English	TPL-C	300 to 800 Amp
TPHCS800-ML	High Current Switch, Metric, LED	TPL-C	300 to 800 Amp
TPHCS800-EL	High Current Switch, English, LED	TPL-C	300 to 800 Amp
TPHCS800-MAV	High Current Switch, Metric, Alarm	TPL-C	300 to 800 Amp
TPHCS800-EAV	High Current Switch, English, Alarm	TPL-C	300 to 800 Amp

Catalog Numbers - Components		Series Fuse	Ampere Rating
TPHCS250-P	Pullout only - 250 A	TPL-B	70 to 250 Amp
TPHCS800-P	Pullout only - 800 A	TPL-C	300 to 800 Amp
TPHCS-B-M	Base only, Metric	—	800 Amp Max.
TPHCS-B-E	Base only, English	—	800 Amp Max.
TPHCS-B-ML	Base only, Metric, LED	—	800 Amp Max.
TPHCS-B-EL	Base only, English, LED	—	800 Amp Max.
TPHCS-B-MAV	Base only, Metric, Alarm	—	800 Amp Max.
TPHCS-B-EAV	Base only, English, Alarm	—	800 Amp Max.

# Telpower® High Current Switch

# TPHCS

## TPHCS □ -M & -E

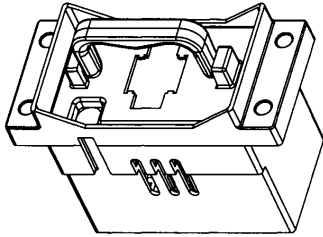

**NOTE:**  
1. TPHCS -M and -E are the same with the exception of thread type.

## TPHCS □ -ML & -EL

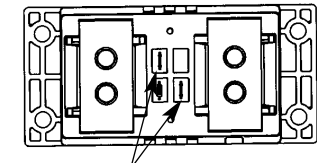
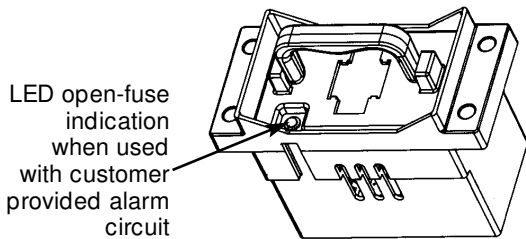

**BOTTOM VIEW**

LED alarm connections 1/4" male quick connects.

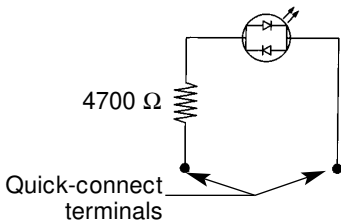

**LED CIRCUIT SCHEMATIC**

**NOTES:** 1. TPHCS -ML & -EL are the same with the exception of thread type.  
2. Maximum continuous LED current 20mA.

## TPHCS-Dimensional Data

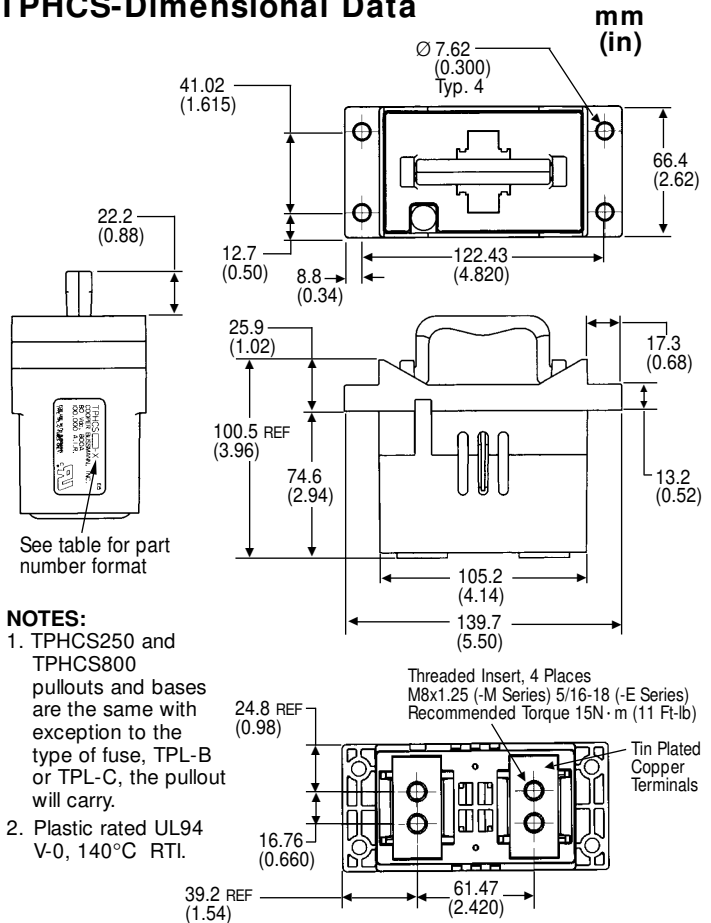

## TPHCS COMPONENTS

See Catalog Numbers for complete list

### PULLOUTS

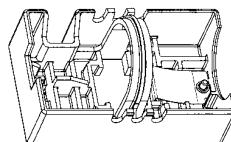

**TPHCS800-P**

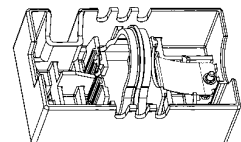

**TPHCS250-P**

### BASES

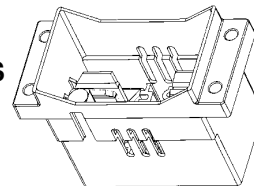

**TPHCS-B-M (shown for reference)**

The only controlled copy of this BIF document is the electronic read-only version located on the Bussmann Network Drive. All other copies of this BIF document are by definition uncontrolled. This bulletin is intended to clearly present comprehensive product data and provide technical information that will help the end user with design applications. Bussmann reserves the right, without notice, to change design or construction of any products and to discontinue or limit distribution of any products. Bussmann also reserves the right to change or update, without notice, any technical information contained in this bulletin. Once a product has been selected, it should be tested by the user in all possible applications.