



Chipsmall Limited consists of a professional team with an average of over 10 year of expertise in the distribution of electronic components. Based in Hongkong, we have already established firm and mutual-benefit business relationships with customers from,Europe,America and south Asia,supplying obsolete and hard-to-find components to meet their specific needs.

With the principle of "Quality Parts,Customers Priority,Honest Operation,and Considerate Service",our business mainly focus on the distribution of electronic components. Line cards we deal with include Microchip,ALPS,ROHM,Xilinx,Pulse,ON,Everlight and Freescale. Main products comprise IC,Modules,Potentiometer,IC Socket,Relay,Connector.Our parts cover such applications as commercial,industrial, and automotives areas.

We are looking forward to setting up business relationship with you and hope to provide you with the best service and solution. Let us make a better world for our industry!



## Contact us

Tel: +86-755-8981 8866 Fax: +86-755-8427 6832

Email & Skype: info@chipsmall.com Web: www.chipsmall.com

Address: A1208, Overseas Decoration Building, #122 Zhenhua RD., Futian, Shenzhen, China





**TT Series  
Remote Control and Sensor  
Transceiver  
Data Guide**

**Wireless made simple®**

**Warning:** Linx radio frequency ("RF") products may be used to control machinery or devices remotely, including machinery or devices that can cause death, bodily injuries, and/or property damage if improperly or inadvertently triggered, particularly in industrial settings or other applications implicating life-safety concerns. No Linx Technologies product is intended for use in any application without redundancies where the safety of life or property is at risk.

The customers and users of devices and machinery controlled with RF products must understand and must use all appropriate safety procedures in connection with the devices, including without limitation, using appropriate safety procedures to prevent inadvertent triggering by the user of the device and using appropriate security codes to prevent triggering of the remote controlled machine or device by users of other remote controllers.

**Do not use this or any Linx product to trigger an action directly from the data line or RSSI lines without a protocol or encoder/decoder to validate the data.** Without validation, any signal from another unrelated transmitter in the environment received by the module could inadvertently trigger the action.

**All RF products are susceptible to RF interference that can prevent communication.** RF products without frequency agility or hopping implemented are more subject to interference. This module does have a frequency hopping protocol built in, but the developer should still be aware of the risk of interference.

**Do not use any Linx product over the limits in this data guide.** Excessive voltage or extended operation at the maximum voltage could cause product failure. Exceeding the reflow temperature profile could cause product failure which is not immediately evident.

**Do not make any physical or electrical modifications to any Linx product.** This will void the warranty and regulatory and UL certifications and may cause product failure which is not immediately evident.

# Table of Contents

1	<a href="#">Description</a>
1	<a href="#">Features</a>
2	<a href="#">Ordering Information</a>
2	<a href="#">Electrical Specifications</a>
4	<a href="#">Absolute Maximum Ratings</a>
5	<a href="#">Transceiver Timings</a>
6	<a href="#">TRM-xxx-TT Typical Performance Graphs</a>
12	<a href="#">Pin Assignments</a>
12	<a href="#">Pin Descriptions</a>
14	<a href="#">Theory of Operation</a>
15	<a href="#">Module Description</a>
16	<a href="#">Basic Hardware Operation</a>
18	<a href="#">Transceiver Operation</a>
19	<a href="#">Transmit Operation</a>
19	<a href="#">Receive Operation</a>
20	<a href="#">The Pair Process</a>
21	<a href="#">Permissions Mask</a>
21	<a href="#">Acknowledgement</a>
22	<a href="#">Mode Indicator</a>
22	<a href="#">Reset to Factory Default</a>
23	<a href="#">Using the RSSI Line</a>
23	<a href="#">Using the LATCH_EN Line</a>
24	<a href="#">Using the Low Power Features</a>
24	<a href="#">Using the LVL_ADJ Line</a>
26	<a href="#">Receiver Duty Cycle</a>
27	<a href="#">Power Supply Requirements</a>
28	<a href="#">The Command Data Interface</a>
31	<a href="#">Frequency Hopping</a>
32	<a href="#">Usage Guidelines for FCC Compliance</a>

- 32 [Additional Testing Requirements](#)
- 33 [Information to the user](#)
- 34 [Product Labeling](#)
- 34 [FCC RF Exposure Statement](#)
- 34 [Antenna Selection](#)
- 36 [Typical Applications](#)
- 38 [Antenna Considerations](#)
- 39 [Helpful Application Notes from Linx](#)
- 40 [Interference Considerations](#)
- 41 [Pad Layout](#)
- 41 [Board Layout Guidelines](#)
- 43 [Microstrip Details](#)
- 44 [Production Guidelines](#)
- 44 [Hand Assembly](#)
- 44 [Automated Assembly](#)
- 46 [General Antenna Rules](#)
- 48 [Common Antenna Styles](#)
- 50 [Regulatory Considerations](#)

## TT Series Remote Control and Sensor Transceiver

# Data Guide



### Description

The TT Series transceiver is designed for reliable bi-directional, long-range remote control and sensor applications. It consists of a highly optimized Frequency Hopping Spread Spectrum (FHSS) RF transceiver and integrated remote control transcoder. The FHSS system allows higher power and, therefore, longer range than narrowband radios. The transceiver has obtained modular approval for the United States and Canada.

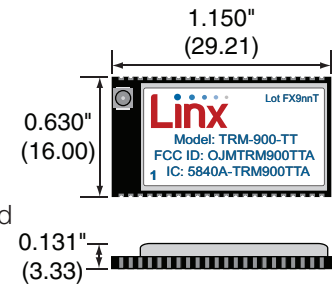

Figure 1: Package Dimensions

Eight status lines can be set up in any combination of inputs and outputs for the transfer of button or contact states. A selectable acknowledgement indicates that the transmission was successfully received. Operating in the 902 to 928MHz frequency band, the module achieves a typical sensitivity of -112dBm. The module is capable of generating +12.5dBm transmitter output power and achieves a range of over 2 miles (3.2 kilometers) line of site in typical environments with 0dB gain antennas.

Primary settings are hardware-selectable, which eliminates the need for an external microcontroller or other digital interface. For advanced features, optional software configuration is provided by a UART interface; however, no programming is required for basic operation. Housed in a compact reflow-compatible SMD package, the transceiver requires no external RF components except an antenna.

### Features

- FCC and Canada pre-certified
- 2 mile (3.2km) line of sight range
- Highly efficient power use
- Programmable receiver duty cycle
- No programming/tuning required
- 8 status lines, 2 byte data input
- Bi-directional remote control
- Selectable acknowledgements
- 2<sup>32</sup> possible addresses
- Serial interface for optional software operation

## Ordering Information

Ordering Information	
Part Number	Description
TRM-900-TT	900MHz TT Series Remote Control and Sensor Transceiver
EVM-900-TT	900MHz TT Series Evaluation Module
EVAL-900-TT	TT Series Basic Evaluation Kit
MDEV-900-TT	TT Series Master Development System

Transceivers are supplied in tubes of 18 pcs.

Figure 2: Ordering Information

## Electrical Specifications

TT Series Transceiver Specifications						
Parameter	Symbol	Min.	Typ.	Max.	Units	Notes
Power Supply						
Operating Voltage	$V_{CC}$	2.5		5.5	VDC	
Peak TX Supply Current	$I_{TX}$					
TT @ +12.5dBm			33.9	38.1	mA	1,2
TT @ 0dBm			15.2	18.9	mA	1,2
Average TX Supply Current						
TT @ +12.5dBm			21.3		mA	1,2
RX Supply Current	$I_{RX}$		18.8	23	mA	1,2
Standby Current	$I_{SBY}$		200		$\mu$ A	1,2
Power-Down Current	$I_{PDN}$			0.1	$\mu$ A	1,2
RF Section						
Operating Frequency Band	$F_C$	902		928	MHz	3
Number of Channels			25			3
Channel Spacing			500		kHz	3
Modulation Rate			45		kbps	

TT Series Transceiver Specifications						
Parameter	Symbol	Min.	Typ.	Max.	Units	Notes
Receiver Section						
Spurious Emissions		Per FCC 15.109				
Receiver Sensitivity		-110	-111		dBm	5
RSSI Dynamic Range			64		dB	
Transmitter Section						
Output Power	$P_O$	-15.5		+12.5	dBm	6
Output Power Control Range			28		dB	
Harmonic Emissions	$P_H$	Per FCC 15.109				
Antenna Port						
RF Impedance	$R_{IN}$		50		$\Omega$	
Environmental						
Operating Temp. Range		-40		+85	$^{\circ}$ C	
Storage Temp. Range		-55		+125	$^{\circ}$ C	
Timing						
Module Turn-On Time						
Via $V_{CC}$			8.0	80	ms	4,13
Via POWER_DOWN			8.0	80	ms	4,13
Via Standby			6.8		ms	4
Serial Command Response						
Factory Reset/Erase Table				620	ms	8
Write NV Parameter				16	ms	8
Write V/Read/Control				3	ms	8
IU to RU Status High		16		53	ms	7
Channel Dwell Time			12.3		ms	
Interface Section						
POWER_DOWN, ACK_EN						
Logic Low	$V_{IL}$			$V_{CC} * 0.2$	VDC	
Logic High	$V_{IH}$	$V_{CC} * 0.8$		$V_{CC}$	VDC	
Input						
Logic Low	$V_{IL}$			0.8	VDC	9
Logic Low	$V_{IL}$			$V_{CC} * 0.15$	VDC	10
Logic High	$V_{IH}$	2		5.5		9
Logic High	$V_{IH}$	$V_{CC} * 0.25 + 0.8$		4.5	VDC	10

TT Series Transceiver Specifications						
Parameter	Symbol	Min.	Typ.	Max.	Units	Notes
Output						
Logic Low	$V_{OL}$			0.6	VDC	11
Logic High	$V_{OH}$	$V_{CC}-0.7$		$V_{CC}$	VDC	12
Certifications						
Modular Certifications	FCC, Industry Canada					
1. Measured at 3.3V $V_{CC}$		9.	4.5 ≤ $V_{CC}$ ≤ 5.5			
2. Measured at 25°C		10.	$V_{CC}$ ≤ 4.5			
3. Guaranteed by design		11.	$I \leq 8\text{mA} @ V_{CC} \geq 5\text{V}; I \leq 6\text{mA} @ V_{CC} \geq 3.3\text{V}; I \leq 0.8\text{mA} @ V_{CC} \geq 2.5\text{V}$			
4. Characterized but not tested		12.	$I \leq 3.5\text{mA} @ V_{CC} \geq 5\text{V}; I \leq 3\text{mA} @ V_{CC} \geq 3.3\text{V}; I \leq 1\text{mA} @ V_{CC} \geq 2.5\text{V}$			
5. PER = 5%		13.	Maximum 80ms if $V_{CC} < 2.6\text{V}$			
6. Into a 50-ohm load						
7. No RF interference						
8. Response time is from end of command to start of response						

Figure 3: Electrical Specifications

## Absolute Maximum Ratings

Absolute Maximum Ratings				
Supply Voltage $V_{CC}$	-0.3	to	+5.5	VDC
Any Input or Output Pin	-0.3	to	$V_{CC} + 0.3$	VDC
RF Input			0	dBm
Operating Temperature	-40	to	+85	°C
Storage Temperature	-55	to	+125	°C

Exceeding any of the limits of this section may lead to permanent damage to the device. Furthermore, extended operation at these maximum ratings may reduce the life of this device.

Figure 4: Absolute Maximum Ratings

## Transceiver Timings

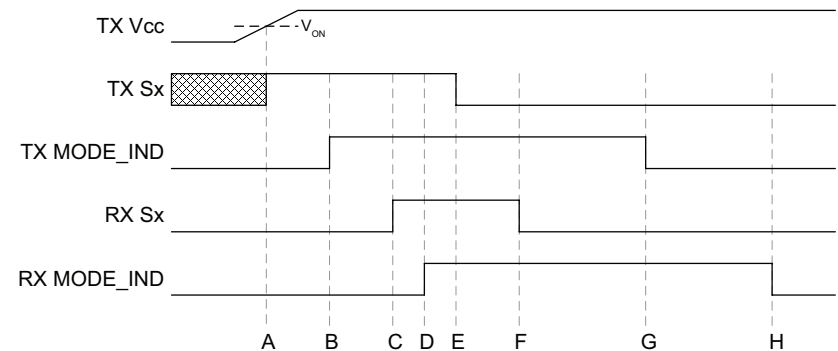

### TT Series Transceiver Timings

Item	Description	Minimum	Maximum
AB	TX Response from $V_{CC}$ or POWER_DOWN <sup>1,4</sup>		8ms
	TX Response from Status line while IU in idle <sup>2</sup>		12ms
	TX Response from Status line while IU / RU idle in RX <sup>3</sup>		1ms
BC	RX Initial Response	4ms	50ms
CD	Data Settle	4μs	8μs
EF	Data Update Delay During Active Session	5ms	25ms
EG	Shutdown Duration	25ms	342ms
GH	RX MODE_IND Drop	6ms	8ms

1. From module off to  $V_{CC}$  applied
2. The module is set as an IU only and is in idle pending status line activation
3. The module is set as an IU and RU and is idling in receive mode pending status line activation or receipt of a valid packet.
4. Maximum 80ms if  $V_{CC} < 2.6\text{V}$

Figure 5: TT Series Transceiver Timings

**Warning:** This product incorporates numerous static-sensitive components. Always wear an ESD wrist strap and observe proper ESD handling procedures when working with this device. Failure to observe this precaution may result in module damage or failure.

## TRM-xxx-TT Typical Performance Graphs

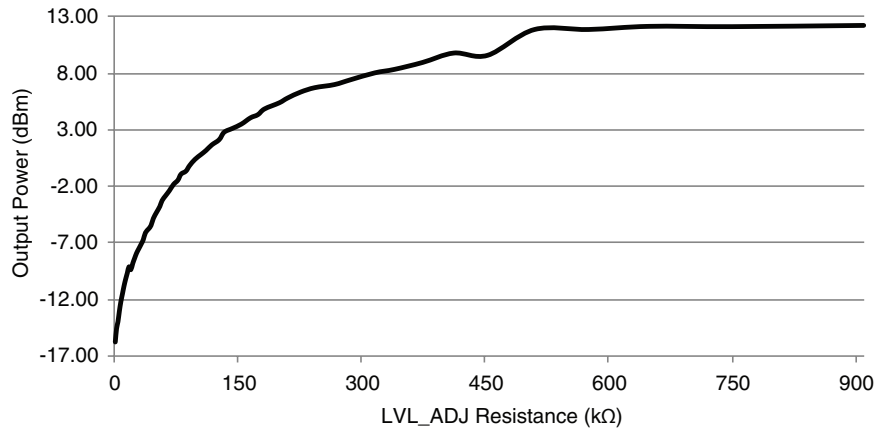

Figure 6: TT Series Transceiver Output Power vs. LVL\_ADJ Resistance

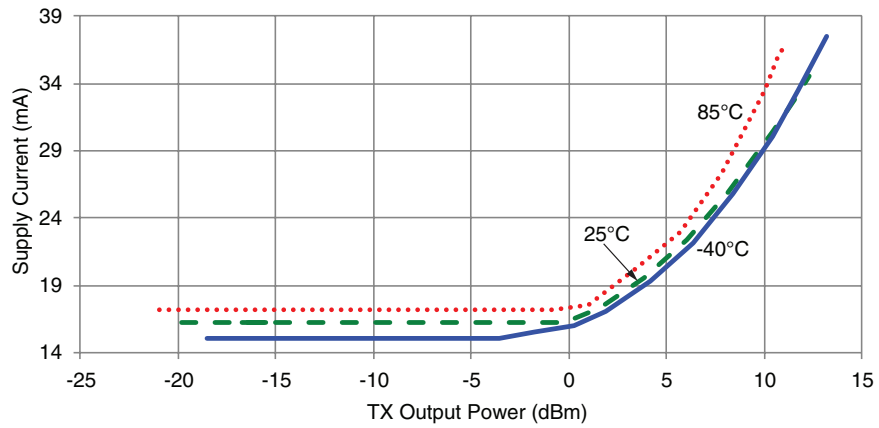

Figure 7: TT Series Transceiver Peak Current Consumption vs. Transmitter Output Power at 3.3V

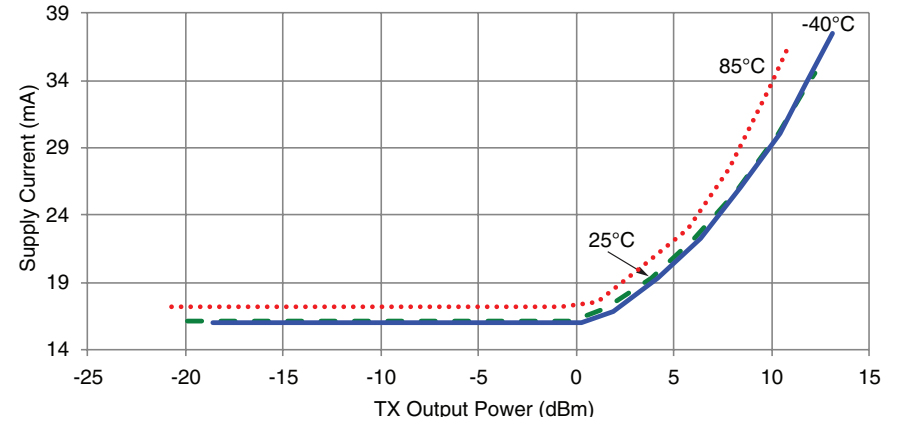

Figure 8: TT Series Transceiver Peak Current Consumption vs. Transmitter Output Power at 5.5V

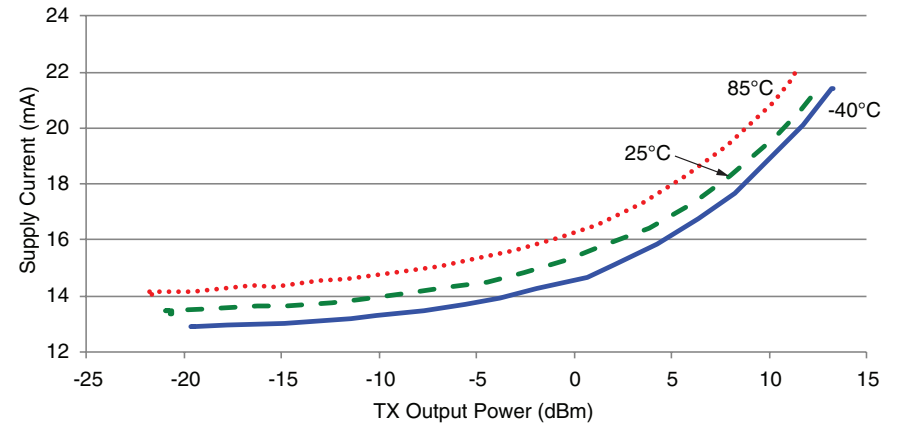

Figure 9: TT Series Transceiver Average Current Consumption vs. Transmitter Output Power at 3.3V

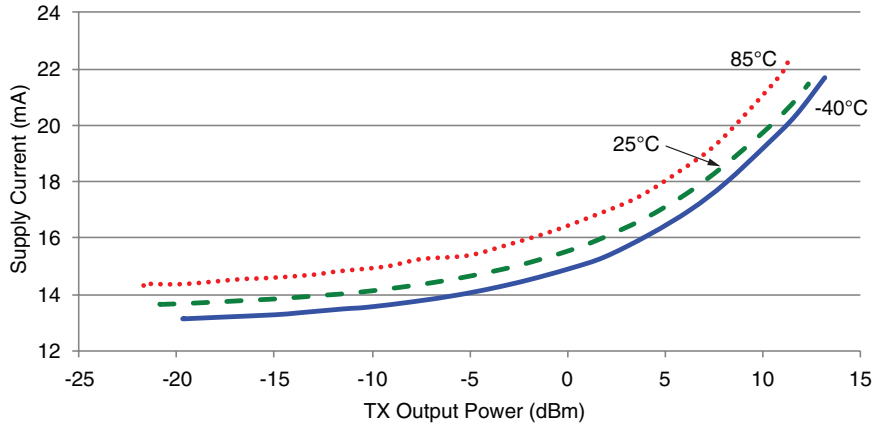

Figure 10: TT Series Transceiver Average Current Consumption vs. Transmitter Output Power at 5.5V

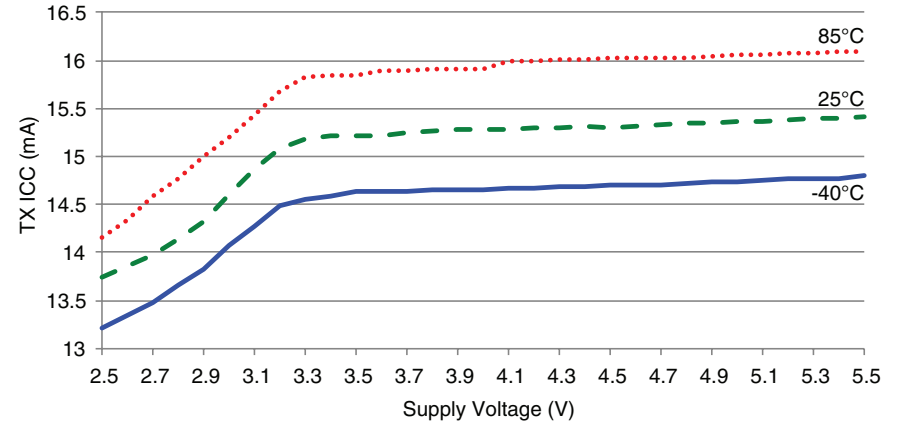

Figure 12: TT Series Transceiver TX Current Consumption vs. Supply Voltage at 0dBm

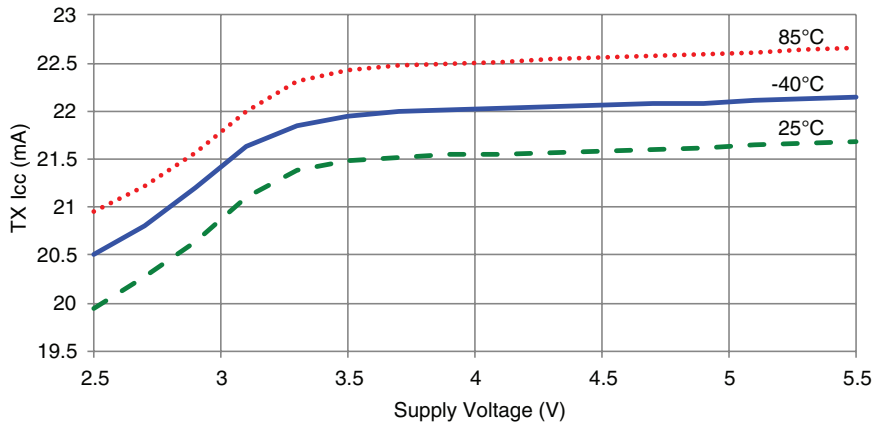

Figure 11: TT Series Transceiver TX Current Consumption vs. Supply Voltage at Max Power

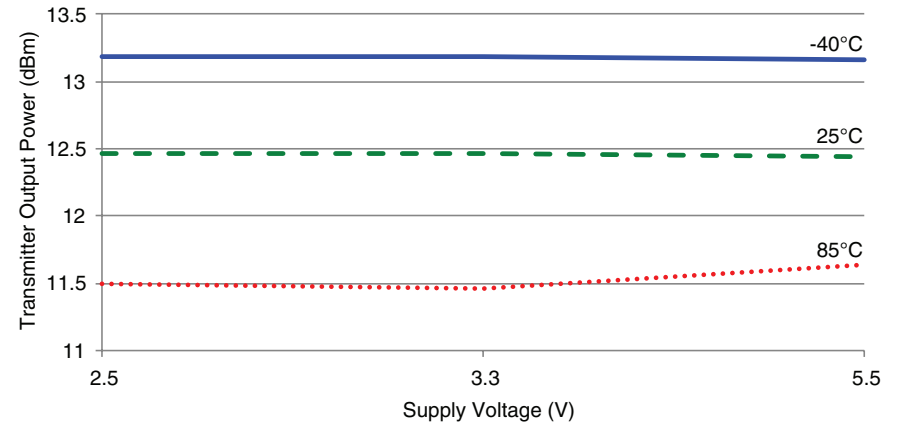

Figure 13: TT Series Transceiver Transmitter Output Power vs. Supply Voltage



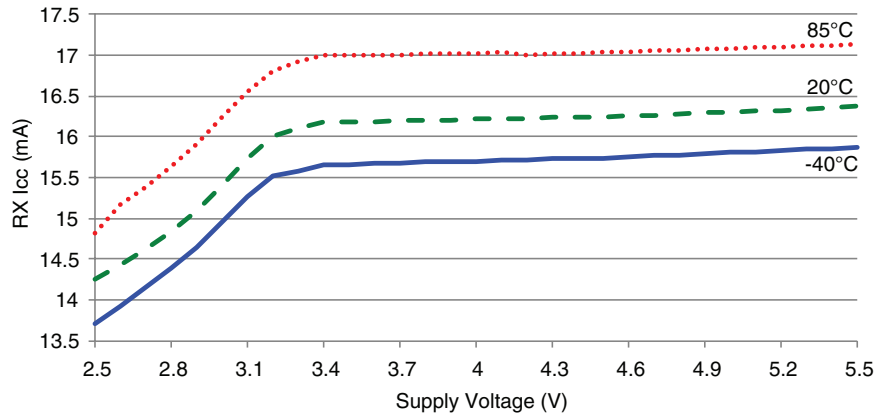

Figure 14: TT Series Transceiver RX Current Consumption vs. Supply Voltage

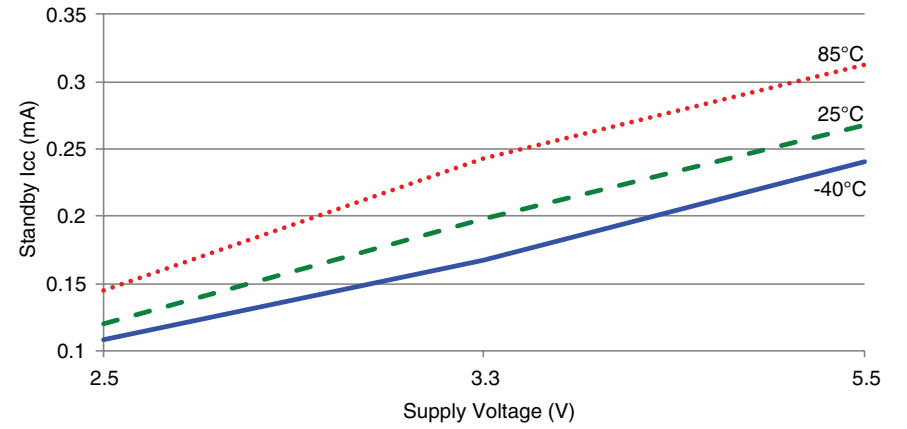

Figure 16: TT Series Transceiver Standby Current Consumption vs. Supply Voltage

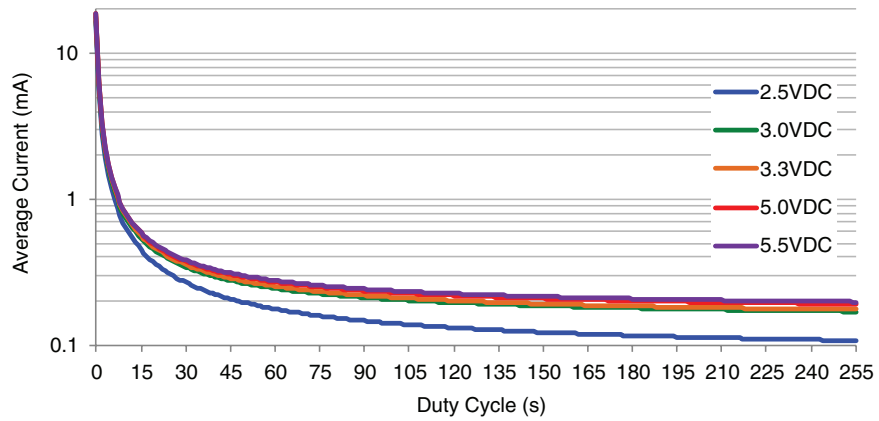

Figure 15: TT Series Transceiver Average RX Current Consumption vs. Duty Cycle

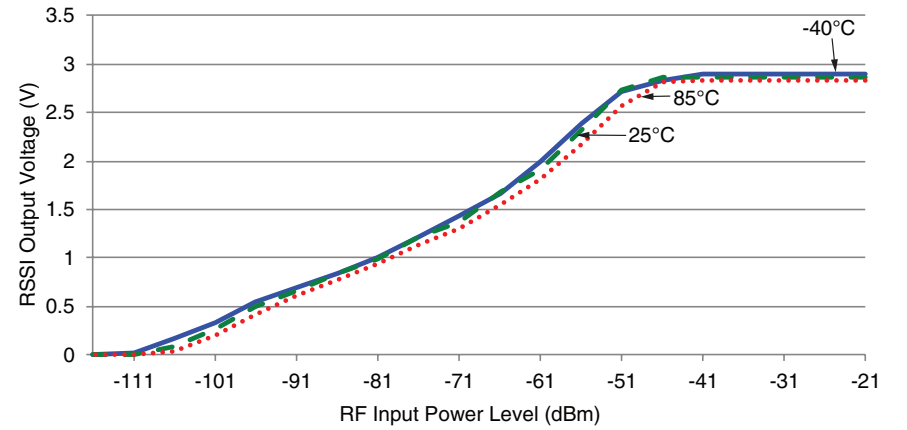

Figure 17: TT Series Transceiver RSSI Voltage vs. Input Power

## Pin Assignments

1	GND	GND	44
2	NC	ANTENNA	43
3	GND	GND	42
4	NC	NC	41
5	NC	NC	40
6	GND	GND	39
7	NC	NC	38
8	NC	NC	37
9	S0	ACK_EN	36
10	S1	MODE_IND	35
11	GND	GND	34
12	S2	PAIR	33
13	S3	C1	32
14	LVL_ADJ	ACK_OUT	31
15	LATCH_EN	C0	30
16	RESET	CMD_DATA_OUT	29
17	GND	GND	28
18	S7	CMD_DATA_IN	27
19	S6	S5	26
20	S4	VCC	25
21	RSSI	POWER_DOWN	24
22	GND	GND	23

Figure 18: TT Series Transceiver Pin Assignments (Top View)

## Pin Descriptions

Pin Descriptions			
Pin Number	Name	I/O	Description
1, 3, 6, 11, 17, 22, 23, 28, 34, 39, 42, 44	GND	—	Ground
2, 4, 5, 7, 8, 37, 38, 40, 41	NC	—	No Electrical Connection. Do not connect any traces to these lines.
9, 10, 12, 13, 18, 19, 20, 26	S0 - S7	I/O	Status Lines. Each line can be configured as either an input to register button or contact closures or as an output to control application circuitry.
14	LVL_ADJ <sup>1</sup>	I	Level Adjust. This line sets the transmitter output power level. Pull high or leave open for the highest power; connect to GND through a resistor to lower the power.

Pin Descriptions Continued			
Pin Number	Name	I/O	Description
15	LATCH_EN	I	If this line is high, then the status line outputs are latched (a received command to activate a status line toggles the output state). If this line is low, then the output lines are momentary (active for as long as a valid signal is received) and which are latched.
16	RESET	I	Pull low to perform a soft reset of the module. This line has an internal pull-up to POWER_DOWN, may be left unconnected
21	RSSI	O	Received Signal Strength Indicator. This line outputs an analog voltage that increases with the strength of the received signal. It is updated once a second.
24	POWER_DOWN	I	Power Down. Pulling this line low places the module into a low-power state. The module is not functional in this state. Pull high for normal operation. Do not leave floating.
25	VCC	—	Supply Voltage
27	CMD_DATA_IN	I	Command Data In. Input line for the serial interface commands
29	CMD_DATA_OUT	O	Command Data Out. Output line for the serial interface commands
30	C0	I	This line sets the input/output direction for status lines S0-S3. When low, the lines are outputs; when high they are inputs.
31	ACK_OUT	O	This line goes high when the module receives an acknowledgement message from another module after sending a control message.
32	C1	I	This line sets the input/output direction for status lines S4-S7. When low, the lines are outputs; when high they are inputs.
33	PAIR	I	A high on this line initiates the Pair process, which causes two units to accept each other's transmissions. It is also used with a special sequence to reset the module to factory default configuration.
35	MODE_IND	O	This line indicates module activity. It can source enough current to drive a small LED, causing it to flash. The duration of the flashes indicates the module's current state.
36	ACK_EN	I	Pull this line high to enable the module to send an acknowledgement message after a valid control message has been received.
43	ANTENNA	—	50-ohm RF Antenna Port

1. This line has an internal 100kΩ pull-up resistor

Figure 19: TT Series Transceiver Pin Descriptions

## Theory of Operation

The TT Series transceiver is a low-cost, high-performance synthesized FSK transceiver. Its exceptional sensitivity results in outstanding range performance. Figure 20 shows a block diagram for the module.

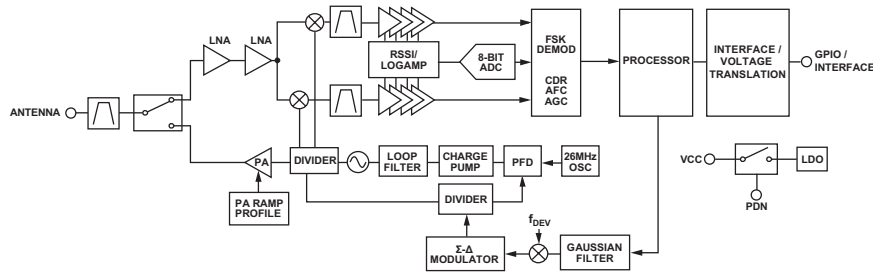

Figure 20: TT Series Transceiver RF Section Block Diagram

The TT Series transceiver is designed for operation in the 902 to 928MHz frequency band. The RF synthesizer contains a VCO and a low-noise fractional-N PLL. The VCO operates at twice the fundamental frequency to reduce spurious emissions. The receive and transmit synthesizers are integrated, enabling them to be automatically configured to achieve optimum phase noise, modulation quality and settling time.

The transmitter output power is programmable from  $-15.5\text{dBm}$  to  $+12.5\text{dBm}$  with automatic PA ramping to meet transient spurious specifications. The ramping and frequency deviation are optimized to deliver the highest performance over a wide range of data rates.

The receiver incorporates highly efficient low-noise amplifiers that provide up to  $-112\text{dBm}$  sensitivity. Advanced interference blocking makes the transceiver extremely robust when in the presence of interference.

A low-power onboard communications processor performs the radio control and management functions. A control processor performs the higher level functions and controls the serial and hardware interfaces. This block also includes voltage translation to allow the internal circuits to operate at a low voltage to conserve power while enabling the interface to operate over the full external voltage. This prevents hardware damage and communication errors due to voltage level differences.

While operation is recommended from 3.3V to 5.0V, the transceiver can operate down to 2.5V.

## Module Description

The TT Series remote control and sensor transceiver module is a completely integrated RF transceiver and processor. It has two main modes of operation: hardware and software. Hardware operation is basic and is suitable for applications like keyfobs where no other processor, PC or interface is present. Software operation is more advanced and allows for more features and functionality. This guide focuses on hardware operation with some references to software operation. Please see Reference Guide RG-00103: the TT Series Command Data Interface for details on software operation.

The module has 8 status lines numbered S0 through S7. These can be set as inputs for buttons or contacts or as outputs to drive application circuitry. When S0 is taken high on one module S0 goes high on the receiving module, and so forth. A line that is an input on one side needs to be set as an output on the other side.

Since this module can act as both transmitter and receiver, terminology and descriptions are important. This guide uses the term Initiating Unit (IU) to describe a module that is transmitting commands. Responding Unit (RU) is used to describe a module that is receiving commands.

The transceiver uses a Frequency Hopping Spread Spectrum (FHSS) algorithm. This allows for higher output power and longer range than narrow-band systems while still maintaining regulatory compliance. All aspects of managing the FHSS operations are automatically handled by the module.

The TT Series has received modular certification for the FCC in the United States and Industry Canada when used with an approved antenna. The module may be placed in an end product without further transmitter testing, though unintentional radiator testing may be required. Please see the Usage Guidelines for FCC Compliance section for more details.

## Basic Hardware Operation

The following steps describe how to use the TT Series module with hardware only. Basic application circuits that correspond to these steps are shown in Figure 21.

1. Set the C0 and C1 lines opposite on both sides.
2. Press the PAIR button on both sides. The MODE\_IND LED begins flashing slowly to indicate that the module is searching for another module.
3. Once the pairing is complete, the MODE\_IND LED flashes quickly to indicate that the pairing was successful.
4. The modules are now paired and ready for normal use.
5. Pressing a status line button on one module (the IU) activates the corresponding status line output on the second module (the RU).
6. Taking the ACK\_EN line high on the RU causes the module to send an acknowledgement to the IU. The ACK\_OUT line on the IU goes high to indicate that the acknowledgement has been received. Tying the line to  $V_{cc}$  causes the module to send an acknowledgement as soon as a command message is received.

This is suitable for basic remote control or command systems. No programming is necessary for basic hardware operation. The following sections describe the functions in more detail and the Typical Applications section shows additional example schematics for using the modules.

Sensor applications can replace the buttons with triggered outputs from sensors. A comparator circuit can be used to trigger a line when a sensor reading crosses a threshold, providing a warning or indication to a user.

The Command Data Interface section describes the more advanced features that are available with the serial interface.

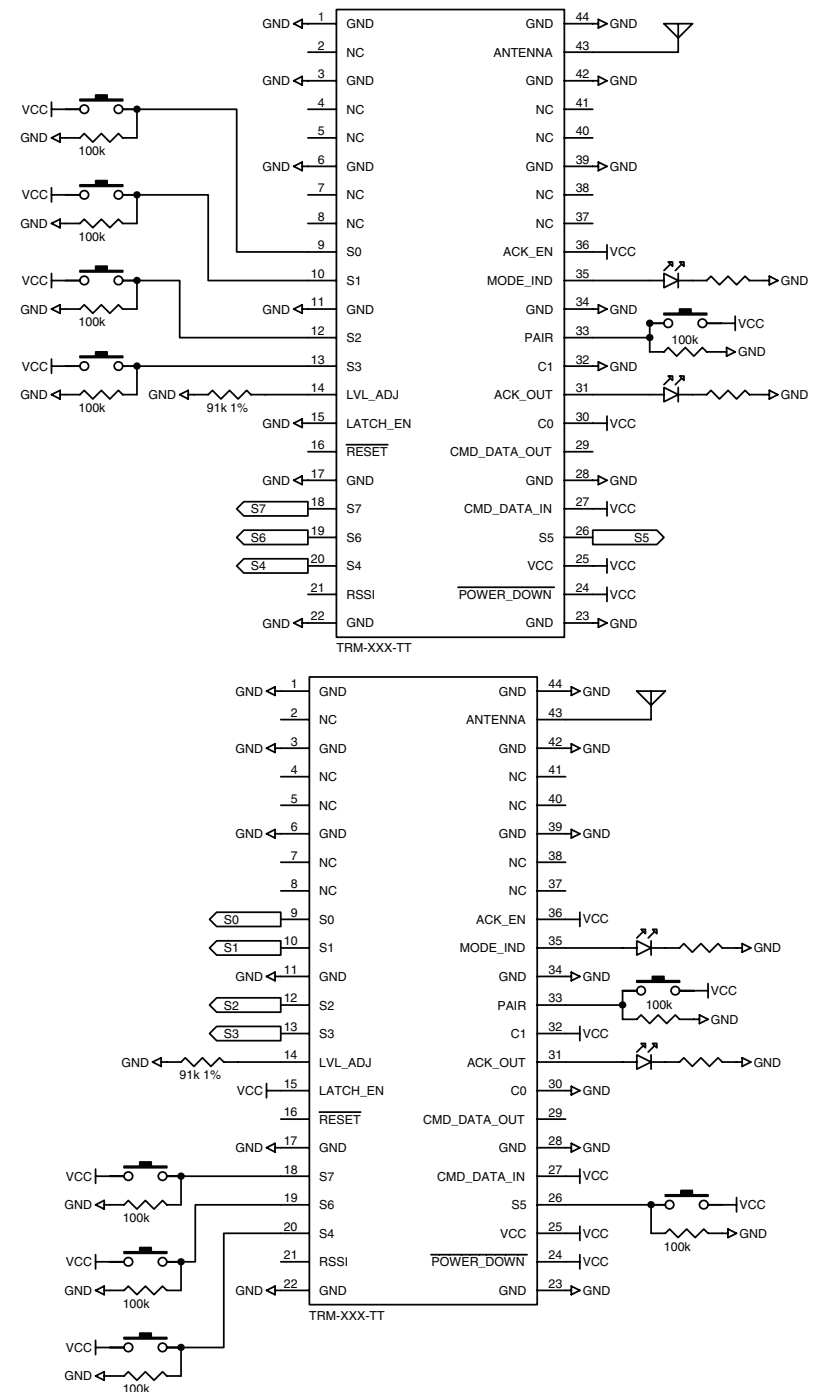

Figure 21: TT Series Transceiver Basic Application Circuits for Bi-directional Remote Control

## Transceiver Operation

The transceiver has two modes of operation: Initiating Unit (IU) that transmits control messages and Responding Unit (RU) that receives control messages. If all of the status lines are set as inputs, then the module is set as an IU only. The module stays in a low power sleep mode until a status line goes high, starting the Transmit Operation.

If all of the status lines are set as outputs, then the module is set as an RU only. It stays in Receive Operation looking for a valid transmission from a paired IU.

A module with both input and output status lines can operate as an IU and an RU. The module idles in Receive Operation until either a valid transmission is received or a status line input goes high, initiating the Transmit operation.

When an input goes high, the transceiver captures the logic state of each of the status lines. The line states are placed into a packet along with the local 32-bit address. The IU transmits the packets as it hops among 25 RF channels.

An RU receives the packet and checks its Paired Module List to see if the IU has been paired with the module and is authorized to control it. If the IU's address is not in the table, then the RU ignores the transmission. If the address is in the table, then the RU calculates the channel hopping pattern from the IU's address and sets its status line outputs according to the received packet. It then hops along with the IU and updates the states of its outputs with every packet. Its outputs can be connected to external circuitry that activates when the lines go high.

The RU can also send an acknowledgement back to the IU. Using the serial interface the RU can include up to two bytes of custom data with the acknowledgement, such as sensor data or battery voltage levels. Using the hardware control, if ACK\_EN is high when a valid control packet is received, the module sends back a simple acknowledgement (ACK). It sends an Acknowledge with Data (AWD) response when custom data is programmed into the module using a serial command.

## Transmit Operation

Transmit Operation is entered when any of the status line inputs go high. During Transmit Operation, the MODE\_IND line is high. The module repeatedly transmits control messages containing the local address and the state of all status lines. Between transmissions the module listens for acknowledgement messages. If an Acknowledge (ACK) or Acknowledge with Data (AWD) message is received for the transmitted data, the ACK\_OUT line is asserted for 100ms. The ACK\_OUT timing restarts on each ACK or AWD packet that is received.

The transceiver sends control messages every 12.5ms as long as any of the status line inputs is high, updating the status line states with each packet. When all input lines are low, the module starts the shutoff sequence.

During the shutoff sequence, the transmitter sends at least one packet with all outputs off. It then continues to transmit data until the current channel hopping cycle is complete, resulting in balanced channel use. If an input line is asserted during the shutoff sequence, the transmitter cancels the shutoff and extends the transmission sequence.

## Receive Operation

During Receive Operation, the module waits for a valid control message from an authorized (paired) transceiver. When a valid message is received, it locks onto the hopping pattern of the transmitter and asserts the MODE\_IND line. It compares the received status line states to the Permission Mask for the IU to see if the IU is authorized to activate the lines. The module sets all authorized outputs to match the received states.

Only status line outputs are affected by received control packets. Received commands to change an input line have no effect.

The RU then checks the state of the ACK\_EN line and transmits an acknowledgement packet if it is high. It looks for the next valid packet while maintaining the frequency hopping timing. As long as an RU is receiving valid commands from a paired IU, it will not respond to any other unit.

Once eight consecutive packets are missed, the RU is logically disconnected from the IU and waits for the next valid packet from any IU.

## The Pair Process

The Pair process enables two transceivers to communicate with each other. Each transceiver has a local 32-bit address that is transmitted with every packet. If the address in the received packet is not in the RU's Paired Module List, then the transceiver does not respond. Adding devices to the authorized list is accomplished through the Pair process or by a serial command. Each module can be paired with up to 40 other modules.

The Pair process is initiated by taking the PAIR line high on both units to be associated. Activation can either be a momentary pulse (less than two seconds) or a sustained high input, which can be used to extend the search and successful pairing display. With a momentary activation, the search is terminated after 30 seconds. If Pairing is started with a sustained high input, the search continues as long as the PAIR input is high.

When Pair is activated, the module displays the Pair Search sequence on the MODE\_IND line (Figure 22) and goes into a search mode where it looks for another module that is also in search mode. It alternates between transmit and receive, enabling one unit to find the other and respond.

Once bidirectional communication is established, the two units store each other's addresses in their Paired Module List with full Permissions Mask and display the Pair Found sequence on their MODE\_IND lines. The Pair Found sequence is displayed for at least 3 seconds. If the PAIR input is held high from the beginning of Pairing, the Pair Found display is shown for as long as PAIR is high.

When Pairing is initiated, the module pairs with the first unit it finds that is also in Pair Search. If multiple systems are being Paired in the same area, such as in a production environment, then steps should be taken to ensure that the correct units are paired with each other.

The Pair process can be canceled by taking PAIR high a second time.

If the address table is full when the PAIR line is raised, the Pair Error sequence is displayed on the MODE\_IND line for 10 seconds and neither of the Pairing units will store an address. In this case, the module should either be reset to clear the address table or the serial interface can be used to remove addresses.

If a paired unit is already in the Paired Module List, then no additional entry is added though the existing entry's Permissions Mask may be modified.

## Permissions Mask

The TT Series Transceiver has a Permissions Mask that is used to control which lines an IU is authorized to control. With most systems, if a transmitter is associated with a receiver then it has full control over the receiver. With the Permissions Mask, a transmitter can be granted authority to control only certain receiver outputs. If an IU does not have the authority to activate a certain line, then the RU does not set it.

As an example, a factory worker can be given a fob that only opens the door to the factory floor while the CEO has a fob that can also open the executive offices. The hardware in the fobs is the same, but the permissions masks are set differently for each fob.

The Pair process always sets the Permission Mask to full access. The mask can be changed through the serial interface.

## Acknowledgement

A responding module is able to send an acknowledgement to the transmitting module. This allows the initiating module to know that the responding side received the command.

When the Responding Unit (RU) receives a valid Control Packet, it checks the state of the ACK\_EN line. If it is high the module sends an Acknowledgement Packet.

If the Initiating Unit (IU) receives an Acknowledgement Packet that has the same Address and Status Byte as in the Control Packet it originally sent, then it pulls the ACK\_OUT line high. A continuous stream of Control Packets that triggers a continuous stream of Acknowledgement Packets keeps the ACK\_OUT line high.

Connecting the ACK\_EN line to  $V_{CC}$  causes the RU to transmit Acknowledgement Packets as soon as it receives a valid Control Packet. Alternately this line can be controlled by an external circuit that raises the line when a specific action has taken place. This confirms to the IU that the action took place and not just acknowledges receipt of the signal.

## Mode Indicator

The Mode Indicator line (MODE\_IND) provides feedback about the current state of the module. This line switches at different rates depending on the module's current operation. When an LED is connected to this line it blinks, providing a visual indication to the user. Figure 22 gives the definitions of the MODE\_IND timings.

MODE_IND Timing	
Module Status	Display
Transmit Mode	Solid ON when transmitting packets.
Receive Mode	Solid ON when receiving packets.
Pair Search	ON for 100ms, OFF for 900ms while searching for another unit during the Pair process
Pair Found	ON for 400ms, OFF for 100ms when the transceiver has been Paired with another transceiver. This is displayed for at least 3 seconds.
Pair Error	ON for 100ms, OFF for 100ms when the address table is full and another unit cannot be added.
Remote Pair Error	ON for 100ms, OFF for 100ms, ON for 100ms OFF for 300ms when the remote unit's address table is full and a Pair cannot be completed.
Pair Canceled	ON for 100ms, OFF for 200ms, ON for 100ms when the Pair process is canceled.
Reset Acknowledgement	ON for 600ms, OFF for 100ms, ON for 200ms, OFF for 100ms, ON for 200ms and OFF for 100ms when the reset sequence is recognized.
Extended Pair Completed	Solid ON when the pairing operation is completed and waiting for the PAIR line to go low.

Figure 22: MODE\_IND Timing

## Reset to Factory Default

The transceiver is reset to factory default by taking the Pair line high briefly 4 times, then holding Pair high for more than 3 seconds. Each brief interval must be high 0.1 to 2 seconds and low 0.1 to 2 seconds. (1 second nominal high / low cycle). The sequence helps prevent accidental resets. Once the sequence is recognized the MODE\_IND line blinks the Reset Acknowledgement defined in Figure 22 until the PAIR line goes low. After the input goes low, the configuration is initialized. Factory reset also clears the Paired Module table but does not change the local address.

If the PAIR input timing doesn't match the reset sequence timing, the module reverts to normal operation without a reset or pairing.

## Using the RSSI Line

The module's Received Signal Strength Indicator (RSSI) line outputs a voltage proportional to the incoming signal strength. The RSSI Voltage vs. Input Power graph in the Typical Performance Graphs section shows the relationship between the RSSI voltage and the incoming signal power. This line has a high impedance so an external buffer may be required for some applications.

The RSSI line updates once a second showing either the strength of the packet received within the last second or the current channel measurement. The formula to convert the RSSI voltage to power in dBm is:

$$P_{RX} = (V_{RSSI} / V_{CC}) * 60 - 105$$

**Note:** The RSSI levels and dynamic range vary from part to part. It is also important to remember that the RSSI output indicates the strength of any in-band RF energy and not necessarily just that from the intended transmitter; therefore, it should be used only to qualify the presence and level of a signal. Using RSSI to determine distance or data validity is not recommended.

The RSSI output can be utilized during testing or even as a product feature to assess interference and channel quality by looking at the RSSI level with all intended transmitters shut off.

## Using the LATCH\_EN Line

The LATCH\_EN line sets the outputs to either momentary operation or latched operation. During momentary operation the outputs go high for as long as control messages are received instructing the module to take the lines high. As soon as the control messages stop, the outputs go low.

During latched operation, when a signal is received to make a particular status line high, it will remain high until a separate activation is received to make it go low. The transmission must stop and the module must time out before it will register a second transmission and toggle the outputs.

When the LATCH\_EN line is high, all of the outputs are latched. A serial command is available to configure latching of individual lines.

## Using the Low Power Features

The Power Down ( $\overline{\text{POWER\_DOWN}}$ ) line can be used to completely power down the transceiver module without the need for an external switch. This line allows easy control of the transceiver power state from external components, such as a microcontroller. The module is not functional while in power down mode.

**Warning:** Pulling any of the module inputs high while in Power Down can partially activate the module, increasing current consumption and potentially placing it into an indeterminate state that could lead to unpredictable operation. Pull all inputs low before pulling  $\overline{\text{POWER\_DOWN}}$  low to prevent this issue. Lines that may be hardwired (for example, the  $\overline{\text{ACK\_EN}}$  line) can be connected to the  $\overline{\text{POWER\_DOWN}}$  line so that they are lowered when  $\overline{\text{POWER\_DOWN}}$  is lowered.

## Using the LVL\_ADJ Line

The Level Adjust (LVL\_ADJ) line allows the transceiver's output power to be easily adjusted for range control or lower power consumption. This is done by placing a resistor to ground on LVL\_ADJ to form a voltage divider with an internal 100k $\Omega$  resistor. When the transceiver powers up, the voltage on this line is measured and the output power level is set accordingly. When LVL\_ADJ is connected to  $V_{CC}$  or floating, the output power and current consumption are the highest. When connected to ground, the output power and current are the lowest. The power is digitally controlled in 58 steps providing approximately 0.5dB per step. See the Typical Performance Graphs section (Figure 6) for a graph of the output power vs. LVL\_ADJ resistance.

**Warning:** The LVL\_ADJ line uses a resistor divider to create a voltage that determines the output power. Any additional current sourcing or sinking can change this voltage and result in a different power level. The power level should be checked to confirm that it is set as expected.

Even in designs where attenuation is not anticipated, it is a good idea to place resistor pads connected to LVL\_ADJ and ground so that it can be used if needed. Figure 23 shows the 1% tolerance resistor value that is needed to set each power level and gives the approximate output power for each level. The output power levels are approximate and may vary part-to-part.

Power Level vs. Resistor Value								
Power Level	$P_o$ (dBm)	1% Resistor Value	Power Level	$P_o$ (dBm)	1% Resistor Value	Power Level	$P_o$ (dBm)	1% Resistor value
57	12.2	Open	38	3.4	154k	19	-5.4	44.2k
56	12.1	750k	37	3.1	143k	18	-5.7	41.2k
55	12.1	649k	36	2.7	133k	17	-6.1	37.4k
54	11.8	576k	35	2.1	127k	16	-6.7	34.8k
53	11.8	510k	34	1.6	118k	15	-7.0	32.4k
52	9.5	453k	33	1.1	111k	14	-7.5	29.4k
51	9.7	412k	32	0.8	105k	13	-7.9	26.7k
50	8.9	347k	31	0.3	97.6k	12	-8.3	24.3k
49	8.3	340k	30	-0.1	91k	11	-8.8	22k
48	8.0	316k	29	-0.6	86.6k	10	-9.3	19.6k
47	7.4	287k	28	-0.9	80.6k	9	-9.1	17.4k
46	6.9	267k	27	-1.4	76.8k	8	-9.6	15.4k
45	6.7	243k	26	-1.8	71.5k	7	-10.2	13.3k
44	6.3	226k	25	-2.3	66.5k	6	-10.8	11.3k
43	5.8	210k	24	-2.8	62k	5	-11.5	9.53k
42	5.3	200k	23	-3.2	57.6k	4	-12.2	7.5k
41	4.8	182k	22	-3.7	54.9k	3	-13.0	5.76k
40	4.3	174k	21	-4.3	51k	2	-13.9	4.02k
39	4.0	165k	20	-4.8	47k	1	-14.5	2.32k
						0	-15.7	750

Figure 23: Power Level vs. Resistor Value



## Receiver Duty Cycle

The module can be configured to automatically power on and off while in receive mode. Instead of being powered on all the time looking for transmissions from an IU, the receiver can wake up, look for data and go back to sleep for a configurable amount of time. If it wakes up and receives valid data, then it stays on and goes back to sleep when the data stops. This significantly reduces the amount of current consumed by the receiver. It also increases the time from activating the IU to getting a response from the RU.

The duty cycle is controlled by the Duty Cycle serial command through the Command Data Interface. DCycle sets the number of seconds between receiver turn on points as shown in Figure 24.

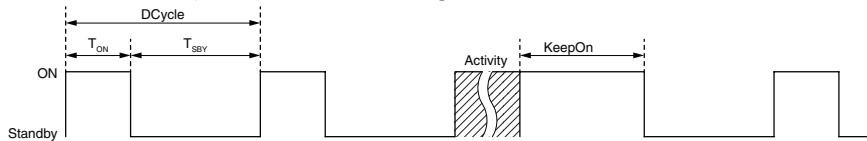

Figure 24: Receiver Duty Cycle

The module's average current consumption can be calculated with the following equation.

$$I_{AVG} = \frac{(T_{ON} \times I_{RX}) + (T_{SBY} \times I_{SBY})}{DCycle}$$

Figure 25: Receiver Duty Cycle Average Current Consumption Equation

$T_{ON}$  is fixed at about 0.326 seconds and  $T_{SBY} = DCycle - T_{ON}$ . The receiver current ( $I_{RX}$ ) and standby current ( $I_{SBY}$ ) vary with supply voltage, but some typical values are in Figure 26.

TT Series Typical Current Consumption								
V <sub>CC</sub> (VDC)	2.5	3.0	3.3	3.5	4.0	4.5	5.0	5.5
I <sub>RX</sub> (mA)	16.5	17.8	18.7	18.8	18.8	18.9	18.9	18.9
I <sub>SBY</sub> (mA)	0.0862	0.1471	0.1509	0.1525	0.1569	0.1616	0.1669	0.1737

Figure 26: TT Series Transceiver Typical Current Consumption

Figure 15 shows a graph of the average current consumption vs. duty cycle for several supply voltages. This graph shows that the average current

consumption can be significantly reduced with even a small duty cycle value. This is ideal for battery-powered applications that need infrequent updates or where response time is not critical.

The KeepOn time is used to keep the receiver on after it has completed some activity. This activity includes completing a transmission and receiving a valid packet. After KeepOn seconds have elapsed with no transmit or valid receive activity, the module goes into standby for DCycle seconds.

Please see Reference Guide RG-00103: the TT Series Command Data Interface for details on configuring the receiver duty cycle.

## Power Supply Requirements

The transceiver incorporates a precision low-dropout regulator which allows operation over a wide input voltage range. Despite this regulator, it is still important to provide a supply that is free of noise. Power supply noise can significantly affect the module's performance, so providing a clean power supply for the module should be a high priority during design.

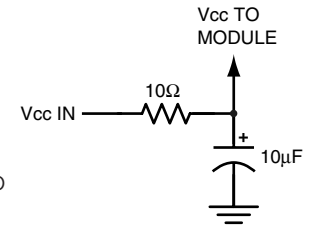

Figure 27: Supply Filter

A 10Ω resistor in series with the supply followed by a 10μF tantalum capacitor from  $V_{CC}$  to ground helps in cases where the quality of supply power is poor (Figure 27). This filter should be placed close to the module's supply lines. These values may need to be adjusted depending on the noise present on the supply line.

## The Command Data Interface

The TT Series transceiver has a serial Command Data Interface (CDI) that offers the option to configure and control the transceiver through software instead of through hardware. This interface consists of a standard UART with a serial command set. This allows for fewer connections in applications controlled by a microcontroller as well as for more control and advanced features than can be offered through hardware pins alone.

The serial port uses the CMD\_DATA\_IN and CMD\_DATA\_OUT lines as a UART. An automatic baud rate detection system allows the interface to run at a variable data rate from 9.6kbps to 57.6kbps.

The Command Data Interface has two sets of operators. One is a set of commands that performs specific tasks and the other is a set of parameters that are for module configuration and status reporting. These are shown in Figure 28.

TT Series Transceiver Command Data Interface Reference Guide has full details on each command. Some key features available with the serial interface are:

- Configure the module through software instead of setting the hardware lines.
- Change the output power, providing the ability to lower power consumption when signal levels are good and extend battery life.
- Individually set which status lines are inputs and outputs.
- Individually set status line outputs to operate as momentary or latched.
- Add or remove specific paired devices.
- Individually set Permission Masks that prevent certain paired devices from activating certain status line outputs.
- Change the module's local address for production or tracking purposes or to replace a lost or broken product.
- Put the module into a low power state to conserve battery power.

- Receive the entire control message serially instead of needing to monitor individual status lines. Get the IU address for logging access attempts.
- Receive control messages from unpaired modules, allowing for expansion of the system beyond the maximum of 40 paired units. Access control and address validation can be undertaken by an external processor or PC with more memory than the module.
- Serially configure and control acknowledge messages.
- Send and receive 2 bytes (16 bits) of custom data with each command message and acknowledge message.
- Serially initiate transmission of control messages instead of triggering the status line inputs.
- Set interrupts to notify an external processor when specific events occur, such as receiving a control message.
- Read out the RSSI value for the last received packet and the current ambient RF level.
- Set the receiver duty cycle for automatically powering on and off to save battery power.

The serial interface offers a great deal of flexibility for use more complicated designs. Please see Reference Guide RG-00103: the TT Series Command Data Interface for details on the CDI. A list of the serial commands is shown in Figure 28 for reference.

Command Data Interface Commands and Parameters	
Command	Description
Read	Read the current value in volatile memory. If there is no volatile value, then the non-volatile value is returned.
Write	Write a new value to volatile memory.
Read NV	Read the value in non-volatile memory.
Program	Program a new value to non-volatile memory.
Set Default Configuration	Set all configuration items to their factory default values.
Erase All Addresses	Erase all paired addresses from memory.
Transmit Control Data	Transmit a control message.
Transmit ACK	Transmit an acknowledgement for received data.
Transmit AWD	Transmit an Acknowledge With Data (AWD) response with two bytes of custom data.
Parameter	Description
Device Name	NULL-terminated string of up to 16 characters that identifies the module. Read only.
Firmware Version	3 byte firmware version. Read only.
Serial Number	4 byte factory-set serial number. Read only.
Local Address	The module's 32-bit local address.
Status Line I/O Mask	Status lines direction (1 = Inputs, 0 = Outputs), LSB = S0, used when enabled by Control Source
Latch Mask	Latching enable for output lines, LSB = S0, used when enabled by Control Source
TX Power Level	TX output power, signed nominal dBm, used when enabled by Control Source
Control Source	Configures the control options.
Message Select	Select message types to capture for serial readout
Paired Module Descriptor	Sets the index number, address and permissions mask of paired modules.
Duty Cycle	Receiver duty cycle control
I/O Lines	Read the current state of the status and control lines.
RSSI	Read the RSSI of the last packet received and ambient level. Read only.
LADJ	Read the voltage on the LVL_ADJ line. Read only.
Module Status	Read the operating status of the module.
Captured Receive Packet	Read the last received packet. Read only.
Interrupt Mask	Sets the mask for events to generate a break on CMD_DATA_OUT.
Event Flags	Event flags that are used with the Interrupt Mask.

Figure 28: TT Series Transceiver Command Data Interface Commands and Parameters

## Frequency Hopping

The module incorporates a Frequency Hopping Spread Spectrum (FHSS) algorithm. This provides immunity from narrow-band interference as well as meets regulatory requirements for higher output power, resulting in longer range.

The module uses 25 RF channels as shown in Figure 29.

Channel Frequencies					
Channel Number	Frequency	Channel Number	Frequency	Channel Number	Frequency
1	902.62	10	907.12	18	911.12
2	903.12	11	907.62	19	911.62
3	903.62	12	908.12	20	912.12
4	904.12	13	908.62	21	912.62
5	904.62	14	909.12	22	913.12
6	905.12	15	909.62	23	913.62
7	905.62	16	910.12	24	914.12
8	906.12	17	910.62	25	914.62
9	906.62				

Figure 29: TT Series Transceiver RF Channel Frequencies

Each channel has a time slot of 12.5ms before the module hops to the next channel. This equal spacing allows a receiver to hop to the next channel at the correct time even if a packet is missed. Up to seven consecutive packets can be missed without losing synchronization.

The hopping pattern is determined from the transmitter's address. Each sequence uses all 25 channels, but in different orders. Once a transmission starts, the module continues through a complete cycle. If the input line is taken low in the middle of a cycle, the module continues transmitting through the end of the cycle to ensure balanced use of all channels.

Frequency hopping has several advantages over single channel operation. Hopping systems are allowed a higher transmitter output power, which results in longer range and better performance within that range. Since the transmission is moving among multiple channels, interference on one channel causes loss on that channel but does not corrupt the entire link. This improves the reliability of the system.

## Usage Guidelines for FCC Compliance

The TT Series module is provided with an FCC and Industry Canada Modular Certification. This certification shows that the module meets the requirements of FCC Part 15 and Industry Canada license-exempt RSS standards for an intentional radiator. The integrator does not need to conduct any further intentional radiator testing under these rules provided that the following guidelines are met:

- An approved antenna must be directly coupled to the module's U.FL connector through an approved coaxial extension cable.
- Alternate antennas can be used, but may require the integrator to perform certification testing.
- The module must not be modified in any way. Coupling of external circuitry must not bypass the provided connectors.
- End product must be externally labeled with "Contains FCC ID: OJMTRM900TTA / IC: 5840A-TRM900TTA".
- The end product's user's manual must contain an FCC statement equivalent to that listed on page 33 of this data guide.
- The antenna used for this transceiver must not be co-located or operating in conjunction with any other antenna or transmitter.
- The integrator must not provide any information to the end-user on how to install or remove the module from the end-product.

**Note:** The integrator is required to perform unintentional radiator testing on the final product per FCC sections 15.107 and 15.109 and IC RSS-GEN.

Any changes or modifications not expressly approved by Linx Technologies could void the user's authority to operate the equipment.

## Additional Testing Requirements

The modules have been tested for compliance as an intentional radiator, but the integrator is required to perform unintentional radiator testing on the final product per FCC sections 15.107 and 15.109 and Industry Canada license-exempt RSS standards. Additional product-specific testing might be required. Please contact the FCC or Industry Canada regarding regulatory requirements for the application. Ultimately it is the integrator's responsibility to show that their product complies with the regulations applicable to their product.

## Information to the user

The following information must be included in the product's user manual.

### FCC / IC NOTICES

This product contains FCC ID: OJMTRM900TTA / IC: 5840A-TRM900TTA

This device complies with Part 15 of the FCC rules and Industry Canada license-exempt RSS standards. Operation of this device is subject to the following two conditions:

1. This device may not cause harmful interference, and
2. this device must accept any interference received, including interference that may cause undesired operation.

This equipment has been tested and found to comply with the limits for a Class B digital device, pursuant to Part 15 of the FCC Rules. These limits are designed to provide reasonable protection against harmful interference in a residential installation. This equipment generates, uses and can radiate radio frequency energy and, if not installed and used in accordance with the instructions, may cause harmful interference to radio communications. However, there is no guarantee that interference will not occur in a particular installation. If this equipment does cause harmful interference to radio or television reception, which can be determined by turning the equipment off and on, the user is encouraged to try to correct the interference by one or more of the following measures:

- Reorient or relocate the receiving antenna.
- Increase the separation between the equipment and receiver.
- Connect the equipment into an outlet on a circuit different from that to which the receiver is connected.
- Consult the dealer or an experienced radio/TV technician for help.

Any modifications could void the user's authority to operate the equipment.

Le présent appareil est conforme aux CNR d'Industrie Canada applicables aux appareils radio exempts de licence. L'exploitation est autorisée aux deux conditions suivantes:

1. l'appareil ne doit pas produire de brouillage, et
2. l'utilisateur de l'appareil doit accepter tout brouillage radioélectrique subi, même si le brouillage est susceptible d'en compromettre le fonctionnement.

## Product Labeling

The end product must be labeled to meet the FCC and IC product label requirements. It must have the below or similar text:

Contains FCC ID: OJMTRM900TTA / IC: 5840A-TRM900TTA

The label must be permanently affixed to the product and readily visible to the user. “Permanently affixed” means that the label is etched, engraved, stamped, silkscreened, indelibly printed, or otherwise permanently marked on a permanently attached part of the equipment or on a nameplate of metal, plastic, or other material fastened to the equipment by welding, riveting, or a permanent adhesive. The label must be designed to last the expected lifetime of the equipment in the environment in which the equipment may be operated and must not be readily detachable.

## FCC RF Exposure Statement

To satisfy RF exposure requirements, this device and its antenna must operate with a separation distance of at least 20cm from all persons and must not be co-located or operating in conjunction with any other antenna or transmitter.

## Antenna Selection

Under FCC and Industry Canada regulations, this radio transmitter may only operate using an antenna of a type and maximum (or lesser) gain approved for the transmitter by the FCC and Industry Canada. To reduce potential radio interference to other users, the antenna type and its gain should be so chosen that the equivalent isotropically radiated power (e.i.r.p.) is not more than that necessary for successful communication.

The TRM-900-TT radio transmitter has been approved by the FCC and Industry Canada to operate with the antenna types listed in Figure 30 with the maximum permissible gain and required antenna impedance for each antenna type indicated. Antenna types not included in this list, having a gain greater than the maximum gain indicated for that type, are strictly prohibited for use with this device.

Conformément à la réglementation d’Industrie Canada, le présent émetteur radio peut fonctionner avec une antenne d’un type et d’un gain maximal (ou inférieur) approuvé pour l’émetteur par Industrie Canada. Dans le but de réduire les risques de brouillage radioélectrique à l’intention des autres utilisateurs, il faut choisir le type d’antenne et son gain de sorte que la puissance isotrope rayonnée équivalente (p.i.r.e.) ne dépasse pas l’intensité nécessaire à l’établissement d’une communication satisfaisante.

Le présent émetteur radio (TRM-900-TT) a été approuvé par Industrie Canada pour fonctionner avec les types d’antenne énumérés la Figure 30 et ayant un gain admissible maximal et l’impédance requise pour chaque type d’antenne. Les types d’antenne non inclus dans cette liste, ou dont le gain est supérieur au gain maximal indiqué, sont strictement interdits pour l’exploitation de l’émetteur.

Antennas / Antennes			
Linx Part Number Référence Linx	Type	Gain	Impedance Impédance
<b>Tested Antennas</b>			
ANT-916-CW-QW	¼ Wave Whip	1.8dBi	50Ω
ANT-916-CW-HW	½ Wave Dipole Helical	1.2dBi	50Ω
ANT-916-PW-LP	¼ Wave Whip	2.4dBi	50Ω
ANT-916-SP	Planar	1.4dBi	50Ω
ANT-916-WRT-RPS	½ Wave Dipole Helical	-0.1dBi	50Ω
ANT-916-CHP	¼ Wave Whip	0.5dBi	50Ω
<b>Antennas of the same type and same or lesser gain</b>			
ANT-916-CW-HD	¼ Wave Whip	-0.3dBi	50Ω
ANT-916-PW-QW	¼ Wave Whip	1.8dBi	50Ω
ANT-916-CW-RCL	¼ Wave Whip	-2.0dBi	50Ω
ANT-916-CW-RH	¼ Wave Whip	-1.3dBi	50Ω
ANT-916-CW-HWR-RPS	½ Wave Dipole Helical	1.2dBi	50Ω
ANT-916-PML	½ Wave Dipole Helical	-0.4dBi	50Ω
ANT-916-PW-RA	¼ Wave Whip	0dBi	50Ω
ANT-916-USP	Planar	0.3dBi	50Ω
Cable Assemblies / Assemblages de Câbles			
Linx Part Number Référence Linx	Description		
CSI-RSFB-300-UFFR*	RP-SMA Bulkhead to U.FL with 300mm cable		
CSI-RSFE-300-UFFR*	RP-SMA External Mount Bulkhead to U.FL with 300mm cable		
* Also available in 100mm and 200mm cable length			

Figure 30: TT Series Approved Antennas

## Typical Applications

Figure 31 and Figure 32 show circuits using the TT Series transceiver.

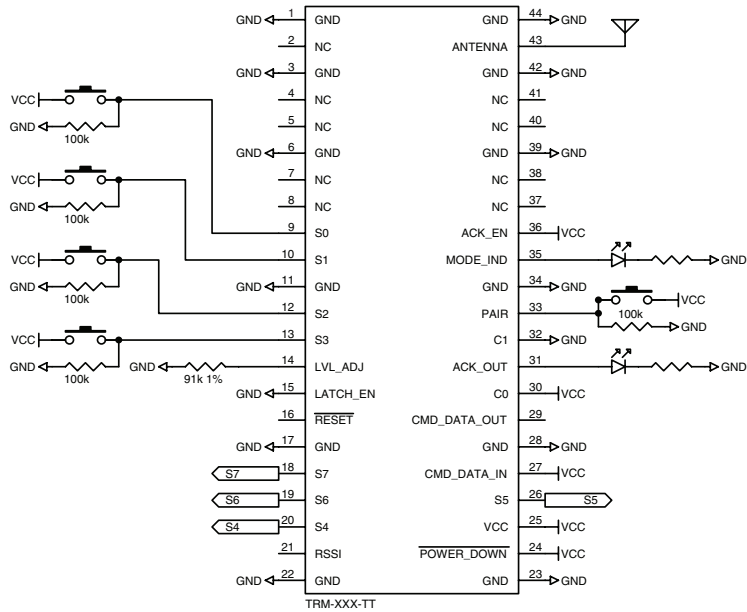

Figure 31: TT Series Transceiver Basic Application Circuit

In this example, C0 is high and C1 is low, so S0–S3 are inputs and S4–S7 are outputs. The inputs are connected to buttons that pull the lines high and weak pull-down resistors to keep the lines from floating when the buttons are not pressed. The outputs would be connected to external application circuitry.

LATCH\_EN is low, so the outputs are momentary.

The Command Data Interface is not used in this design, so CMD\_DATA\_IN is tied high and CMD\_DATA\_OUT is not connected.

ACK\_OUT and MODE\_IND are connected to LEDs to provide visual indication to the user.

PAIR is connected to a button and pull-down resistor to initiate the Pair Process when the button is pressed.

ACK\_EN is tied high so the module sends acknowledgements as soon as it receives a control message.

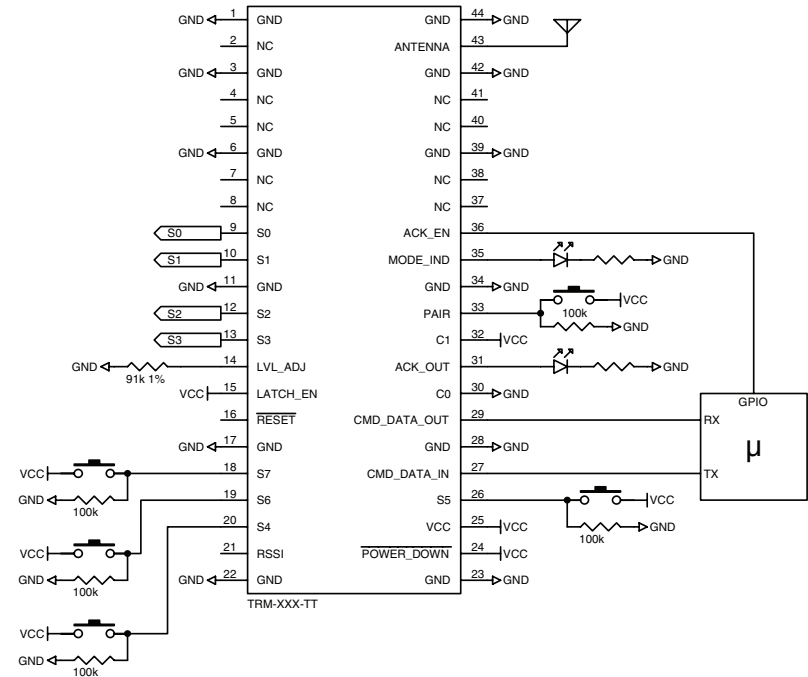

Figure 32: TT Series Transceiver Typical Application Circuit with External Microprocessor

In this example, C0 is low and C1 is high, so S0–S3 are outputs and S4–S7 are inputs. This is inverted from the circuit in Figure 31 making it the matching device.

In this circuit, the Command Data Interface is connected to a microcontroller for using some of the advanced features.

The microcontroller controls the state of the ACK\_EN line. it can receive a command, perform an action and then take the line high to send Acknowledgement packets. This lets the user on the other end know that the action took place and not just that the command was received.

## Antenna Considerations

The choice of antennas is a critical and often overlooked design consideration. The range, performance and legality of an RF link are critically dependent upon the antenna. While adequate antenna performance can often be obtained by trial and error methods, antenna design and matching is a complex



Figure 33: Linx Antennas

task. Professionally designed antennas such as those from Linx (Figure 33) help ensure maximum performance and FCC and other regulatory compliance.

Linx transmitter modules typically have an output power that is higher than the legal limits. This allows the designer to use an inefficient antenna such as a loop trace or helical to meet size, cost or cosmetic requirements and still achieve full legal output power for maximum range. If an efficient antenna is used, then some attenuation of the output power will likely be needed. This can easily be accomplished by using the LVL\_ADJ line.

It is usually best to utilize a basic quarter-wave whip until your prototype product is operating satisfactorily. Other antennas can then be evaluated based on the cost, size and cosmetic requirements of the product. Additional details are in Application Note AN-00500.

The transceiver includes a U.FL connector as well as a line for the antenna connection. This offers the designer a great deal of flexibility in antenna selection and location within the end product. Linx offers cable assemblies with a U.FL connector on one end and several types of standard and FCC-compliant reverse-polarity connectors on the other end. Alternatively, the designer may wish to use the pin and route the antenna to a PCB mount connector or even a printed loop trace antenna. This gives the designer the greatest ability to optimize performance and cost within the design.

**Note:** Either the connector or the line can be used for the antenna, but not both at the same time.

## Helpful Application Notes from Linx

It is not the intention of this manual to address in depth many of the issues that should be considered to ensure that the modules function correctly and deliver the maximum possible performance. We recommend reading the application notes listed in Figure 34 which address in depth key areas of RF design and application of Linx products. These applications notes are available online at [www.linxtechnologies.com](http://www.linxtechnologies.com) or by contacting Linx.

Helpful Application Note Titles	
Note Number	Note Title
AN-00100	RF 101: Information for the RF Challenged
AN-00126	Considerations for Operation Within the 902–928MHz Band
AN-00130	Modulation Techniques for Low-Cost RF Data Links
AN-00140	The FCC Road: Part 15 from Concept to Approval
AN-00500	Antennas: Design, Application, Performance
AN-00501	Understanding Antenna Specifications and Operation
RG-00103	TT Series Transceiver Command Data Interface Reference Guide

Figure 34: Helpful Application Note Titles

## Interference Considerations

The RF spectrum is crowded and the potential for conflict with unwanted sources of RF is very real. While all RF products are at risk from interference, its effects can be minimized by better understanding its characteristics.

Interference may come from internal or external sources. The first step is to eliminate interference from noise sources on the board. This means paying careful attention to layout, grounding, filtering and bypassing in order to eliminate all radiated and conducted interference paths. For many products, this is straightforward; however, products containing components such as switching power supplies, motors, crystals and other potential sources of noise must be approached with care. Comparing your own design with a Linx evaluation board can help to determine if and at what level design-specific interference is present.

External interference can manifest itself in a variety of ways. Low-level interference produces noise and hashing on the output and reduces the link's overall range.

High-level interference is caused by nearby products sharing the same frequency or from near-band high-power devices. It can even come from your own products if more than one transmitter is active in the same area. It is important to remember that only one transmitter at a time can occupy a frequency, regardless of the coding of the transmitted signal. This type of interference is less common than those mentioned previously, but in severe cases it can prevent all useful function of the affected device.

Although technically not interference, multipath is also a factor to be understood. Multipath is a term used to refer to the signal cancellation effects that occur when RF waves arrive at the receiver in different phase relationships. This effect is a particularly significant factor in interior environments where objects provide many different signal reflection paths. Multipath cancellation results in lowered signal levels at the receiver and shorter useful distances for the link.

## Pad Layout

The pad layout diagram in Figure 35 is designed to facilitate both hand and automated assembly.

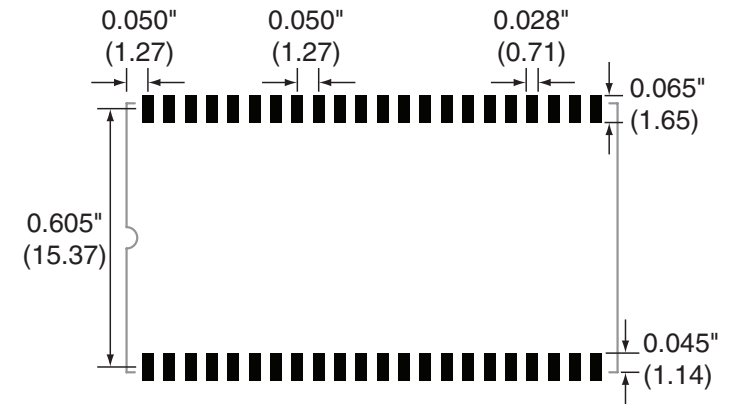

Figure 35: Recommended PCB Layout

## Board Layout Guidelines

The module's design makes integration straightforward; however, it is still critical to exercise care in PCB layout. Failure to observe good layout techniques can result in a significant degradation of the module's performance. A primary layout goal is to maintain a characteristic 50-ohm impedance throughout the path from the antenna to the module. Grounding, filtering, decoupling, routing and PCB stack-up are also important considerations for any RF design. The following section provides some basic design guidelines.

During prototyping, the module should be soldered to a properly laid-out circuit board. The use of prototyping or "perf" boards results in poor performance and is strongly discouraged. Likewise, the use of sockets can have a negative impact on the performance of the module and is discouraged.

The module should, as much as reasonably possible, be isolated from other components on your PCB, especially high-frequency circuitry such as crystal oscillators, switching power supplies, and high-speed bus lines.

When possible, separate RF and digital circuits into different PCB regions.

Make sure internal wiring is routed away from the module and antenna and is secured to prevent displacement.



Do not route PCB traces directly under the module. There should not be any copper or traces under the module on the same layer as the module, just bare PCB. The underside of the module has traces and vias that could short or couple to traces on the product's circuit board.

The Pad Layout section shows a typical PCB footprint for the module. A ground plane (as large and uninterrupted as possible) should be placed on a lower layer of your PC board opposite the module. This plane is essential for creating a low impedance return for ground and consistent stripline performance.

Use care in routing the RF trace between the module and the antenna or connector. Keep the trace as short as possible. Do not pass it under the module or any other component. Do not route the antenna trace on multiple PCB layers as vias add inductance. Vias are acceptable for tying together ground layers and component grounds and should be used in multiples.

Each of the module's ground pins should have short traces tying immediately to the ground plane through a via.

Bypass caps should be low ESR ceramic types and located directly adjacent to the pin they are serving.

A 50-ohm coax should be used for connection to an external antenna. A 50-ohm transmission line, such as a microstrip, stripline or coplanar waveguide should be used for routing RF on the PCB. The Microstrip Details section provides additional information.

In some instances, a designer may wish to encapsulate or "pot" the product. There are a wide variety of potting compounds with varying dielectric properties. Since such compounds can considerably impact RF performance and the ability to rework or service the product, it is the responsibility of the designer to evaluate and qualify the impact and suitability of such materials.

## Microstrip Details

A transmission line is a medium whereby RF energy is transferred from one place to another with minimal loss. This is a critical factor, especially in high-frequency products like Linx RF modules, because the trace leading to the module's antenna can effectively contribute to the length of the antenna, changing its resonant bandwidth. In order to minimize loss and detuning, some form of transmission line between the antenna and the module should be used unless the antenna can be placed very close (<1/8in) to the module. One common form of transmission line is a coax cable and another is the microstrip. This term refers to a PCB trace running over a ground plane that is designed to serve as a transmission line between the module and the antenna. The width is based on the desired characteristic impedance of the line, the thickness of the PCB and the dielectric constant of the board material. For standard 0.062in thick FR-4 board material, the trace width would be 111 mils. The correct trace width can be calculated for other widths and materials using the information in Figure 36 and examples are provided in Figure 37. Software for calculating microstrip lines is also available on the Linx website.

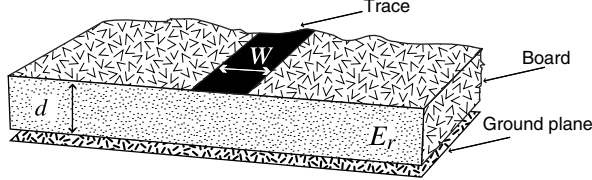

$$E_e = \frac{E_r + 1}{2} + \frac{E_r - 1}{2} \cdot \frac{1}{\sqrt{1 + 12d/W}}$$

$$Z_0 = \begin{cases} \frac{60}{\sqrt{E_e}} \cdot \ln\left(\frac{8d}{W} + \frac{W}{4d}\right) & \text{For } \frac{W}{d} \leq 1 \\ \frac{120\pi}{\sqrt{E_e} \cdot \left(\frac{W}{d} + 1.393 + 0.667 \cdot \ln\left(\frac{W}{d} + 1.444\right)\right)} & \text{For } \frac{W}{d} \geq 1 \end{cases}$$

$E_r$  = Dielectric constant of PCB material

Figure 36: Microstrip Formulas

Example Microstrip Calculations			
Dielectric Constant	Width / Height Ratio (W / d)	Effective Dielectric Constant	Characteristic Impedance (Ω)
4.80	1.8	3.59	50.0
4.00	2.0	3.07	51.0
2.55	3.0	2.12	48.8

Figure 37: Example Microstrip Calculations

## Production Guidelines

The module is housed in a hybrid SMD package that supports hand and automated assembly techniques. Since the modules contain discrete components internally, the assembly procedures are critical to ensuring the reliable function of the modules. The following procedures should be reviewed with and practiced by all assembly personnel.

## Hand Assembly

Pads located on the bottom of the module are the primary mounting surface (Figure 38). Since these pads are inaccessible during mounting, castellations that run up the side of the module have been provided to facilitate solder wicking to the module's underside. This allows for very

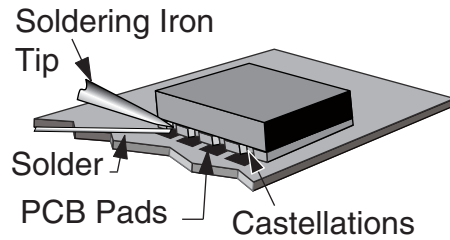

Figure 38: Soldering Technique

quick hand soldering for prototyping and small volume production. If the recommended pad guidelines have been followed, the pads will protrude slightly past the edge of the module. Use a fine soldering tip to heat the board pad and the castellation, then introduce solder to the pad at the module's edge. The solder will wick underneath the module, providing reliable attachment. Tack one module corner first and then work around the device, taking care not to exceed the times in Figure 39.

**Warning:** Pay attention to the absolute maximum solder times.

### Absolute Maximum Solder Times

Hand Solder Temperature: +427°C for 10 seconds for lead-free alloys

Reflow Oven: +255°C max (see Figure 40)

Figure 39: Absolute Maximum Solder Times

## Automated Assembly

For high-volume assembly, the modules are generally auto-placed. The modules have been designed to maintain compatibility with reflow processing techniques; however, due to their hybrid nature, certain aspects of the assembly process are far more critical than for other component types. Following are brief discussions of the three primary areas where caution must be observed.

## Reflow Temperature Profile

The single most critical stage in the automated assembly process is the reflow stage. The reflow profile in Figure 40 should not be exceeded because excessive temperatures or transport times during reflow will irreparably damage the modules. Assembly personnel need to pay careful attention to the oven's profile to ensure that it meets the requirements necessary to successfully reflow all components while still remaining within the limits mandated by the modules. The figure below shows the recommended reflow oven profile for the modules.

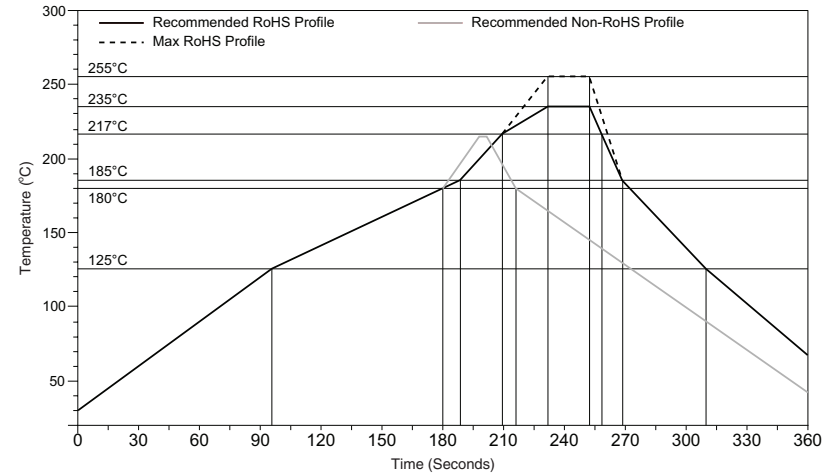

Figure 40: Maximum Reflow Temperature Profile

## Shock During Reflow Transport

Since some internal module components may reflow along with the components placed on the board being assembled, it is imperative that the modules not be subjected to shock or vibration during the time solder is liquid. Should a shock be applied, some internal components could be lifted from their pads, causing the module to not function properly.

## Washability

The modules are wash-resistant, but are not hermetically sealed. Linx recommends wash-free manufacturing; however, the modules can be subjected to a wash cycle provided that a drying time is allowed prior to applying electrical power to the modules. The drying time should be sufficient to allow any moisture that may have migrated into the module to evaporate, thus eliminating the potential for shorting damage during power-up or testing. If the wash contains contaminants, the performance may be adversely affected, even after drying.