



Chipsmall Limited consists of a professional team with an average of over 10 year of expertise in the distribution of electronic components. Based in Hongkong, we have already established firm and mutual-benefit business relationships with customers from,Europe,America and south Asia,supplying obsolete and hard-to-find components to meet their specific needs.

With the principle of “Quality Parts,Customers Priority,Honest Operation,and Considerate Service”,our business mainly focus on the distribution of electronic components. Line cards we deal with include Microchip,ALPS,ROHM,Xilinx,Pulse,ON,Everlight and Freescale. Main products comprise IC,Modules,Potentiometer,IC Socket,Relay,Connector.Our parts cover such applications as commercial,industrial, and automotives areas.

We are looking forward to setting up business relationship with you and hope to provide you with the best service and solution. Let us make a better world for our industry!



Contact us

Tel: +86-755-8981 8866 Fax: +86-755-8427 6832

Email & Skype: info@chipsmall.com Web: www.chipsmall.com

Address: A1208, Overseas Decoration Building, #122 Zhenhua RD., Futian, Shenzhen, China



TS1107/10 Data Sheet

Electronic Circuit Breaker: High Side Current Sense Amplifier with Current Limiter Comparator and FET Control (TS1110 only)

The TS1110 Electronic Circuit Breaker uses a bidirectional current-sense amplifier for current limit detection to disconnect the load by use of an external P-channel MOSFET. An internal Current Limit Comparator with an adjustable threshold provides a latch capable output to signal when a fault condition has occurred. Once the Current Limit Comparator's output is latched the internal FET control is enabled which drives the gate of the external P-channel MOSFET, disconnecting the load from the power supply. Once the fault condition is removed, the system may be reset by strobing or pulling the latch enable pin, CLATCH, low. The Circuit Breaker system delay of the TS1110 is typically 428 μ s. The Current Limiter system delay of the TS1107 and TS1110 is typically 670 μ s.

Applications

- Power Management Systems
- Portable/Battery-Powered Systems
- Smart Chargers
- Battery Monitoring
- Overcurrent and Undercurrent Detection
- Remote Sensing
- Industrial Controls

KEY FEATURES

- Circuit Breaker with Latching Load Disconnect
- Internal Latching Current Limiter Comparator with CLATCH Reset
- Programmable Current Limit
- COUT Output Signals Fault Condition
- Low Supply Current
 - Current Sense Amplifier: 0.68 μ A
 - TS1110 I_{VDD} : 1.16 μ A
 - TS1107 I_{VDD} : 1.15 μ A
- High Side Bidirectional Current Sense Amplifier
- Wide CSA Input Common Mode Range: +2 V to +27 V
- Low CSA Input Offset Voltage: 150 μ V(max)
- Low Gain Error: 1% (max)
- Two Gain Options Available for TS1107 and TS1110:
 - Gain = 20 V/V : TS1107-20 and TS1110-20
 - Gain = 200 V/V : TS1107-200 and TS1110-200
- 16-Pin TQFN Packaging (3 mm x 3 mm)

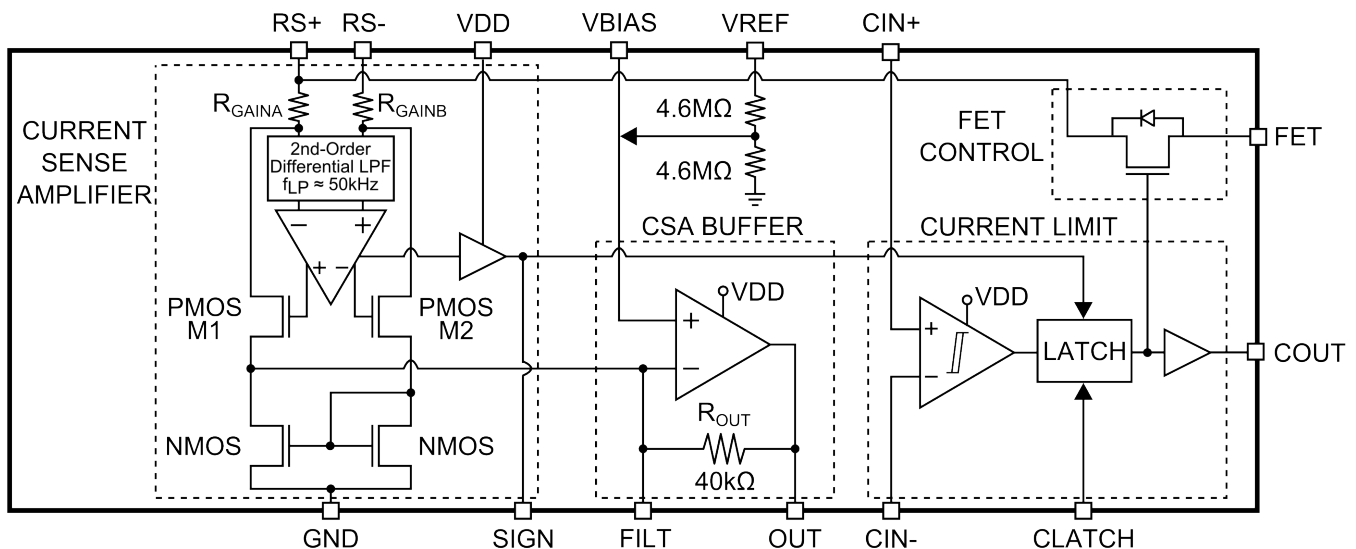

1. Ordering Information

Table 1.1. Ordering Part Numbers

Ordering Part Number	Description	FET Control	Gain V/V
TS1107-20ITQ1633	Electronic Circuit Breaker: High Side Current Sense Amplifier with Current Limiter Comparator	No	20
TS1107-200ITQ1633	Electronic Circuit Breaker: High Side Current Sense Amplifier with Current Limiter Comparator	No	200
TS1110-20ITQ1633	Electronic Circuit Breaker: High Side Current Sense Amplifier with Current Limiter Comparator and FET Control	Yes	20
TS1110-200ITQ1633	Electronic Circuit Breaker: High Side Current Sense Amplifier with Current Limiter Comparator and FET Control	Yes	200

Note: Adding the suffix “T” to the part number (e.g. TS1107-200ITQ1633T) denotes tape and reel.

2. System Overview

2.1 Functional Block Diagrams

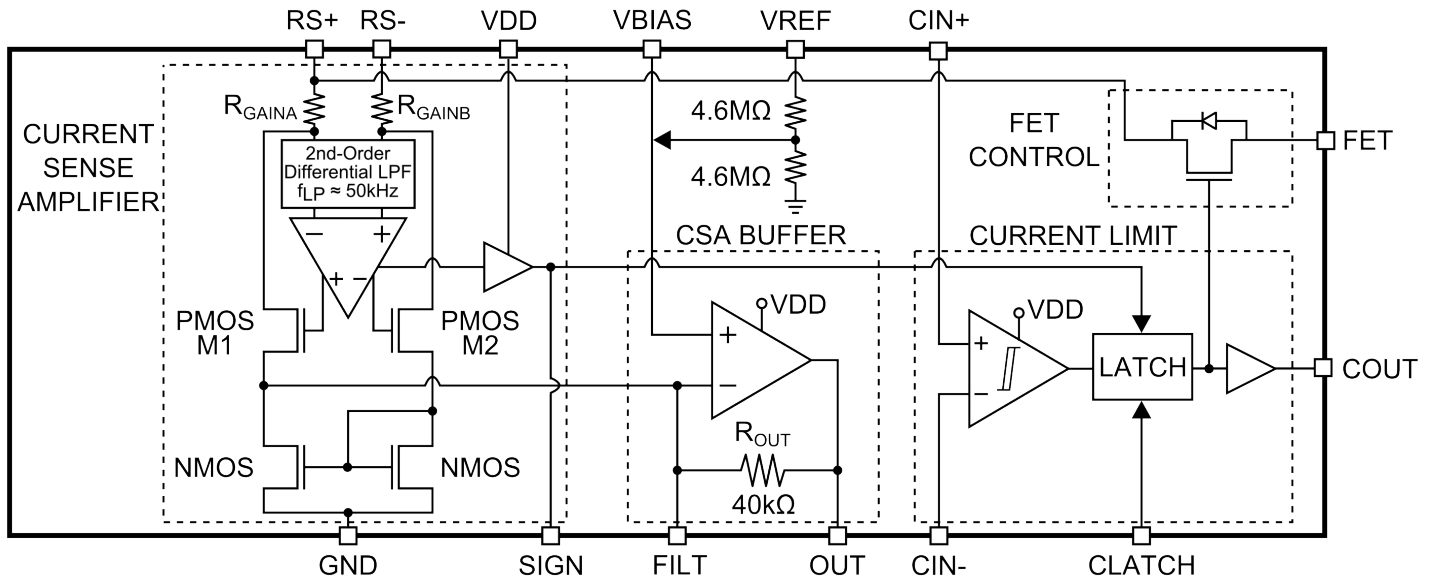

Figure 2.1. TS1110 Current Limit with FET Control Block Diagram

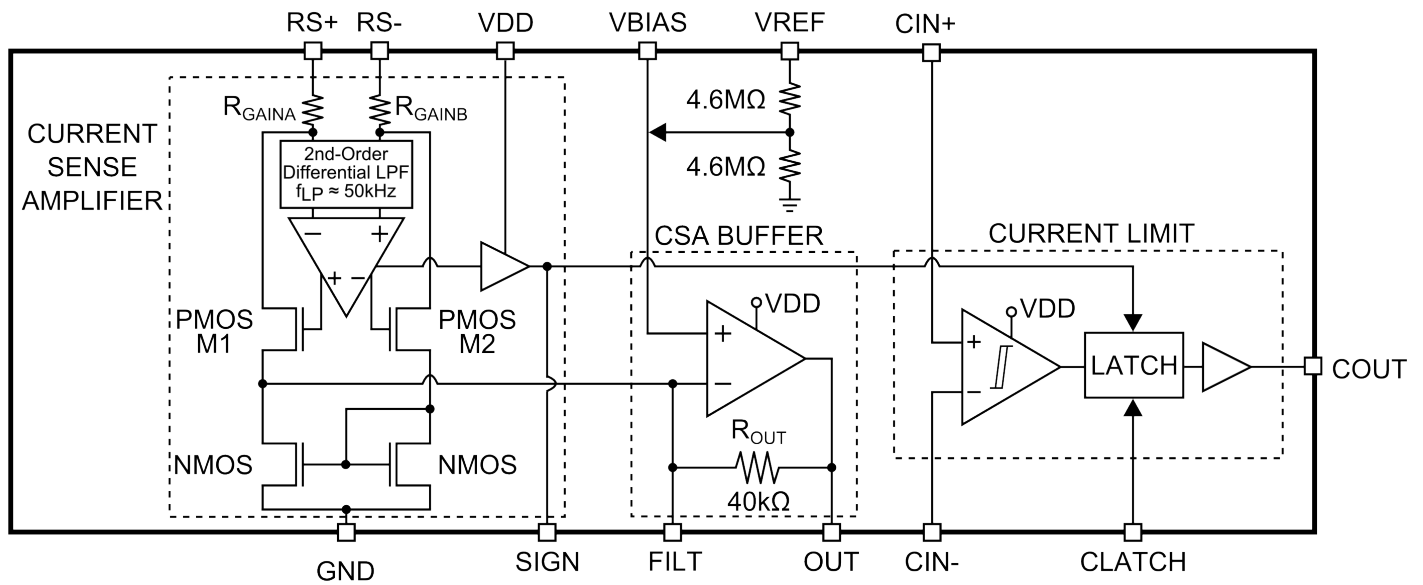

Figure 2.2. TS1107 Current Limit Block Diagram

2.2 Current Sense Amplifier + Output Buffer

The internal configuration of the TS1107/10 bidirectional current-sense amplifier is a variation of the TS1101 bidirectional current-sense amplifier. The TS1107/10 current-sense amplifier is configured for fully differential input/output operation.

Referring to the block diagram, the inputs of the TS1107/10's differential input/output amplifier are connected to RS+ and RS– across an external R_{SENSE} resistor that is used to measure current. At the non-inverting input of the current-sense amplifier, the applied voltage difference in voltage between RS+ and RS– is I_{LOAD} × R_{SENSE}. Since the RS– terminal is the non-inverting input of the internal op-amp, the current-sense op-amp action drives PMOS[1/2] to drive current across R_{GAIN[A/B]} to equalize voltage at its inputs.

Thus, since the M1 PMOS source is connected to the inverting input of the internal op-amp and since the voltage drop across R_{GAINA} is the same as the external V_{SENSE}, the M1 PMOS drain-source current is equal to:

$$I_{DS(M1)} = \frac{V_{SENSE}}{R_{GAINA}}$$

or

$$I_{DS(M1)} = \frac{I_{LOAD} \times R_{SENSE}}{R_{GAINA}}$$

The drain terminal of the M1 PMOS is connected to the transimpedance amplifier's gain resistor, R_{OUT}, via the inverting terminal. The non-inverting terminal of the transimpedance amplifier is internally connected to V_{BIAS}, therefore the output voltage of the TS1107/10 at the OUT terminal is:

$$V_{OUT} = V_{BIAS} - I_{LOAD} \times R_{SENSE} \times \frac{R_{OUT}}{R_{GAINA}}$$

When the voltage at the RS– terminal is greater than the voltage at the RS+ terminal, the external V_{SENSE} voltage drop is impressed upon R_{GAINB}. The voltage drop across R_{GAINB} is then converted into a current by the M2 PMOS. The M2 PMOS drain-source current is the input current for the NMOS current mirror which is matched with a 1-to-1 ratio. The transimpedance amplifier sources the M2 PMOS drain-source current for the NMOS current mirror. Therefore the output voltage of the TS1107/10 at the OUT terminal is:

$$V_{OUT} = V_{BIAS} + I_{LOAD} \times R_{SENSE} \times \frac{R_{OUT}}{R_{GAINB}}$$

When M1 is conducting current (V_{RS+} > V_{RS–}), the TS1107/10's internal amplifier holds M2 OFF. When M2 is conducting current (V_{RS–} > V_{RS+}), the internal amplifier holds M1 OFF. In either case, the disabled PMOS does not contribute to the resultant output voltage.

The current-sense amplifier's gain accuracy is therefore the ratio match of R_{OUT} to R_{GAIN[A/B]}. For each of the gain options available, The following table lists the values for R_{GAIN[A/B]}.

Table 2.1. Internal Gain Setting Resistors (Typical Values)

GAIN (V/V)	R _{GAIN[A/B]} (Ω)	R _{OUT} (Ω)	Part Number
20	2 k	40 k	TS1110-20
200	200	40 k	TS1110-200
20	2 k	40 k	TS1107-20
200	200	40 k	TS1107-200

The TS1107/10 allows access to the inverting terminal of the transimpedance amplifier by the FILT pin, whereby a series RC filter may be connected to reduce noise at the OUT terminal. The recommended RC filter is 4 kΩ and 0.47 μF connected in series from FILT to GND to suppress the noise. Any capacitance at the OUT terminal should be minimized for stable operation of the buffer.

2.3 Sign Output

The TS1107/10 SIGN output indicates the load current's direction. The SIGN output is a logic HIGH when M1 is conducting current ($V_{RS+} > V_{RS-}$). Alternatively, the SIGN output is a logic LOW when M2 is conducting current ($V_{RS-} > V_{RS+}$). The SIGN comparator's transfer characteristic is illustrated in Figure 1. Unlike other current-sense amplifiers that implement an OUT/SIGN arrangement, the TS1107/10 exhibits no "dead zone" at ILOAD switchover.

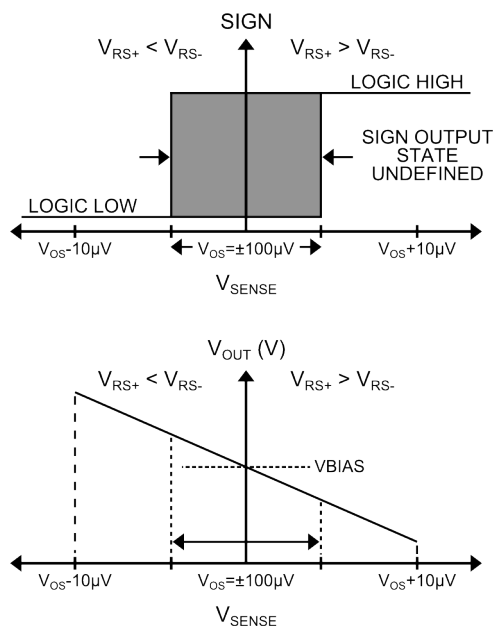

Figure 2.3. TS1107/10 Sign Output Transfer Characteristic

2.4 Current Limit Comparator

The TS1107/10 provides a comparator which can be used for current limit detection. The current limit threshold can be set to detect either positive or negative current, though it provides fastest response in the positive direction. In a typical configuration, the inverting terminal, CIN- is connected to OUT. The non-inverting terminal of the comparator, CIN+, should be supplied with an external voltage or a resistor divider from the supply voltage, which is used as the threshold voltage for the current limiter. The output of the comparator is latch capable only when the Sign Comparator is HIGH ($V_{RS+} > V_{RS-}$), and CLATCH is held HIGH. Once the comparator output (COUT) is triggered, COUT will latch HIGH and maintain the HIGH state as long as CLATCH is held HIGH. To reset COUT to the default comparator output state, CLATCH must be held or strobed LOW.

2.5 FET Control (TS1110 Only)

A "circuit breaker" feature is supplied within the TS1110 as a FET control which drives the gate drive of an external P-channel MOS-FET. When the Current Limit Comparator's output goes HIGH and the LATCH feature is enabled, the FET control output will latch HIGH thereby disconnecting current flow to the load by holding the gate of the external PMOS HIGH. To resume current flow to the load, the FET control must be brought low by holding or strobing CLATCH low. The output of the comparator controls the gate logic of an internal FET whereby the source is connected to the non-inverting terminal of the CSA, RS+, while the drain is fed to the FET pin. The FET pin is intended to drive the gate of an external PMOS, where the PMOS source is connected to the inverting terminal of the CSA, RS-, and the drain is connected to the external load. FET will maintain its logic LOW state while the comparator output, COUT, is LOW. When COUT is latched HIGH, the FET pin will latch to a HIGH state, thereby switching and holding the external PMOS OFF. The FET control features a Turn ON Time, $t_{FET(ON)}$, of 720 ns(typ) and a Turn OFF Time, $t_{FET(OFF)}$, of 2.9 ms(typ) when driving a 860 pF gate capacitance. Note that the FET Control is a pull-up only. A pull-down resistor is required from the external FET's gate to ground to ensure the FET is normally ON.

2.6 VREF Divider

The TS1107/10 provides an internal voltage divider network to set VBIAS, eliminating the need for externally setting the voltage. The VREF Divider is activated once the voltage applied to VREF is 0.9 V or greater. The VREF divider connects to VBIAS, where the VBIAS voltage is equal to 50% of VREF. The VREF Divider exhibits a total series resistance of 9.2 MΩ from VREF to GND.

2.7 Selecting a Sense Resistor

Selecting the optimal value for the external R_{SENSE} is based on the following criteria and for each commentary follows:

1. R_{SENSE} Voltage Loss
2. V_{OUT} Swing vs. Desired V_{SENSE} and Applied Supply Voltage at VDD
3. Total I_{LOAD} Accuracy
4. Circuit Efficiency and Power Dissipation
5. R_{SENSE} Kelvin Connections

2.7.1 RSENSE Voltage Loss

For lowest IR power dissipation in R_{SENSE} , the smallest usable resistor value for R_{SENSE} should be selected.

2.7.2 VOUT Swing vs. Desired VSENSE and Applied Supply Voltage at VDD

Although the Current Sense Amplifier draws its power from the voltage at its $RS+$ and $RS-$ terminals, the signal voltage at the OUT terminal is provided by a buffer, and is therefore bounded by the buffer's output range. As shown in the Electrical Characteristics table, the CSA Buffer has a maximum and minimum output voltage of:

$$V_{OUT(max)} = VDD_{(min)} - 0.2V$$

$$V_{OUT(min)} = 0.2V$$

Therefore, the full-scale sense voltage should be chosen so that the OUT voltage is neither greater nor less than the maximum and minimum output voltage defined above. To satisfy this requirement, the positive full-scale sense voltage, $V_{SENSE(pos_max)}$, should be chosen so that:

$$V_{SENSE(pos_max)} < \frac{VBIAS - V_{OUT(min)}}{GAIN}$$

The negative full-scale sense voltage, $V_{SENSE(neg_min)}$, should be chosen so that:

$$V_{SENSE(neg_min)} < \frac{V_{OUT(max)} - VBIAS}{GAIN}$$

For best performance, R_{SENSE} should be chosen so that the full-scale V_{SENSE} is less than ± 75 mV.

2.7.3 Total Load Current Accuracy

In the TS1107/10's linear region where $V_{OUT(min)} < V_{OUT} < V_{OUT(max)}$, there are two specifications related to the circuit's accuracy: a) the TS1107/10 CSA's input offset voltage ($V_{OS(max)} = 150 \mu V$), b) the TS1107/10 CSA's gain error ($GE_{(max)} = 1\%$). An expression for the TS110's total error is given by:

$$V_{OUT} = VBIAS - [GAIN \times (1 \pm GE) \times V_{SENSE}] \pm (GAIN \times V_{OS})$$

A large value for R_{SENSE} permits the use of smaller load currents to be measured more accurately because the effects of offset voltages are less significant when compared to larger V_{SENSE} voltages. Due care though should be exercised as previously mentioned with large values of R_{SENSE} .

2.7.4 Circuit Efficiency and Power Dissipation

IR losses in R_{SENSE} can be large especially at high load currents. It is important to select the smallest, usable R_{SENSE} value to minimize power dissipation and to keep the physical size of R_{SENSE} small. If the external R_{SENSE} is allowed to dissipate significant power, then its inherent temperature coefficient may alter its design center value, thereby reducing load current measurement accuracy. Precisely because the TS1107/10 CSA's input stage was designed to exhibit a very low input offset voltage, small R_{SENSE} values can be used to reduce power dissipation and minimize local hot spots on the pcb.

2.7.5 RSENSE Kelvin Connections

For optimal V_{SENSE} accuracy in the presence of large load currents, parasitic pcb track resistance should be minimized. Kelvin-sense pcb connections between R_{SENSE} and the TS1107/10's $RS+$ and $RS-$ terminals are strongly recommended. The drawing below illustrates the connections between the current-sense amplifier and the current-sense resistor. The pcb layout should be balanced and symmetrical to minimize wiring-induced errors. In addition, the pcb layout for R_{SENSE} should include good thermal management techniques for optimal R_{SENSE} power dissipation.

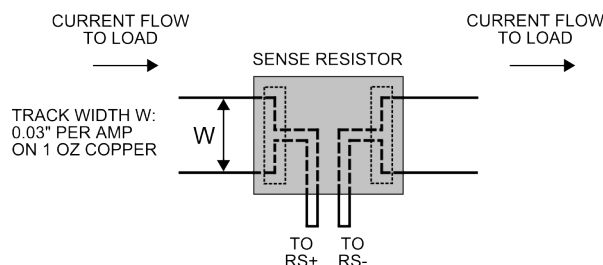

Figure 2.4. Making PCB Connections to R_{SENSE}

2.7.6 RSENSE Composition

Current-shunt resistors are available in metal film, metal strip, and wire-wound constructions. Wire-wound current-shunt resistors are constructed with wire spirally wound onto a core. As a result, these types of current shunt resistors exhibit the largest self-inductance. In applications where the load current contains high-frequency transients, metal film or metal strip current sense resistors are recommended.

2.7.7 Internal Noise Filter

In power management and motor control applications, current-sense amplifiers are required to measure load currents accurately in the presence of both externally-generated differential and common-mode noise. An example of differential-mode noise that can appear at the inputs of a current-sense amplifier is high-frequency ripple. High-frequency ripple (whether injected into the circuit inductively or capacitively) can produce a differential-mode voltage drop across the external current-shunt resistor, R_{SENSE} . An example of externally-generated, common-mode noise is the high-frequency output ripple of a switching regulator that can result in common-mode noise injection into both inputs of a current-sense amplifier.

Even though the load current signal bandwidth is dc, the input stage of any current-sense amplifier can rectify unwanted, out-of-band noise that can result in an apparent error voltage at its output. Against common-mode injection noise, the current-sense amplifier's internal common-mode rejection ratio is 130 dB (typ).

To counter the effects of externally-injected noise, the TS1107/10 incorporates a 50 kHz (typ), 2nd-order differential low-pass filter as shown in the TS1107/10's block diagram, thereby eliminating the need for an external low-pass filter which can generate errors in the offset voltage and the gain error.

2.7.8 PC Board Layout and Power-Supply Bypassing

For optimal circuit performance, the TS1107/10 should be in very close proximity to the external current-sense resistor and the pcb tracks from R_{SENSE} to the $RS+$ and the $RS-$ input terminals of the TS1107/10 should be short and symmetric. Also recommended are surface mount resistors and capacitors, as well as a ground plane.

3. Electrical Characteristics

Table 3.1. Recommended Operating Conditions¹

Parameter	Symbol	Conditions	Min	Typ	Max	Units
System Specifications						
Operating Voltage Range	VDD		1.7	—	5.25	V
Common-Mode Input Range	V _{CM}	V _{RS+} , Guaranteed by CMRR	2	—	27	V
Note:						
1. All devices 100% production tested at T _A = +25 °C. Limits over Temperature are guaranteed by design and characterization.						

Table 3.2. DC Characteristics¹

Parameter	Symbol	Conditions	Min	Typ	Max	Units	
System Specifications							
No Load Input Supply Current	I _{RS+} + I _{RS-}	See Note 2	—	0.68	1.2	μA	
	I _{VDD}	See Note 2	TS1107	—	1.15	1.84	μA
			TS1110	—	1.16	1.85	μA
Current Sense Amplifier							
Common Mode Rejection Ratio	CMRR	2 V < V _{RS+} < 27 V	120	130	—	dB	
Input Offset Voltage ³	V _{OS}	T _A = +25 °C	—	±100	±150	μV	
		−40 °C < T _A < +85 °C	—	—	±200	μV	
V _{OS} Hysteresis ⁴	V _{HYS}	T _A = +25 °C	—	10	—	μV	
Gain	G	TS1107-20, TS1110-20	—	20	—	V/V	
		TS1107-200, TS1110-200	—	200	—	V/V	
Positive Gain Error ⁵	GE+	T _A = +25 °C	—	±0.1	±0.6	%	
		−40 °C < T _A < +85 °C	—	—	±1	%	
Negative Gain Error ⁵	GE−	T _A = +25 °C	—	±0.6	±1	%	
		−40 °C < T _A < +85 °C	—	—	±1.4	%	
Gain Match ⁵	GM	T _A = +25 °C	—	±0.6	±1	%	
		−40 °C < T _A < +85 °C	—	—	±1.4	%	
Transfer Resistance	R _{OUT}	From FILT to OUT	28	40	52.8	kΩ	
CSA Buffer							
Input Bias Current	I _{Buffer_BIAS}	−40 °C < T _A < +85 °C	—	0.3	—	nA	
Input referred DC Offset	V _{Buffer_OS}		—	—	±2.5	mV	
Offset Drift	TCV _{Buffer_OS}	−40 °C < T _A < +85 °C	—	0.6	—	μV/°C	
Input Common Mode Range	V _{Buffer_CM}	−40 °C < T _A < +85 °C	0.2	—	VDD − 0.2	V	

Parameter	Symbol	Conditions	Min	Typ	Max	Units
Output Range	$V_{OUT(min,max)}$	$I_{OUT} = \pm 150 \mu A$	0.2	—	$V_{DD} - 0.2$	V
Sign Comparator Parameters						
Output Low Voltage	V_{SIGN_OL}	$V_{DD} = 1.8 V, I_{SINK} = 35 \mu A$	—	—	0.2	V
Output High Voltage	V_{SIGN_OH}	$V_{DD} = 1.8 V, I_{SOURCE} = 35 \mu A$	$V_{DD} - 0.2$	—	—	V
Comparator						
Input Bias Current	I_{CIN_BIAS}	CIN-	—	0.3	—	nA
Input Bias Current	I_{CIN+_BIAS}	CIN+	—	0.3	—	nA
Input referred DC offset	V_{C_OS}	$-40^\circ C < T_A < +85^\circ C$	—	—	± 4	mV
Input Common Mode Range	V_{C_CM}		0.4	—	V_{DD}	V
COOUT Output Range	$V_{COOUT(min,max)}$	$I_{COOUT} = \pm 500 \mu A; V_{DD} = 1.7 V$	0.4	—	$V_{DD} - 0.4$	V
CLATCH Input Voltage	CLATCH _{Lo}	Low CMOS Logic Level	—	—	0.4	V
	CLATCH _{Hi}	High CMOS Logic Level	$V_{DD} - 0.4$	—	—	V
FET Control (TS1110 Only)						
FET Leakage	$I_{FET_Leakage}$	$T_A = +25^\circ C$	—	—	4.5	nA
FET Sourcing Current	$I_{FET_Source(max)}$	$T_A = +25^\circ C$	—	3.2	17.4	mA
FET Internal On Resistance	R_{FET_ON}	$T_A = +25^\circ C$	—	487	794	Ω
VREF Divider						
VREF Activation voltage	$V_{REF(min)}$	VREF Rising edge	—	—	0.9	V
Resistor on VREF	R_{VREF}		—	9.2	—	M Ω
VBIAS	V_{VBIAS}	$V_{REF} = 1 V$	0.495	0.5	0.505	V
Note:						
1. $RS+ = RS- = 3.6 V$; $V_{SENSE} = (V_{RS+} - V_{RS-}) = 0 V$; $V_{DD} = 3 V$; $V_{BIAS} = 1.5 V$; $CIN+ = 0.75 V$; $V_{REF} = GND$; $CLATCH = GND$; $R_{FET} = 1 M\Omega$; $FILT$ connected to $4 k\Omega$ and $470 nF$ in series to GND . $T_A = T_J = -40^\circ C$ to $+85^\circ C$ unless otherwise noted. Typical values are at $T_A = +25^\circ C$.						
2. Extrapolated to $V_{OUT} = V_{FILT}$; $I_{RS+} + I_{RS-}$ is the total current into the $RS+$ and the $RS-$ pins.						
3. Input offset voltage V_{OS} is extrapolated from a $V_{OUT(+)}$ measurement with V_{SENSE} set to $+1 mV$ and a $V_{OUT(-)}$ measurement with V_{SENSE} set to $-1 mV$; average $V_{OS} = (V_{OUT(-)} - V_{OUT(+)}) / (2 \times GAIN)$.						
4. Amplitude of V_{SENSE} lower or higher than V_{OS} required to cause the comparator to switch output states.						
5. Gain error is calculated by applying two values for V_{SENSE} and then calculating the error of the actual slope vs. the ideal transfer characteristic. For $GAIN = 20 V/V$, the applied V_{SENSE} for $GE\pm$ is $\pm 25 mV$ and $\pm 60 mV$. For $GAIN = 200 V/V$, the applied V_{SENSE} for $GE\pm$ is $\pm 2.5 mV$ and $\pm 6 mV$.						

Table 3.3. AC Characteristics¹

Parameter	Symbol	Conditions	Min	Typ	Max	Units	
CSA Buffer							
Output Settling time	t_{OUT_s}	1% Final value, $V_{OUT} = 1.3\text{ V}$	Gain = 20 V/V	—	1.35	—	msec
Sign Comparator							
Propagation Delay	t_{SIGN_PD}	$V_{SENSE} = \pm 1\text{ mV}$		—	3	—	msec
		$V_{SENSE} = \pm 10\text{ mV}$		—	0.4	—	msec
Comparator							
Rising Propagation Delay	t_{C_PDR}	Overdrive = 10 mV, $C_{COUT} = 15\text{ pF}$		—	9	—	μs
Comparator Hysteresis	V_{C_HYS}	CIN– falling		—	20	—	mV
FET Control (TS1110 Only)							
FET Turn ON Time	$T_{FET(ON)}$	See Note 2		—	0.255	—	μs
Note:							
1. $RS+ = RS- = 3.6\text{ V}$, $V_{SENSE} = (V_{RS+} - V_{RS-}) = 0\text{ V}$, $VDD = 3\text{ V}$, $VBIAS = 1.5\text{ V}$. $T_A = T_J = -40\text{ }^\circ\text{C}$ to $+85\text{ }^\circ\text{C}$ unless otherwise noted. Typical values are at $T_A = +25\text{ }^\circ\text{C}$.							
2. Delay after comparator is triggered. Refer to FET ON Time vs. Gate Capacitance graph.							

Table 3.4. Thermal Conditions

Parameter	Symbol	Conditions	Min	Typ	Max	Units
Operating Temperature Range	T_{OP}		–40	—	+85	$^\circ\text{C}$

Table 3.5. Absolute Maximum Limits

Parameter	Symbol	Conditions	Min	Typ	Max	Units
RS+ Voltage	V_{RS+}		-0.3	—	27	V
RS- Voltage	V_{RS-}		-0.3	—	27	V
FET Voltage (TS1110 Only)	V_{FET}		-0.3	—	27	V
Supply Voltage	VDD		-0.3	—	6	V
OUT Voltage	V_{OUT}		-0.3	—	6	V
SIGN Voltage	V_{SIGN}		-0.3	—	6	V
FILT Voltage	V_{FILT}		-0.3	—	6	V
CLATCH Voltage	V_{CLATCH}		-0.3	—	6	V
COUT Voltage	V_{COUT}		-0.3	—	6	V
VREF Voltage	V_{VREF}		-0.3	—	6	V
CIN+ Voltage	V_{CIN+}		-0.3	—	VDD + 0.3	V
CIN- Voltage	V_{CIN-}		-0.3	—	VDD + 0.3	V
VBIAS Voltage	V_{VBIAS}		-0.3	—	VDD + 0.3	V
RS+ to RS- Voltage	$V_{RS+} - V_{RS-}$		—	—	27	V
Short Circuit Duration: OUT to GND			—	—	Continuous	
Continuous Input Current (Any Pin)			-20	—	20	mA
Junction Temperature			—	—	150	°C
Storage Temperature Range			-65	—	150	°C
Lead Temperature (Soldering, 10 s)			—	—	300	°C
Soldering Temperature (Reflow)			—	—	260	°C
ESD Tolerance						
Human Body Model			—	—	2000	V
Machine Model			—	—	200	V

For the following graphs, $V_{RS+} = V_{RS-} = 3.6\text{ V}$; $V_{DD} = 3\text{ V}$; $V_{REF} = \text{GND}$; $V_{BIAS} = 1.5\text{ V}$, $C_{IN+} = 0.75\text{ V}$, $CLATCH = V_{DD}$, $C_{IN-} = \text{OUT}$, $R_{FET} = 1\text{ M}\Omega$, $C_{FET} = 820\text{ pF}$, and $T_A = +25\text{ C}$ unless otherwise noted.

Positive Gain Error Histogram

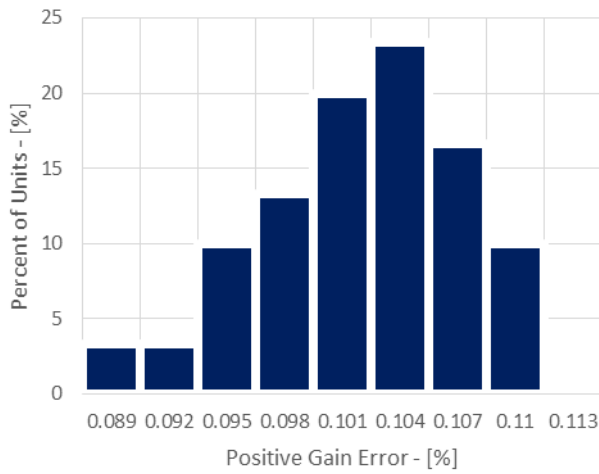

Negative Gain Error Histogram

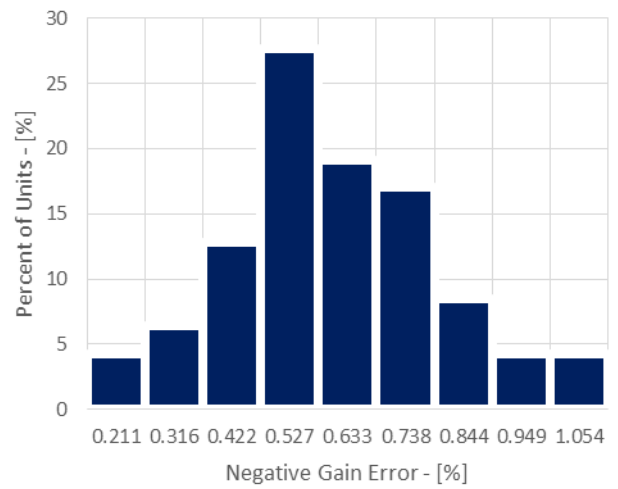

CSA Input Offset Voltage Histogram

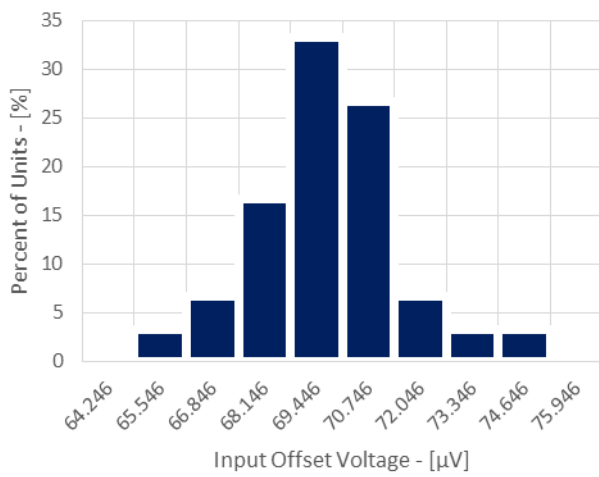

CSA Input Offset vs Common Mode Voltage

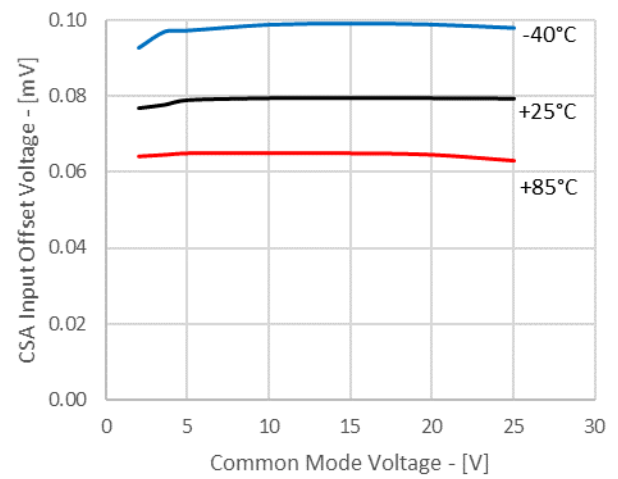

CSA Supply Current vs Common Mode Voltage

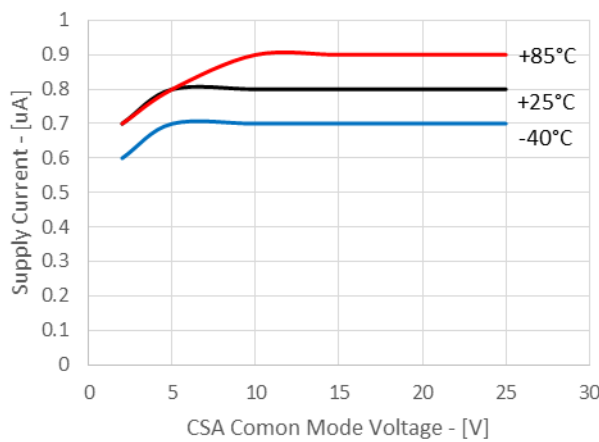

Supply Current vs VDD

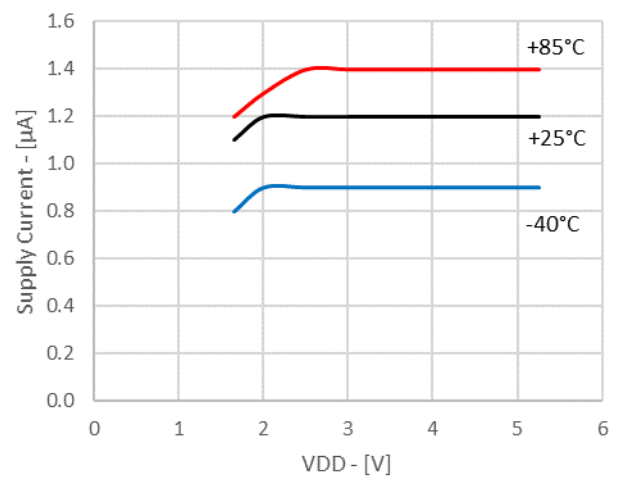

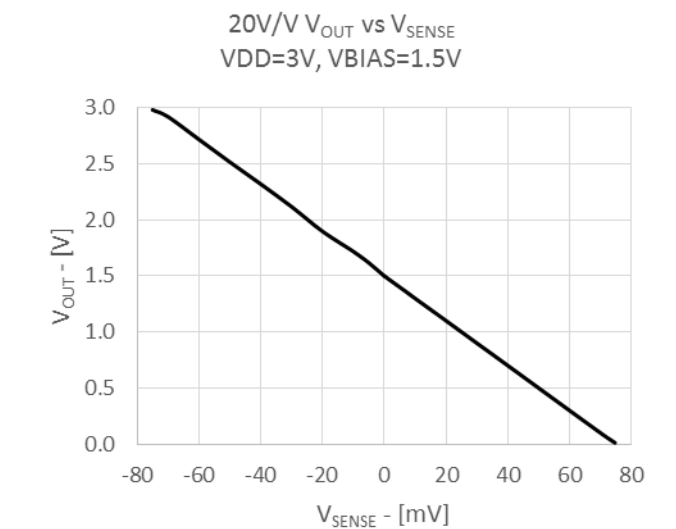
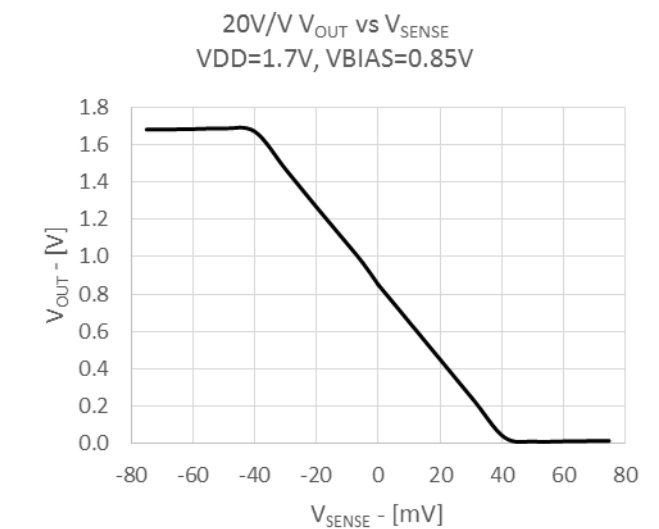
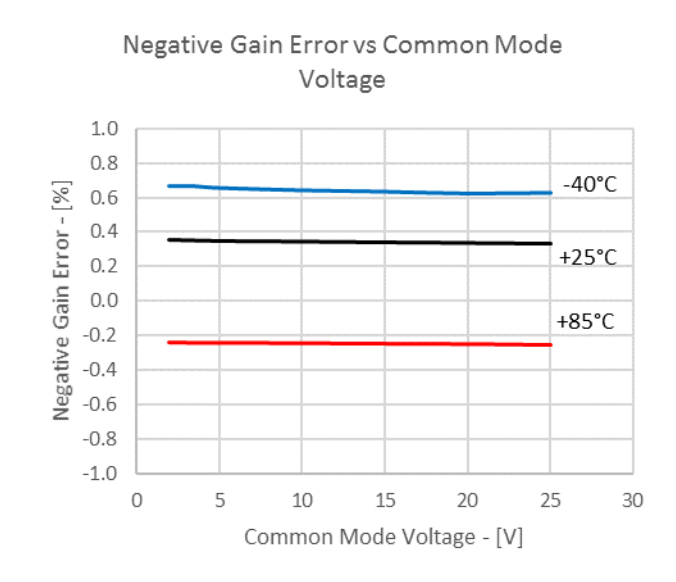
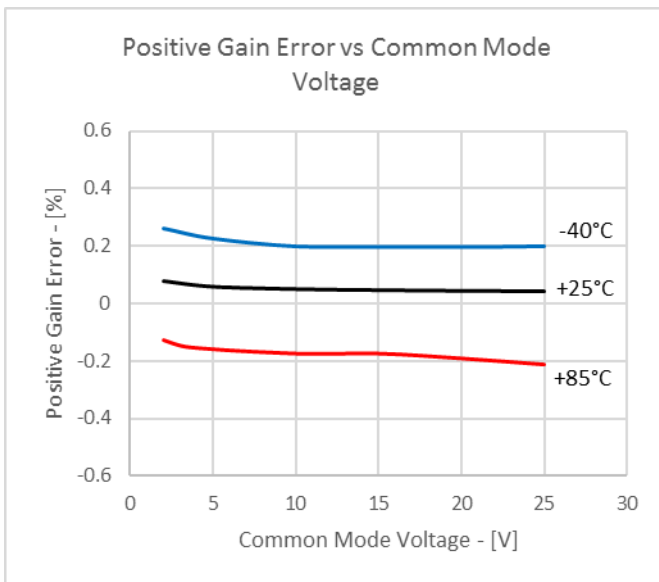
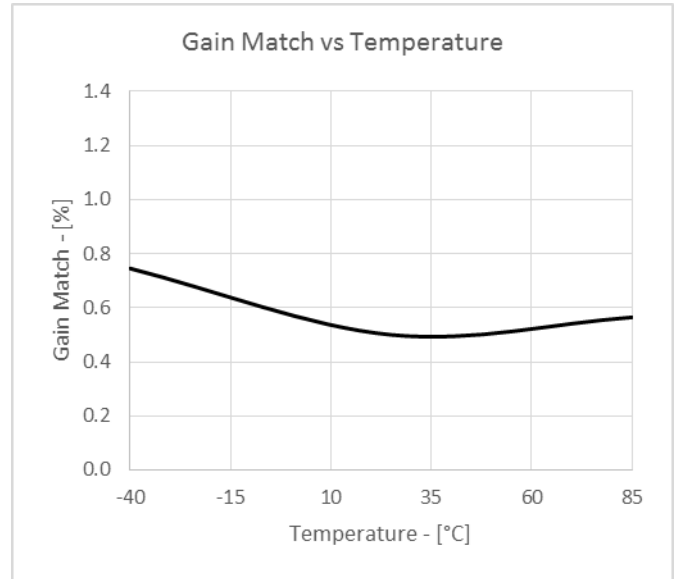
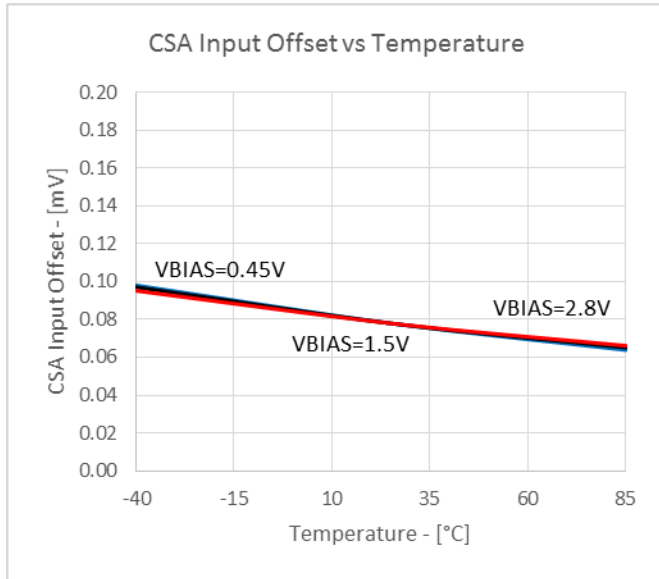

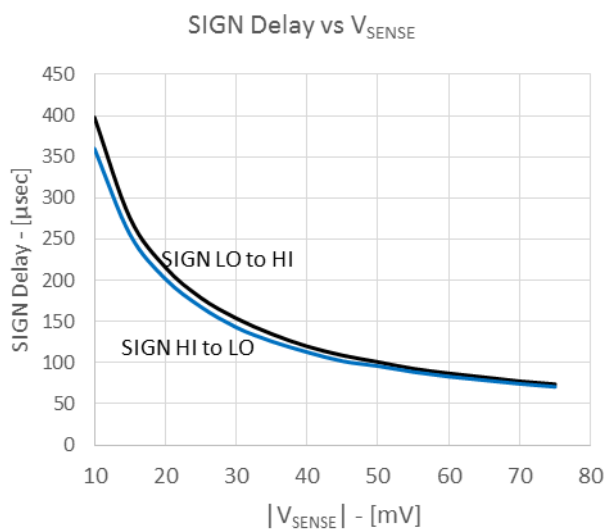
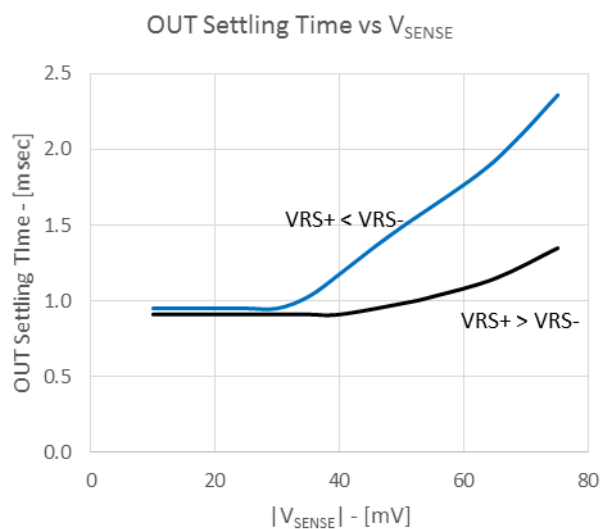
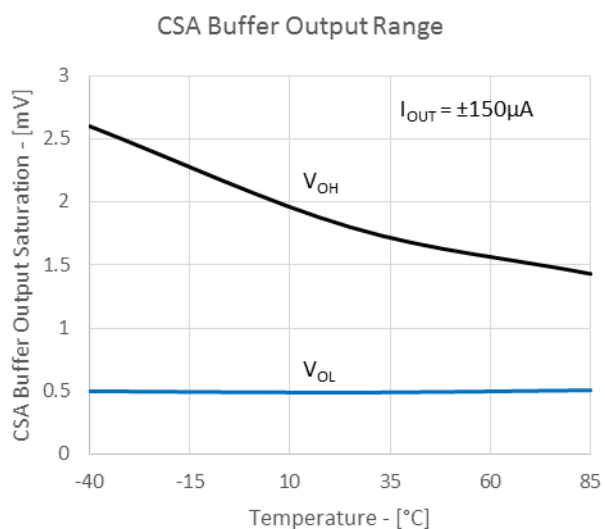
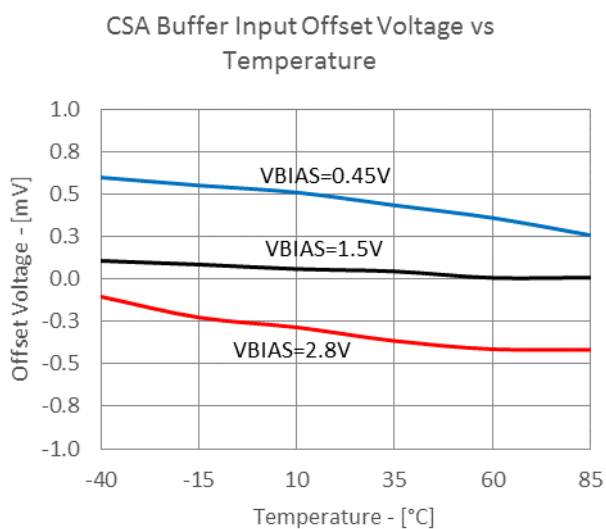
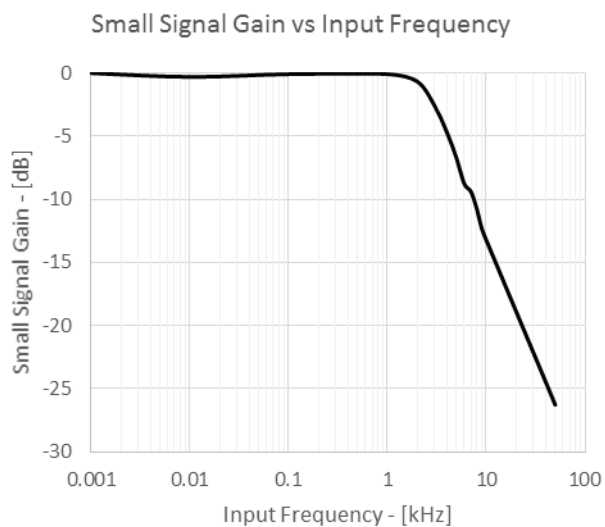
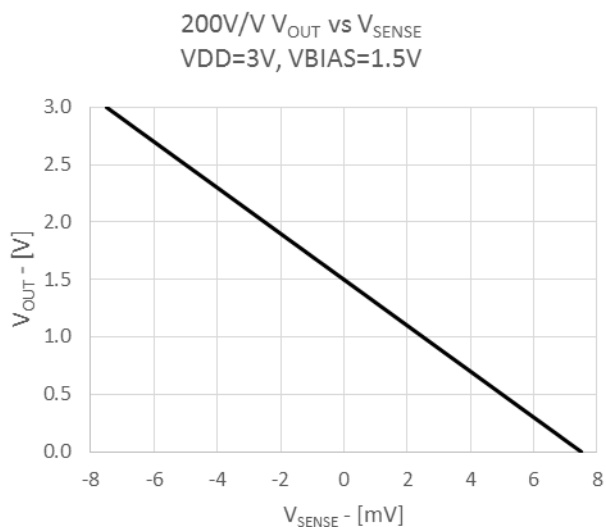

Current Limit Delay vs Overdrive

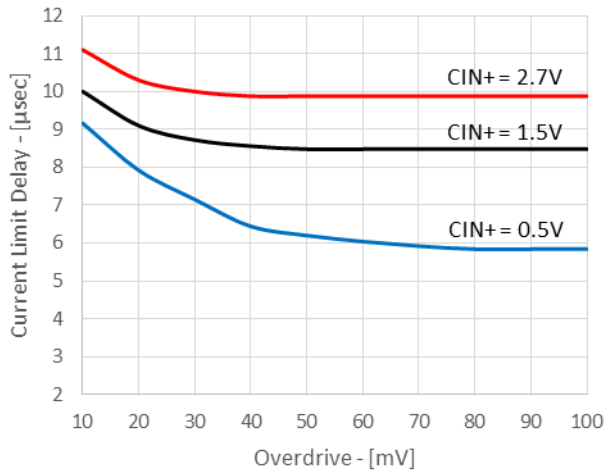

Current Limit Delay vs Capacitive Load

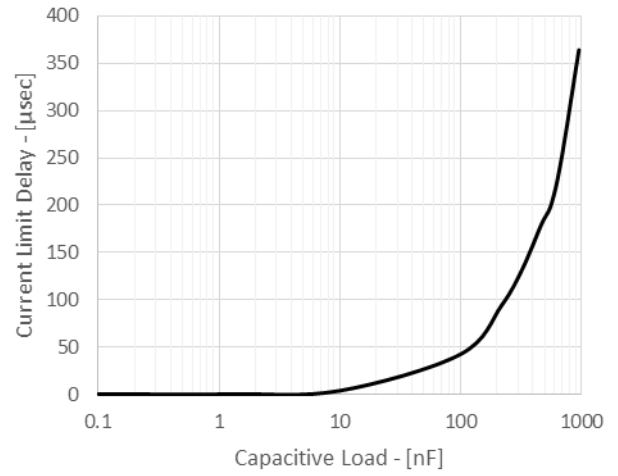

FET ON Time vs Gate Capacitance

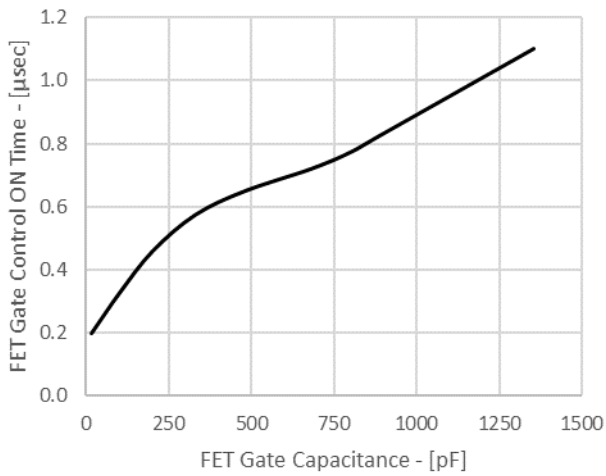

FET OFF Time vs Gate Capacitance

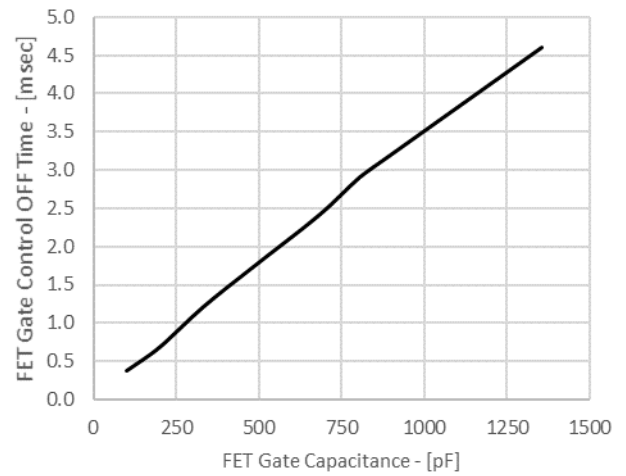

VBIAS Variation Over Temperature

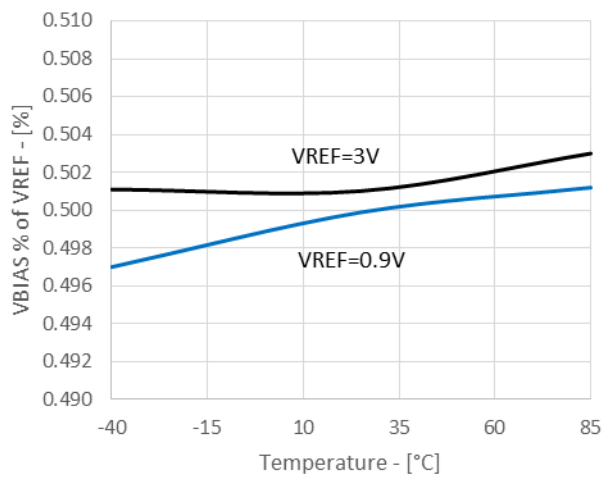

Small Signal Pulse Response

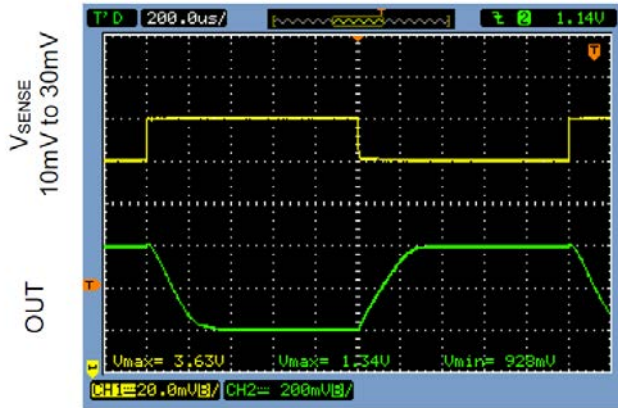

Large Signal Pulse Response

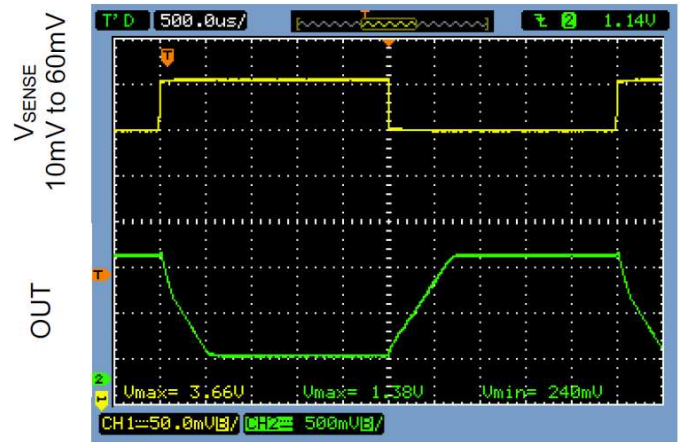

Circuit Breaker with Current Limiter
VBIAS=1.5V, CIN+=0.75V

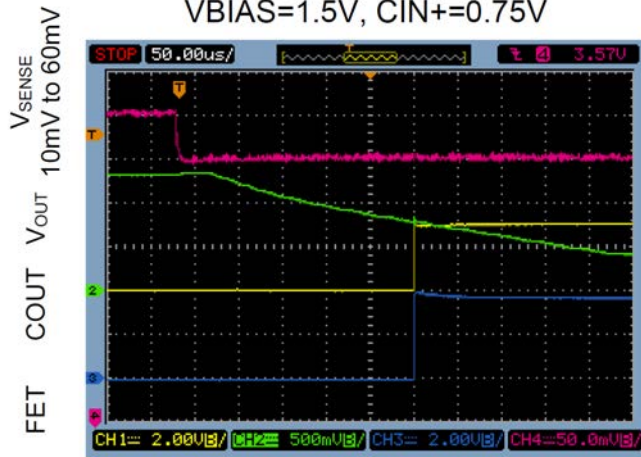

Current Limiter Falling Edge
VBIAS=1.5V, CIN+=0.75V

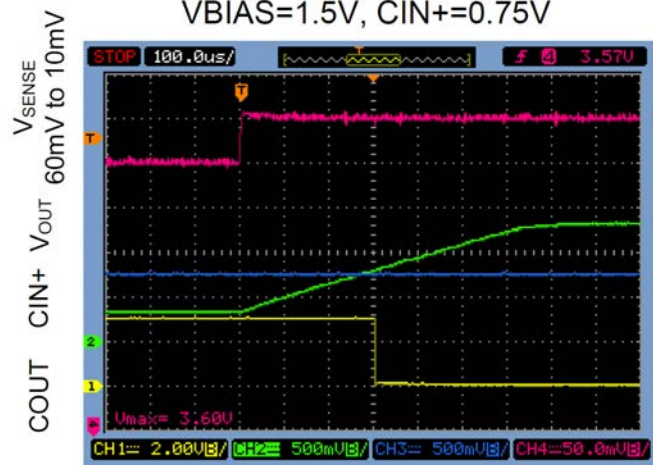

FET Gate Control ON Time
VBIAS=1.5V, CIN+=0.75V, CFET=820pF

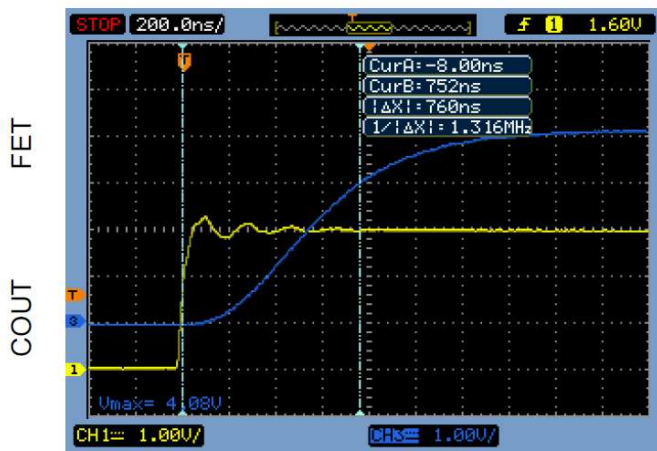

FET Gate Control OFF Time
VBIAS=1.5V, CIN+=0.75V, CFET=820pF

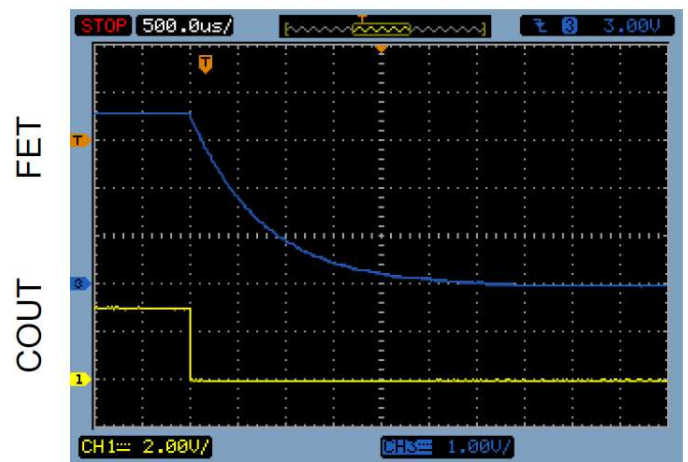

4. Typical Application Circuit

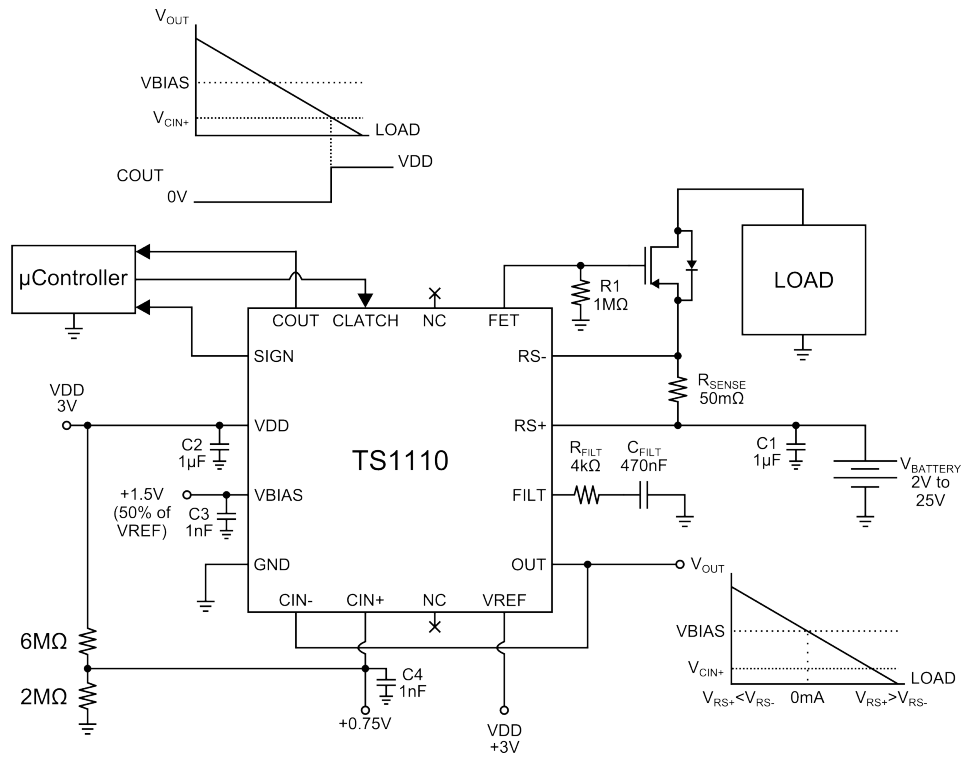

Figure 4.1. TS1110 Typical Application Circuit

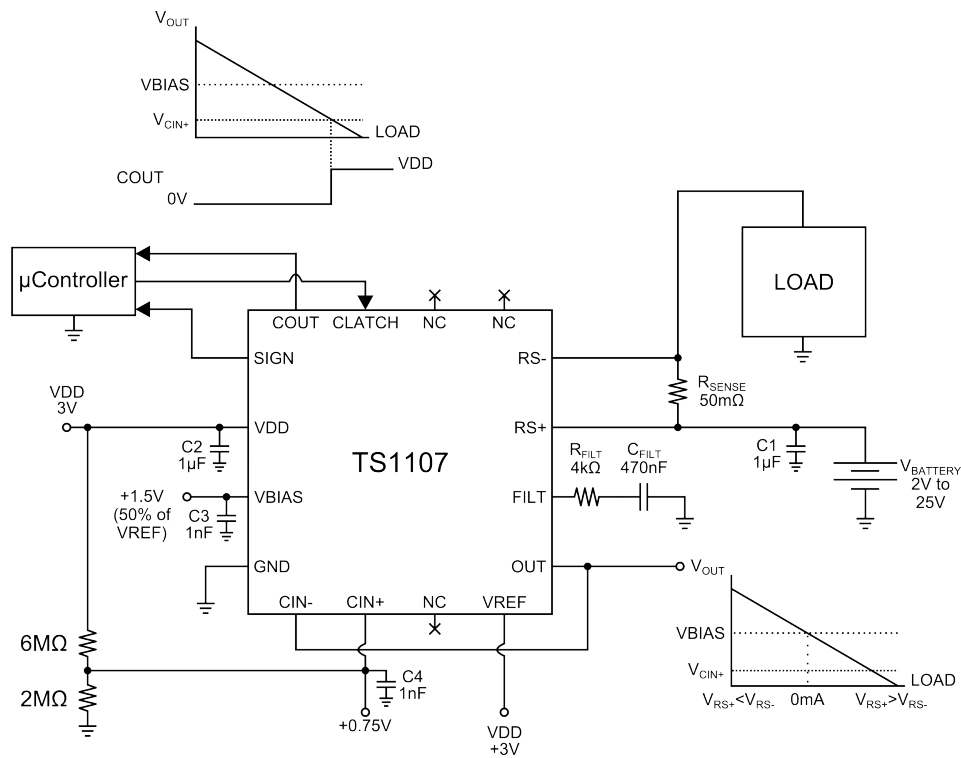

Figure 4.2. TS1107 Typical Application Circuit

5. Pin Descriptions

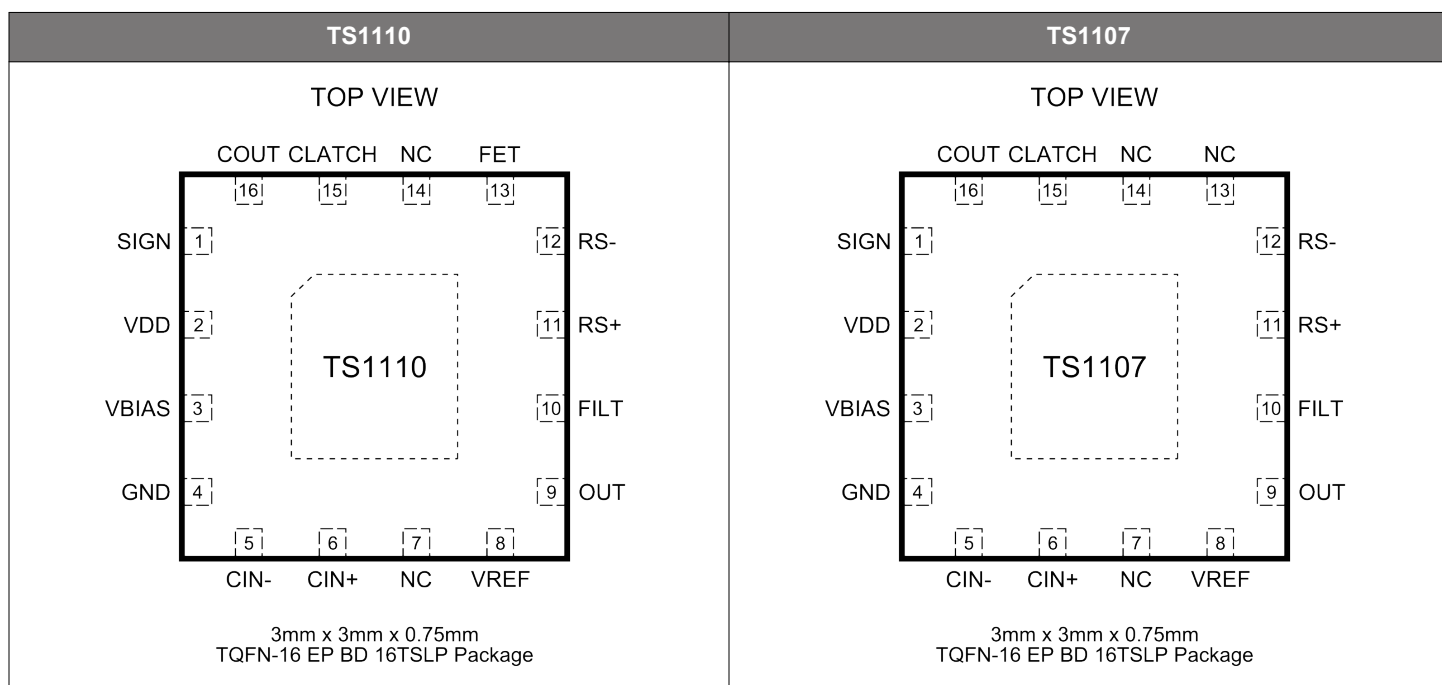

Table 5.1. Pin Descriptions

Pin	Label	Function
1	SIGN	Sign output. SIGN is HIGH for $V_{RS+} > V_{RS-}$ and LOW for $V_{RS-} > V_{RS+}$.
2	VDD	External power supply pin. Connect this to the system's VDD supply.
3	VBIAS	Bias voltage for CSA output. When VREF is activated, leave open.
4	GND	Ground. Connect to analog ground.
5	CIN-	Inverting terminal of Current Limiter Comparator. Connect to OUT.
6	CIN+	Non-inverting terminal of Current Limiter Comparator. Connect an external reference voltage to set current limit.
7	NC	No connection. Leave open.
8	VREF	Voltage reference. To activate, a minimum voltage of 0.9V is required. To disable voltage divider, connect to analog ground, GND.
9	OUT	CSA buffered output. Connect to CIN-.
10	FILT	Inverting terminal of CSA Buffer. Connect a series RC Filter of 4k Ω and 0.47 μ F, otherwise leave open.
11	RS+	External Sense Resistor Power-Side Connection
12	RS-	External Sense Resistor Load-Side Connection. For TS1110 only, connect external PFET's source to RS- pin and connect load to PFET's drain. For TS1107, connect load directly to RS- pin.
13	FET	TS1110 External PFET Gate Connection. Connect an external pull-down resistor of 1M Ω .
	NC	TS1107 No connection. Leave open.
14	NC	No connection. Leave open.
15	CLATCH	Current Limiter Comparator Latch Enable. CLATCH must be HIGH for latch enable. To disable latch, CLATCH must be held LOW.
16	COUT	Current Limiter Comparator Output.
Exposed Pad	EPAD	Exposed backside paddle. For best electrical and thermal performance, solder to analog ground.

6. Packaging

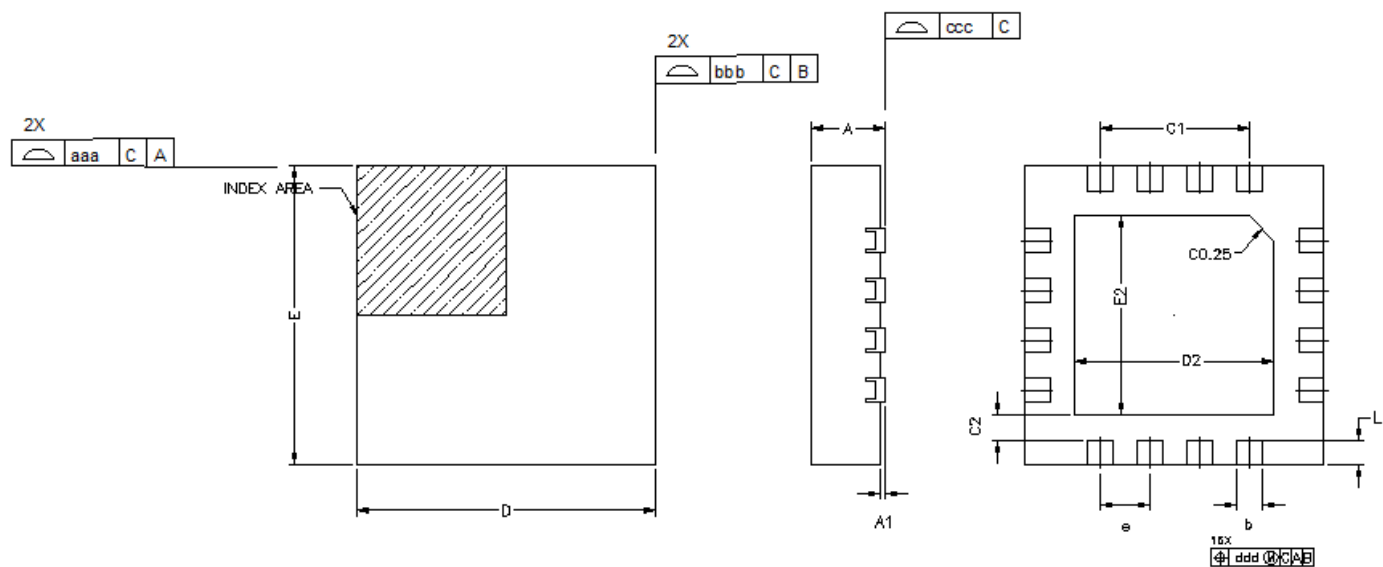

Figure 6.1. TS1107/10 3x3 mm 16-QFN Package Diagram

Table 6.1. Package Dimensions

Dimension	Min	Nom	Max
A	0.70	0.75	0.80
A1	0.00	0.02	0.05
b	0.20	0.25	0.30
C1	1.50 REF		
C2	0.25 REF		
D	3.00 BSC		
D2	1.90	2.00	2.10
e	0.50 BSC		
E	3.00 BSC		
E2	1.90	2.00	2.10
L	0.20	0.25	0.30
aaa	—	—	0.05
bbb	—	—	0.05
ccc	—	—	0.05
ddd	—	—	0.10

Note:

1. All dimensions shown are in millimeters (mm) unless otherwise noted.
2. Dimensioning and Tolerancing per ANSI Y14.5M-1994.

7. Top Marking

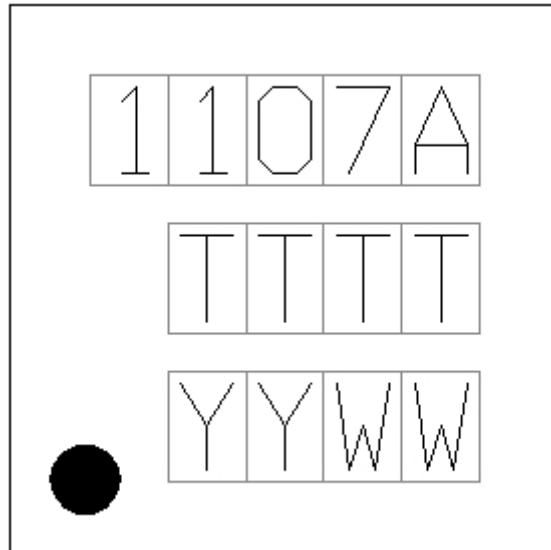
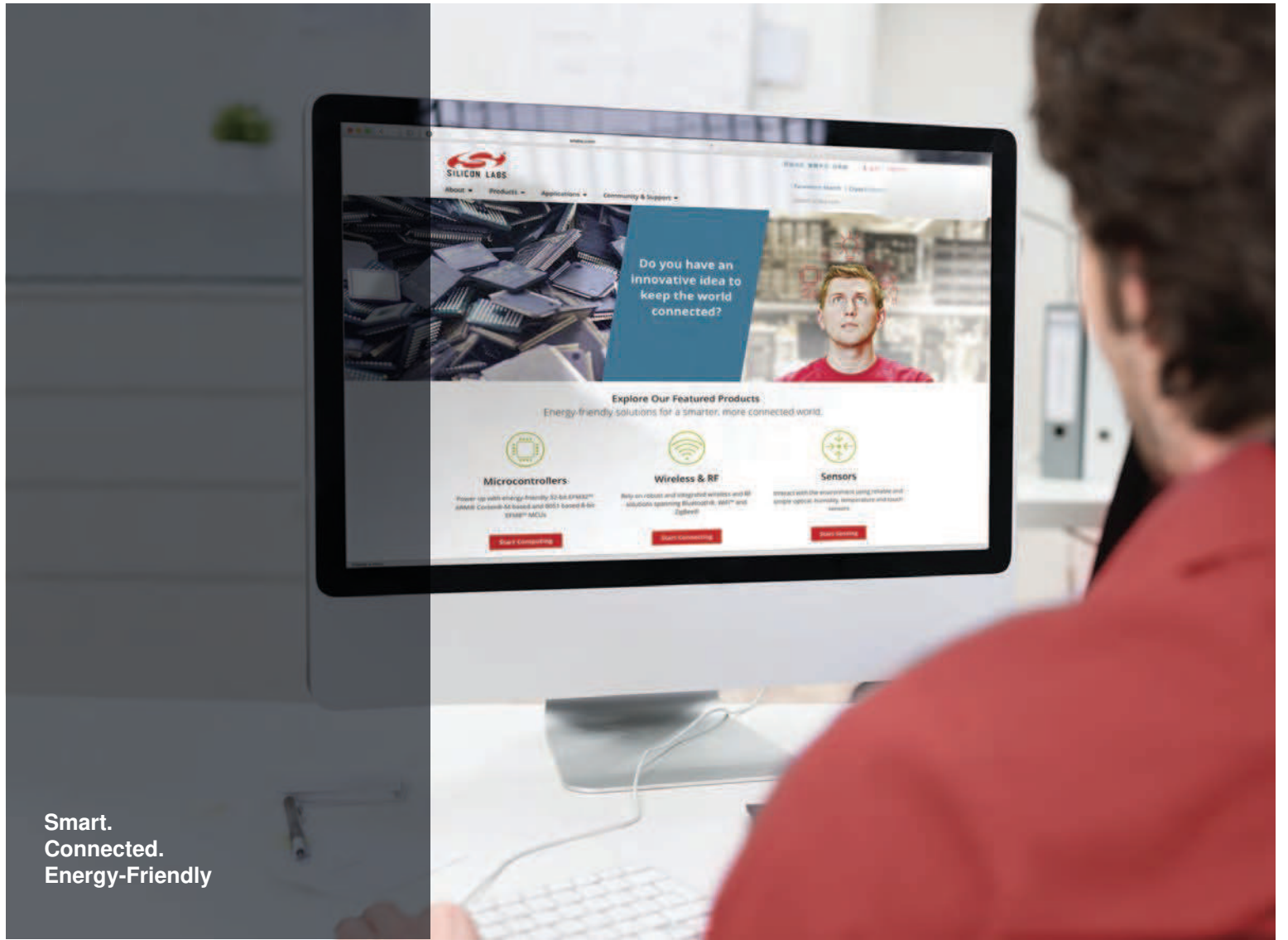

Figure 7.1. Top Marking

Table 7.1. Top Marking Explanation

Mark Method	Laser	
Pin 1 Mark:	Circle = 0.50 mm Diameter (lower left corner)	
Font Size:	0.50 mm (20 mils)	
Line 1 Mark Format:	Product ID	Note: A = 20 gain, B = 200 gain
Line 2 Mark Format:	TTTT – Mfg Code	Manufacturing code
Line 3 Mark Format:	YY = Year; WW = Work Week	Year and week of assembly

1. Ordering Information	1
2. System Overview	2
2.1 Functional Block Diagrams	2
2.2 Current Sense Amplifier + Output Buffer	3
2.3 Sign Output	4
2.4 Current Limit Comparator	4
2.5 FET Control (TS1110 Only)	4
2.6 VREF Divider	4
2.7 Selecting a Sense Resistor	5
2.7.1 RSENSE Voltage Loss	5
2.7.2 VOUT Swing vs. Desired VSENSE and Applied Supply Voltage at VDD.	5
2.7.3 Total Load Current Accuracy	5
2.7.4 Circuit Efficiency and Power Dissipation	5
2.7.5 RSENSE Kelvin Connections	6
2.7.6 RSENSE Composition	6
2.7.7 Internal Noise Filter	6
2.7.8 PC Board Layout and Power-Supply Bypassing	6
3. Electrical Characteristics	7
4. Typical Application Circuit	16
5. Pin Descriptions	17
6. Packaging	18
7. Top Marking	19



Smart.
Connected.
Energy-Friendly



Products
www.silabs.com/products

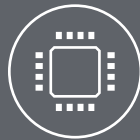

Quality
www.silabs.com/quality



Support and Community
community.silabs.com

Disclaimer

Silicon Laboratories intends to provide customers with the latest, accurate, and in-depth documentation of all peripherals and modules available for system and software implementers using or intending to use the Silicon Laboratories products. Characterization data, available modules and peripherals, memory sizes and memory addresses refer to each specific device, and "Typical" parameters provided can and do vary in different applications. Application examples described herein are for illustrative purposes only. Silicon Laboratories reserves the right to make changes without further notice and limitation to product information, specifications, and descriptions herein, and does not give warranties as to the accuracy or completeness of the included information. Silicon Laboratories shall have no liability for the consequences of use of the information supplied herein. This document does not imply or express copyright licenses granted hereunder to design or fabricate any integrated circuits. The products must not be used within any Life Support System without the specific written consent of Silicon Laboratories. A "Life Support System" is any product or system intended to support or sustain life and/or health, which, if it fails, can be reasonably expected to result in significant personal injury or death. Silicon Laboratories products are generally not intended for military applications. Silicon Laboratories products shall under no circumstances be used in weapons of mass destruction including (but not limited to) nuclear, biological or chemical weapons, or missiles capable of delivering such weapons.

Trademark Information

Silicon Laboratories Inc., Silicon Laboratories, Silicon Labs, SiLabs and the Silicon Labs logo, CMEMS®, EFM, EFM32, EFR, Energy Micro, Energy Micro logo and combinations thereof, "the world's most energy friendly microcontrollers", Ember®, EZLink®, EZMac®, EZRadio®, EZRadioPRO®, DSPLL®, ISOmodem®, Precision32®, ProSLIC®, SiPHY®, USBXpress® and others are trademarks or registered trademarks of Silicon Laboratories Inc. ARM, CORTEX, Cortex-M3 and THUMB are trademarks or registered trademarks of ARM Holdings. Keil is a registered trademark of ARM Limited. All other products or brand names mentioned herein are trademarks of their respective holders.



SILICON LABS

Silicon Laboratories Inc.
400 West Cesar Chavez
Austin, TX 78701
USA

<http://www.silabs.com>