



Chipsmall Limited consists of a professional team with an average of over 10 year of expertise in the distribution of electronic components. Based in Hongkong, we have already established firm and mutual-benefit business relationships with customers from,Europe,America and south Asia,supplying obsolete and hard-to-find components to meet their specific needs.

With the principle of "Quality Parts,Customers Priority,Honest Operation,and Considerate Service",our business mainly focus on the distribution of electronic components. Line cards we deal with include Microchip,ALPS,ROHM,Xilinx,Pulse,ON,Everlight and Freescale. Main products comprise IC,Modules,Potentiometer,IC Socket,Relay,Connector.Our parts cover such applications as commercial,industrial, and automotives areas.

We are looking forward to setting up business relationship with you and hope to provide you with the best service and solution. Let us make a better world for our industry!



Contact us

Tel: +86-755-8981 8866 Fax: +86-755-8427 6832

Email & Skype: info@chipsmall.com Web: www.chipsmall.com

Address: A1208, Overseas Decoration Building, #122 Zhenhua RD., Futian, Shenzhen, China



A 1.55V to 5.25V, 1.9µA, 9kHz to 300kHz Silicon Timer

FEATURES

- 5V Supply Voltage
- FOUT/PWMOUT Output Period: 40µs(25kHz)
 - RSET = 4.32MΩ
- PWMOUT Output Duty Cycle:
 - 75% with CPWM = 100pF
- PWMOUT Duty Cycle Reduction
 - 1MΩ Potentiometer
- Fully Assembled and Tested
- 2in x 2in 2-layer circuit board

COMPONENT LIST

DESIGNATION	QTY	DESCRIPTION
C1	1	100pF ±10% capacitor (0805)
C2	1	4.7µF ±10% capacitor (0805)
R2	1	10MΩ ± 1% (0805)
R1	1	4.32MΩ ± 1% (0805)
PWM_ADJ	1	1MΩ Potentiometer
U1	1	TS3003
VDD,F_OUT, PWM_OUT	3	Test points
J1	1	Jumper

DESCRIPTION

The TS3003 is a single-supply, second-generation oscillator/timer fully specified to operate at a supply voltage range of 1.55V to 5.25V while consuming less than 2.4µA(max) supply current. Requiring only a resistor to set the base output frequency (or output period) at 25kHz (or 40µs) with a 50% duty cycle, the TS3003 timer/oscillator is compact, easy-to-use, and versatile. Optimized for ultra-long life, low frequency, battery-powered/portable applications, the TS3003 joins the TS3001, TS3002, TS3004, and TS3006 in the timer family of the “NanoWatt Analog™” series of high-performance analog integrated circuits.

The TS3003 requires only an RSET = 4.32MΩ resistor to set the FOUT/PWMOUT output period to 40µs(25kHz). With an on-board 100pF CPWM capacitor, the duty cycle of PWMOUT is set at approximately 75%. Further reduction of the duty cycle is available with an on-board 1MΩ potentiometer. The complete circuit is designed at a supply voltage of 5V. The TS3003 is fully specified over the -40°C to +85°C temperature range and is available in a low-profile, 10-pin 3x3mm TDFN package with an exposed back-side paddle.

Product data sheet and additional documentation can be found at www.silabs.com.

ORDERING INFORMATION

Order Number	Description
TS3003DB	TS3003 Demo Board

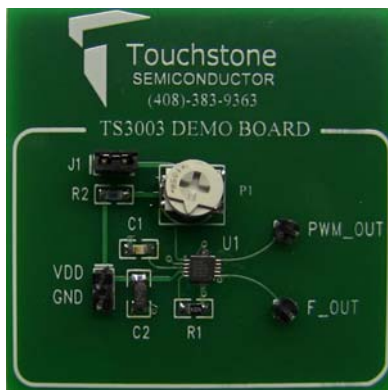

Figure 1. TS3003 Demo Board (Top View)



Figure 2. TS3003 Demo Board (Bottom View)

DESCRIPTION

The TS3003 requires only an $R_{SET} = 4.32M\Omega$ resistor to set the FOUT/PWMOUT output period to $40\mu s$ (25kHz). With an on-board 100pF CPWM capacitor, the duty cycle of PWMOUT is set at approximately 75%. Further reduction of the duty cycle is available with an on-board 1M Ω potentiometer. The complete circuit is designed at a supply voltage of 5V and it is shown in Figure 1.

The TS3003 is a user-programmable oscillator where the period of the square wave at its FOUT terminal is generated by an external resistor connected to the RSET pin. The output period is given by:

$$F_{OUT} \text{ (Hz)} = \frac{1.08E11}{R_{SET}}$$

Equation 1. FOUT Frequency Calculation

With $R_{SET} = 4.32M\Omega$, the FOUT period is approximately $40\mu s$ (25kHz) with a 50% duty cycle. As design aids, Table 1 lists TS3003's typical FOUT frequency for various standard values for R_{SET} .

R_{SET} (M Ω)	FOUT (kHz)
0.360	300
1	108
2.49	43.37
4.32	25
6.81	15.86
9.76	11.07
12	9

Table 1: FOUT vs R_{SET}

The TS3003 also provides a separate PWM output signal at its PWMOUT terminal that is anti-phase with respect to FOUT. To adjust the pulse width of the PWMOUT output, a single capacitor can be placed at the CPWM pin. To determine the capacitance needed for a desired pulse width, the following equation is to be used:

$$CPWM(F) = \frac{\text{Pulse Width(s)} \times I_{CPWM}}{V_{CPWM} \cong 300mV}$$

Equation 2. CPWM Capacitor Calculation

where I_{CPWM} and V_{CPWM} is the current supplied and voltage applied to the CPWM capacitor, respectively.

The pulse width is determined based on the period of FOUT and should never be greater than the period at FOUT. Make sure the PWM_CNTRL pin is set to at least 400mV when calculating the pulse width of PWMOUT. Note V_{CPWM} is approximately 300mV, which is the RSET voltage. Also note that I_{CPWM} is approximately 1 μA .

QUICK START PROCEDURE

Required Equipment

- TS3003 Demo Board
- DC Power Supply
- Oscilloscope Model Agilent DSO1014A or equivalent
- Two 10X, 15pF//10M Ω oscilloscope probes
- Potentiometer screwdriver

To evaluate the TS3003 silicon timer, the following steps are to be performed:

- 1) Before connecting the DC power supply to the demo board, turn on the power supply, set the DC voltage to 5V, and then turn it off.
- 2) Connect the DC power supply positive terminal to the test point labeled VDD. Connect the negative terminal of the DC power supply to the test point labeled GND.
- 3) To monitor the FOUT output signal, connect the signal terminal of an oscilloscope probe to the test point labeled FOUT and the ground terminal to the test point labeled GND.
- 4) To monitor the PWMOUT output signal, connect the signal terminal of a second oscilloscope probe to the test point labeled PWM_OUT and the ground terminal to the test point labeled GND.
- 5) Select two channels on the oscilloscope and set the vertical voltage scale and the vertical position on each channel to 2V/DIV and 0V, respectively. Set the horizontal time scale to 5 μs /DIV. The coupling should be DC coupling. Turn on the power supply.

The supply current will vary depending on the load on the output. Given the default set-up on the board, the FOUT/PWMOUT output period is approximately $40\mu s$. The PWMOUT duty cycle is set to approximately 75%. With an output load of

15pF on both FOUT and PWMOUT outputs due to the oscilloscope probes, the supply current should be less than 8 μ A.

- 6) If further reduction of the duty cycle of the PWMOUT output is desired, turn the potentiometer clockwise. If jumper J1 is removed, the PWM_CNTRL pin is tied to VDD and the potentiometer will not change the PWMOUT output duty cycle.

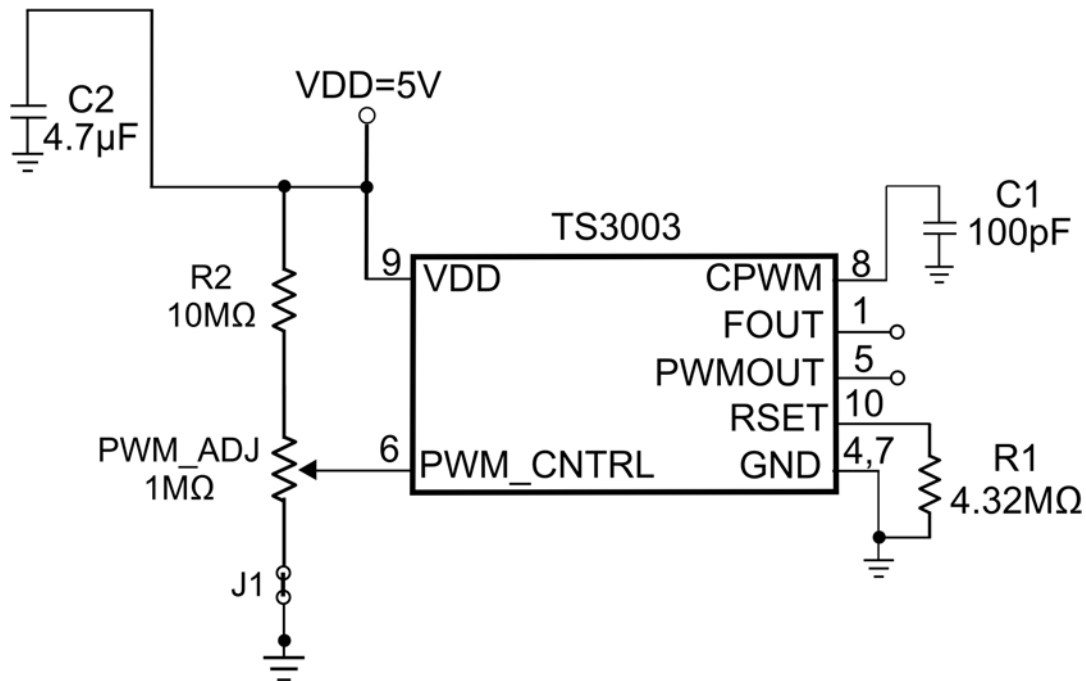

Figure 3. TS3003 Demo Board Circuit

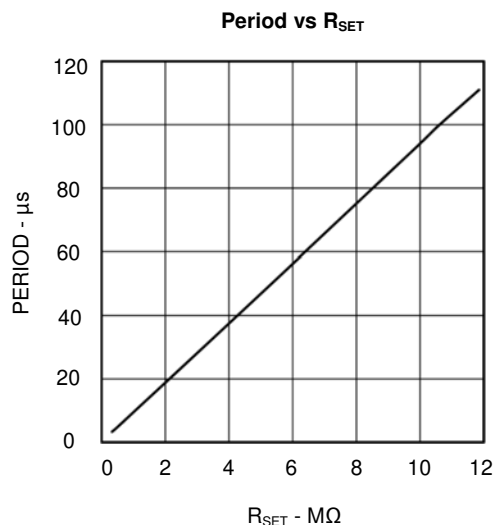

Figure 4. FOUT/PWMOUT Period vs RSET

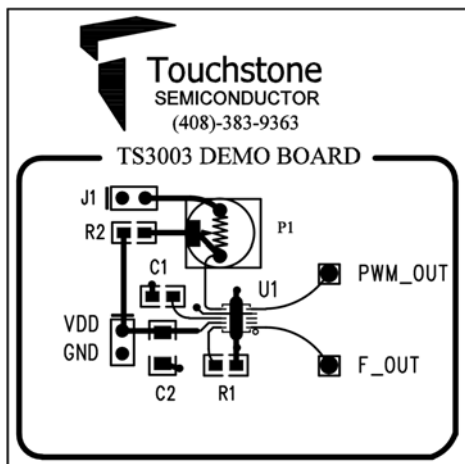

Figure 5. Top Layer View #1

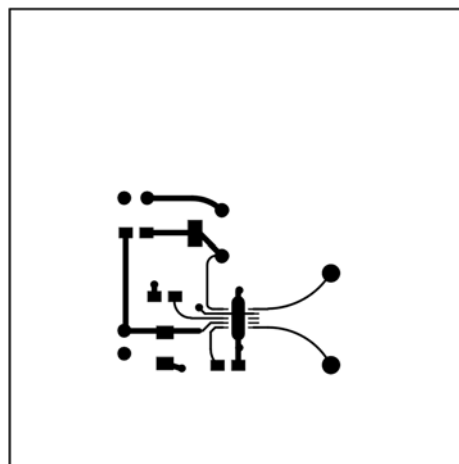

Figure 6. Top Layer View #2

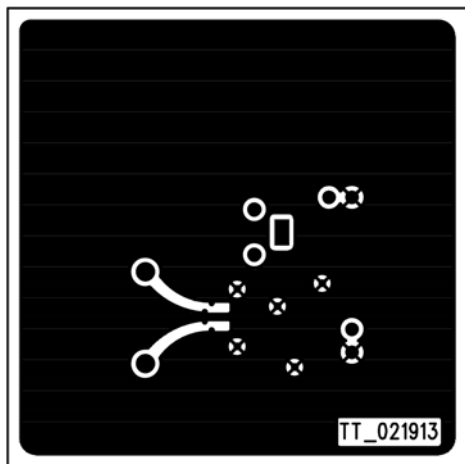

Figure 7. Bottom Layer (GND) #1

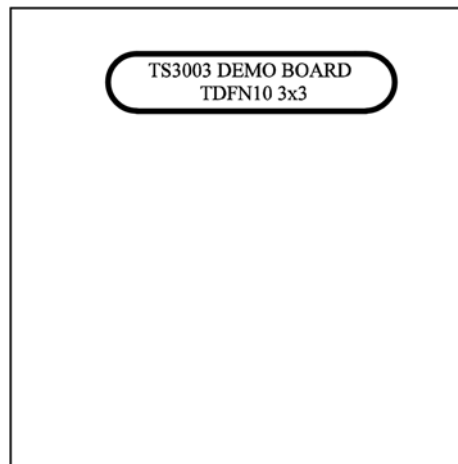
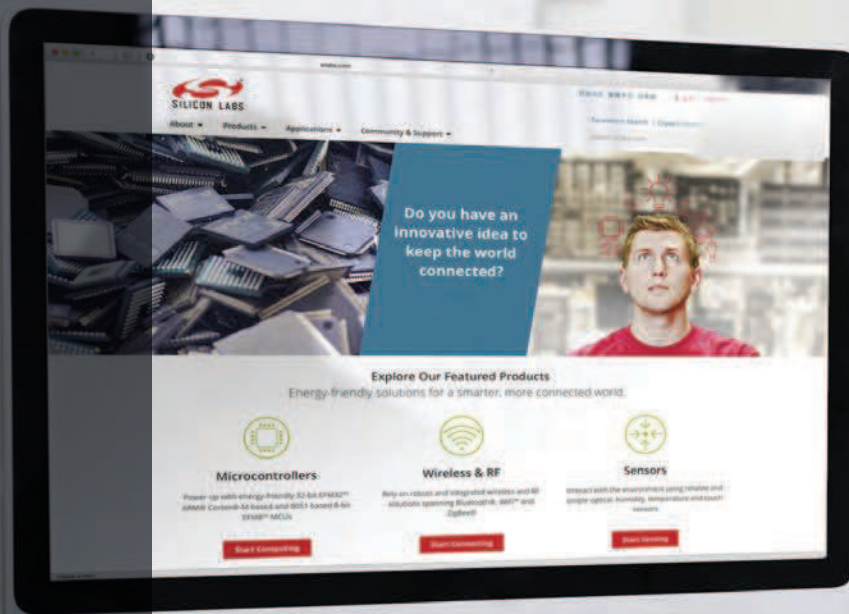

Figure 8. Bottom Layer (GND) #2



Smart.
Connected.
Energy-Friendly



Products
www.silabs.com/products

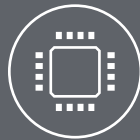

Quality
www.silabs.com/quality



Support and Community
community.silabs.com

Disclaimer

Silicon Laboratories intends to provide customers with the latest, accurate, and in-depth documentation of all peripherals and modules available for system and software implementers using or intending to use the Silicon Laboratories products. Characterization data, available modules and peripherals, memory sizes and memory addresses refer to each specific device, and "Typical" parameters provided can and do vary in different applications. Application examples described herein are for illustrative purposes only. Silicon Laboratories reserves the right to make changes without further notice and limitation to product information, specifications, and descriptions herein, and does not give warranties as to the accuracy or completeness of the included information. Silicon Laboratories shall have no liability for the consequences of use of the information supplied herein. This document does not imply or express copyright licenses granted hereunder to design or fabricate any integrated circuits. The products must not be used within any Life Support System without the specific written consent of Silicon Laboratories. A "Life Support System" is any product or system intended to support or sustain life and/or health, which, if it fails, can be reasonably expected to result in significant personal injury or death. Silicon Laboratories products are generally not intended for military applications. Silicon Laboratories products shall under no circumstances be used in weapons of mass destruction including (but not limited to) nuclear, biological or chemical weapons, or missiles capable of delivering such weapons.

Trademark Information

Silicon Laboratories Inc., Silicon Laboratories, Silicon Labs, SiLabs and the Silicon Labs logo, CMEMS®, EFM, EFM32, EFR, Energy Micro, Energy Micro logo and combinations thereof, "the world's most energy friendly microcontrollers", Ember®, EZLink®, EZMac®, EZRadio®, EZRadioPRO®, DSPLL®, ISOmodem®, Precision32®, ProSLIC®, SiPHY®, USBXpress® and others are trademarks or registered trademarks of Silicon Laboratories Inc. ARM, CORTEX, Cortex-M3 and THUMB are trademarks or registered trademarks of ARM Holdings. Keil is a registered trademark of ARM Limited. All other products or brand names mentioned herein are trademarks of their respective holders.



SILICON LABS

Silicon Laboratories Inc.
400 West Cesar Chavez
Austin, TX 78701
USA

<http://www.silabs.com>