



Chipsmall Limited consists of a professional team with an average of over 10 year of expertise in the distribution of electronic components. Based in Hongkong, we have already established firm and mutual-benefit business relationships with customers from,Europe,America and south Asia,supplying obsolete and hard-to-find components to meet their specific needs.

With the principle of “Quality Parts,Customers Priority,Honest Operation,and Considerate Service”,our business mainly focus on the distribution of electronic components. Line cards we deal with include Microchip,ALPS,ROHM,Xilinx,Pulse,ON,Everlight and Freescale. Main products comprise IC,Modules,Potentiometer,IC Socket,Relay,Connector.Our parts cover such applications as commercial,industrial, and automotives areas.

We are looking forward to setting up business relationship with you and hope to provide you with the best service and solution. Let us make a better world for our industry!



Contact us

Tel: +86-755-8981 8866 Fax: +86-755-8427 6832

Email & Skype: info@chipsmall.com Web: www.chipsmall.com

Address: A1208, Overseas Decoration Building, #122 Zhenhua RD., Futian, Shenzhen, China



Rail-to-rail high-speed comparator

Datasheet - production data

SOT23-5/SC70-5

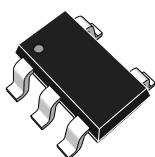

Features

- Propagation delay: 8 ns
- Low current consumption: 470 μ A typ at 5 V
- Rail-to-rail inputs
- Push-pull outputs
- Supply operation from 2.2 to 5 V
- Wide temperature range: -40 °C to 125 °C
- ESD tolerance: 2 kV HBM/200 V MM
- Latch-up immunity: 200 mA
- SMD packages
- Automotive qualification

Applications

- Telecoms
- Instrumentation
- Signal conditioning
- High-speed sampling systems
- Portable communication systems

Description

The TS3011 single comparator features a high-speed response time with rail-to-rail inputs. Specified for a supply voltage of 2.2 to 5 V, this comparator can operate over a wide temperature range from -40 °C to 125 °C.

The TS3011 offers micropower consumption as low as a few hundred microamperes, thus providing an excellent ratio of power consumption current versus response time.

The TS3011 includes push-pull outputs and is available in small packages (SMD): SOT23-5 and SC70-5.

Contents

1	Package pin connections.....	3
2	Absolute maximum ratings and operating conditions	4
3	Electrical characteristics	5
4	Electrical characteristic curves	11
5	Package information	14
	5.1 SOT23-5 package information	15
	5.2 SC70-5 (or SOT323-5) package information.....	16
6	Ordering information.....	17
7	Revision history	18

1 Package pin connections

Figure 1: Pin connections (top view)

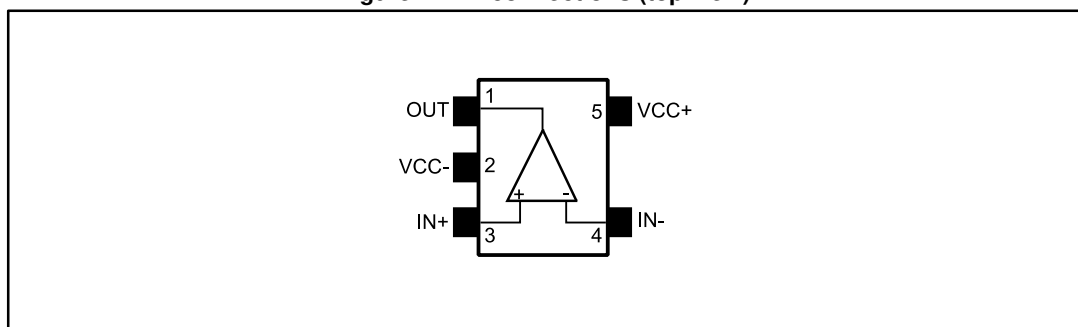

2 Absolute maximum ratings and operating conditions

Table 1: Absolute maximum ratings

Symbol	Parameter	Value	Unit	
V _{CC}	Supply voltage ⁽¹⁾	5.5	V	
V _{ID}	Differential input voltage ⁽²⁾	±5		
V _{IN}	Input voltage range	(V _{CC} ⁻) - 0.3 to (V _{CC} ⁺) + 0.3		
R _{THJA}	Thermal resistance junction-to-ambient ⁽³⁾	SOT23-5	250	°C/W
		SC70-5	205	
R _{THJC}	Thermal resistance junction-to-case ⁽³⁾	SOT23-5	81	
		SC70-5	172	
T _{STG}	Storage temperature	-65 to 150	°C	
T _J	Junction temperature	150		
T _{LEAD}	Lead temperature (soldering 10 seconds)	260		
ESD	Human body model (HBM) ⁽⁴⁾		2000	V
	Machine model (MM) ⁽⁵⁾		200	
	Charged device model (CDM) ⁽⁶⁾	SOT23-5	1500	
		SC70-5	1300	
	Latch-up immunity	200	mA	

Notes:

⁽¹⁾All voltage values, except the differential voltage, are referenced to V_{CC}⁻.

⁽²⁾The magnitude of input and output voltages must never exceed the supply rail ±0.3 V.

⁽³⁾Short-circuits can cause excessive heating. These values are typical.

⁽⁴⁾Human body model: a 100 pF capacitor is charged to the specified voltage, then discharged through a 1.5 kΩ resistor between two pins of the device. This is done for all couples of connected pin combinations while the other pins are floating.

⁽⁵⁾Machine model: a 200 pF capacitor is charged to the specified voltage, then discharged directly between two pins of the device with no external series resistor (internal resistor < 5 Ω). This is done for all couples of connected pin combinations while the other pins are floating.

⁽⁶⁾Charged device model: all pins and package are charged together to the specified voltage and then discharged directly to ground.

Table 2: Operating conditions

Symbol	Parameter	Value	Unit
T _{Oper}	Operating temperature range	-40 to 125	°C
V _{CC}	Supply voltage (V _{CC} ⁺ - V _{CC} ⁻), -40 °C < T _{amb} < 125 °C	2.2 to 5	V
V _{ICM}	Common mode input voltage range, -40 °C < T _{amb} < 125 °C	(V _{CC} ⁻) - 0.2 to (V _{CC} ⁺) + 0.2	

3 Electrical characteristics

In the electrical characteristic tables below, all values over the temperature range are guaranteed through correlation and simulation. No production tests are performed at the temperature range limits.

Table 3: VCC = 2.2 V, VICM = VCC/2, Tamb = 25 °C (unless otherwise specified)

Symbol	Parameter	Test conditions	Min.	Typ.	Max.	Unit
V _{IO}	Input offset voltage ⁽¹⁾		-7	-0.2	7	mV
		-40 °C < T _{amb} < 125 °C	-8		8	
ΔV _{IO}	Input offset voltage drift	-40 °C < T _{amb} < 125 °C		5	20	μV/°C
V _{HYST}	Input hysteresis voltage ⁽²⁾			2		mV
I _{IO}	Input offset current ⁽³⁾			1	20	pA
		-40 °C < T _{amb} < 125 °C			100	
I _{IB}	Input bias current			1	20	pA
		-40 °C < T _{amb} < 125 °C			100	
I _{CC}	Supply current	No load, output high		0.52	0.64	mA
		No load, output high, -40 °C < T _{amb} < 125 °C			0.9	
		No load, output low		0.65	0.88	
		No load, output low, -40 °C < T _{amb} < 125 °C			1.1	
I _{SC}	Short circuit current	Source	14	18		
		Sink	11	14		
V _{OH}	Output voltage high	I _{source} = 4 mA	1.94	1.97		V
		-40 °C < T _{amb} < 125 °C	1.85			
V _{OL}	Output voltage low	I _{sink} = 4 mA		150	190	mV
		-40 °C < T _{amb} < 125 °C			250	
CMRR	Common-mode rejection ratio	0 < V _{ICM} < 2.7 V	50	68		dB
T _{PLH}	Propagation delay, low to high output level ⁽⁴⁾	C _L = 12 pF, R _L = 1 MΩ, overdrive = 5 mV		16		ns
		C _L = 12 pF, R _L = 1 MΩ, overdrive = 15 mV		12		
		C _L = 12 pF, R _L = 1 MΩ, overdrive = 50 mV		10	15	
T _{PHL}	Propagation delay, high to low output level ⁽⁵⁾	C _L = 12 pF, R _L = 1 MΩ, overdrive = 5 mV		16		ns
		C _L = 12 pF, R _L = 1 MΩ, overdrive = 15 mV		12		
		C _L = 12 pF, R _L = 1 MΩ, overdrive = 50 mV		10	15	
T _R	Rise time (10 % to 90 %)	C _L = 12 pF, R _L = 1 MΩ, overdrive = 100 mV		3.0		
T _F	Fall time (90 % to 10 %)	C _L = 12 pF, R _L = 1 MΩ, overdrive = 100 mV		2.5		

Notes:

- ⁽¹⁾The offset is defined as the average value of positive (V_{TRIP+}) and negative (V_{TRIP-}) trip points (input voltage differences) requested to change the output state in each direction.
- ⁽²⁾Hysteresis is a built-in feature of the TS3011. It is defined as the voltage difference between the trip points.
- ⁽³⁾Maximum values include unavoidable inaccuracies of the industrial tests.
- ⁽⁴⁾Overdrive is measured with reference to the V_{TRIP+} point.
- ⁽⁵⁾Overdrive is measured with reference to the V_{TRIP-} point.

Table 4: VCC = 2.7 V, VICM = VCC/2, Tamb = 25 °C (unless otherwise specified)

Symbol	Parameter	Test conditions	Min.	Typ.	Max.	Unit
V _{IO}	Input offset voltage ⁽¹⁾		-7	-0.1	7	mV
		-40 °C < T _{amb} < 125 °C	-9		9	
ΔV _{IO}	Input offset voltage drift	-40 °C < T _{amb} < 125 °C		5	20	μV/°C
V _{HYST}	Input hysteresis voltage ⁽²⁾			2		mV
I _{IO}	Input offset current ⁽³⁾			1	20	pA
		-40 °C < T _{amb} < 125 °C			100	
I _{IB}	Input bias current			1	20	pA
		-40 °C < T _{amb} < 125 °C			100	
I _{CC}	Supply current	No load, output high		0.52	0.65	mA
		No load, output high, -40 °C < T _{amb} < 125 °C			0.9	
		No load, output low		0.66	0.89	
		No load, output low, -40 °C < T _{amb} < 125 °C			1.1	
I _{SC}	Short circuit current	Source	24	27		mA
		Sink	19	22		
V _{OH}	Output voltage high	I _{source} = 4 mA	2.48	2.52		V
		-40 °C < T _{amb} < 125 °C	2.40			
V _{OL}	Output voltage low	I _{sink} = 4 mA		130	170	mV
		-40 °C < T _{amb} < 125 °C			220	
CMRR	Common-mode rejection ratio	0 < V _{ICM} < 2.7 V	52	70		dB
T _{PLH}	Propagation delay, low to high output level ⁽⁴⁾	C _L = 12 pF, R _L = 1 MΩ, overdrive = 5 mV		16		ns
		C _L = 12 pF, R _L = 1 MΩ, overdrive = 15 mV		11		
		C _L = 12 pF, R _L = 1 MΩ, overdrive = 50 mV		9	13	
T _{PHL}	Propagation delay, high to low output level ⁽⁵⁾	C _L = 12 pF, R _L = 1 MΩ, overdrive = 5 mV		16		ns
		C _L = 12 pF, R _L = 1 MΩ, overdrive = 15 mV		11		
		C _L = 12 pF, R _L = 1 MΩ, overdrive = 50 mV		9	13	
T _R	Rise time (10 % to 90 %)	C _L = 12 pF, R _L = 1 MΩ, overdrive = 100 mV		2.3		ns
T _F	Fall time (90 % to 10 %)	C _L = 12 pF, R _L = 1 MΩ, overdrive = 100 mV		1.8		ns

Notes:

⁽¹⁾The offset is defined as the average value of positive (V_{TRIP+}) and negative (V_{TRIP-}) trip points (input voltage differences) requested to change the output state in each direction.

⁽²⁾Hysteresis is a built-in feature of the TS3011. It is defined as the voltage difference between the trip points.

⁽³⁾Maximum values include unavoidable inaccuracies of the industrial tests.

⁽⁴⁾Overdrive is measured with reference to the V_{TRIP+} point.

⁽⁵⁾Overdrive is measured with reference to the V_{TRIP-} point.

Table 5: VCC = 5 V, VICM = VCC/2, Tamb = 25 °C (unless otherwise specified)

Symbol	Parameter	Test conditions	Min.	Typ.	Max.	Unit
V _{IO}	Input offset voltage ⁽¹⁾		-7	-0.4	7	mV
		-40 °C < T _{amb} < 125 °C	-9		9	
ΔV _{IO}	Input offset voltage drift	-40 °C < T _{amb} < 125 °C		10	30	μV/°C
V _{HYST}	Input hysteresis voltage ⁽²⁾			2		mV
I _{IO}	Input offset current ⁽³⁾			1	20	pA
		-40 °C < T _{amb} < 125 °C			100	
I _{IB}	Input bias current			1	20	pA
		-40 °C < T _{amb} < 125 °C			100	
I _{CC}	Supply current	No load, output high		0.47	0.69	mA
		No load, output high, -40 °C < T _{amb} < 125 °C			0.9	
		No load, output low		0.60	0.91	
		No load, output low, -40 °C < T _{amb} < 125 °C			1.1	
I _{SC}	Short circuit current	Source	58	62		mA
		Sink	58	64		
V _{OH}	Output voltage high	I _{source} = 4 mA	4.84	4.89		V
		-40 °C < T _{amb} < 125 °C	4.80			
V _{OL}	Output voltage low	I _{sink} = 4 mA		90	120	mV
		-40 °C < T _{amb} < 125 °C			180	
CMRR	Common-mode rejection ratio	0 < V _{ICM} < 2.7 V	57	74		dB
SVR	Supply voltage rejection	ΔV _{CC} = 2.2 V to 5 V		79		
T _{PLH}	Propagation delay, low to high output level ⁽⁴⁾	C _L = 12 pF, R _L = 1 MΩ, overdrive = 5 mV		14		ns
		C _L = 12 pF, R _L = 1 MΩ, overdrive = 15 mV		10		
		C _L = 12 pF, R _L = 1 MΩ, overdrive = 50 mV		8	11	
T _{PHL}	Propagation delay, high to low output level ⁽⁵⁾	C _L = 12 pF, R _L = 1 MΩ, overdrive = 5 mV		16		ns
		C _L = 12 pF, R _L = 1 MΩ, overdrive = 15 mV		11		
		C _L = 12 pF, R _L = 1 MΩ, overdrive = 50 mV		9	12	
T _R	Rise time (10 % to 90 %)	C _L = 12 pF, R _L = 1 MΩ, overdrive = 100 mV		1.1		ns
T _F	Fall time (90 % to 10 %)	C _L = 12 pF, R _L = 1 MΩ, overdrive = 100 mV		1.0		

Notes:

⁽¹⁾The offset is defined as the average value of positive (V_{TRIP+}) and negative (V_{TRIP-}) trip points (input voltage differences) requested to change the output state in each direction.

⁽²⁾Hysteresis is a built-in feature of the TS3011. It is defined as the voltage difference between the trip points.

⁽³⁾Maximum values include unavoidable inaccuracies of the industrial tests.

⁽⁴⁾Overdrive is measured with reference to the V_{TRIP+} point.

⁽⁵⁾Overdrive is measured with reference to the V_{TRIP-} point.

4 Electrical characteristic curves

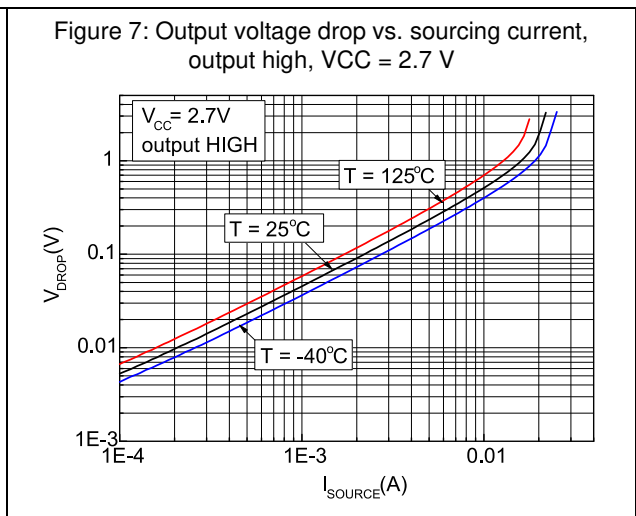
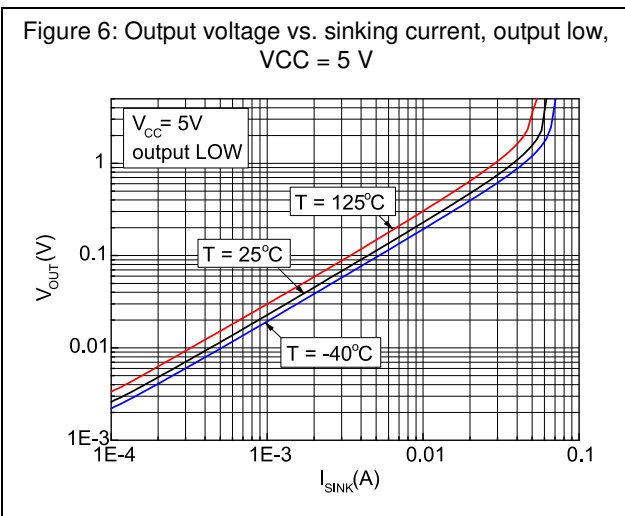
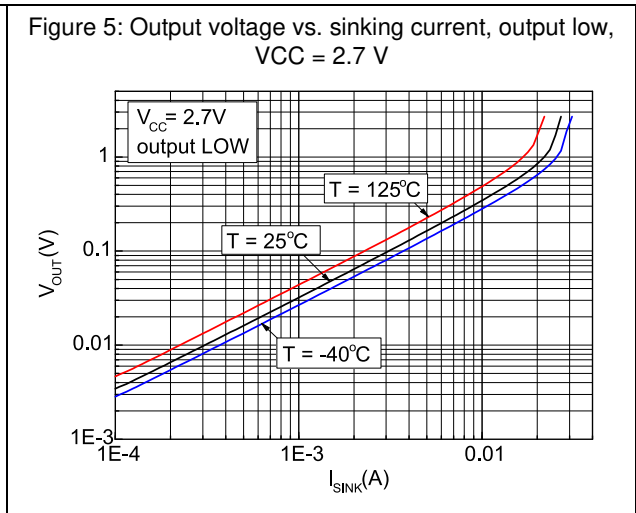
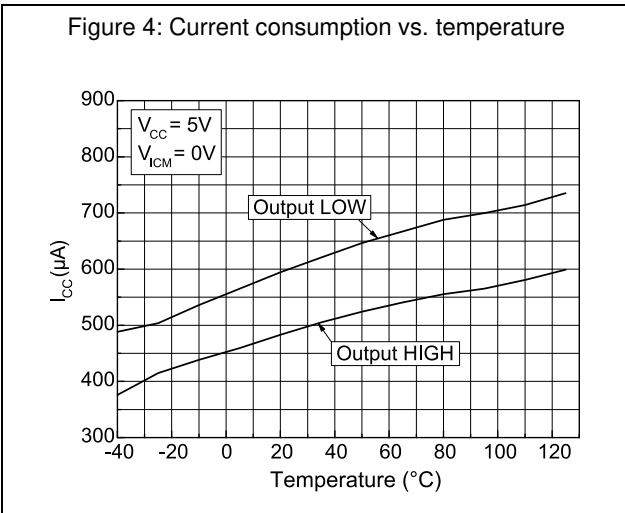
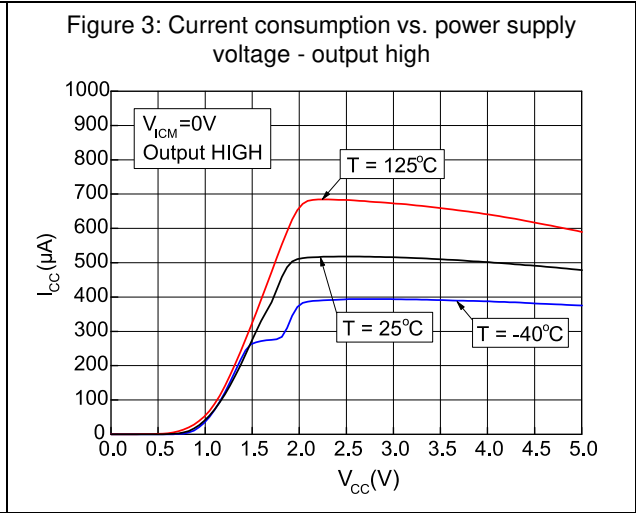
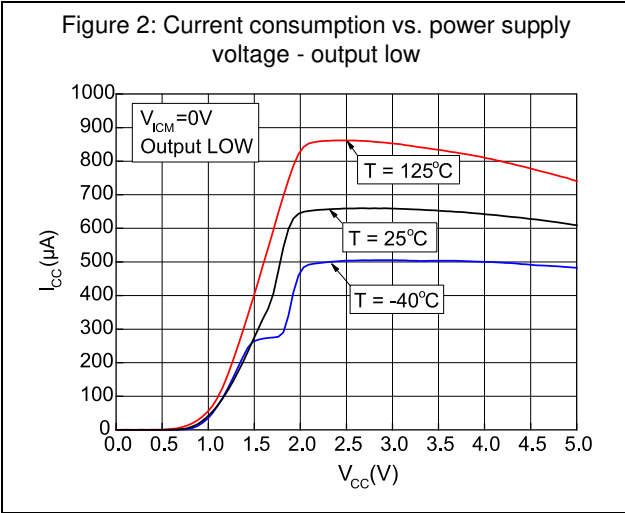

Figure 8: Output voltage drop vs. sourcing current, output high, VCC = 5 V

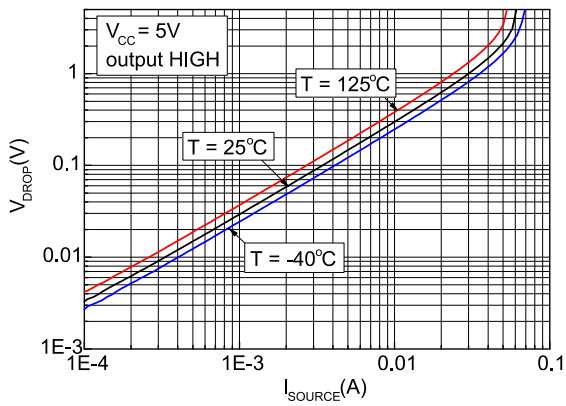

Figure 9: Input offset voltage vs. common mode voltage

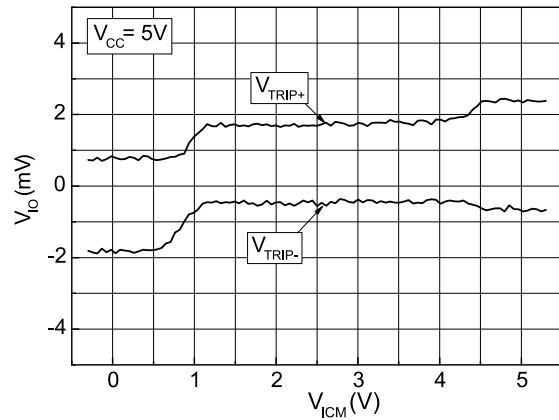

Figure 10: Input offset voltage vs. temperature

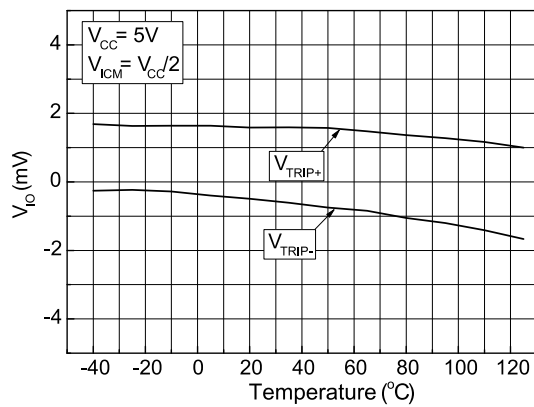

Figure 11: Propagation delay vs. common mode voltage with negative transition

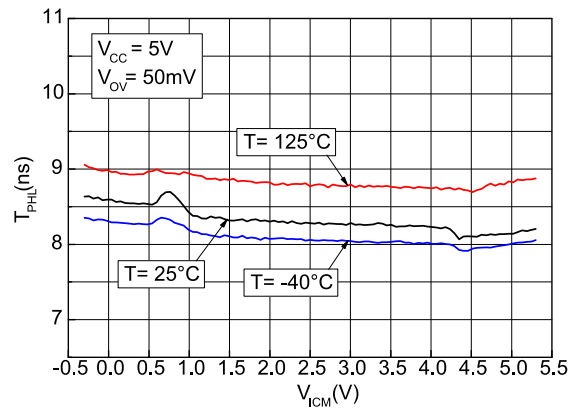

Figure 12: Propagation delay vs. common mode voltage with positive transition

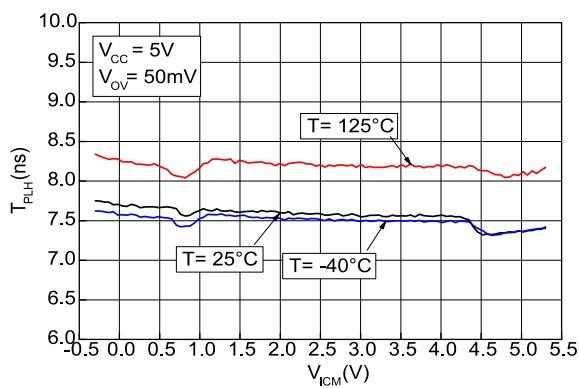

Figure 13: Propagation delay vs. power supply voltage with negative transition

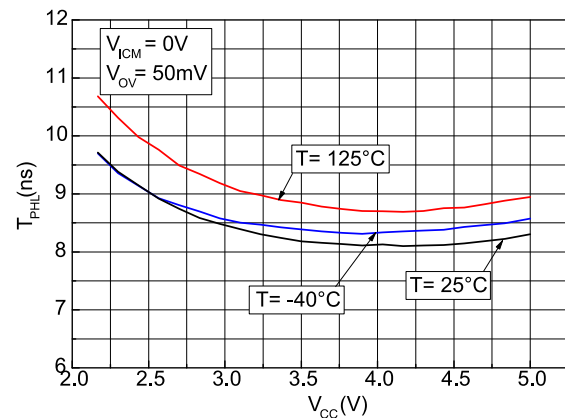

Figure 14: Propagation delay vs. power supply voltage with positive transition

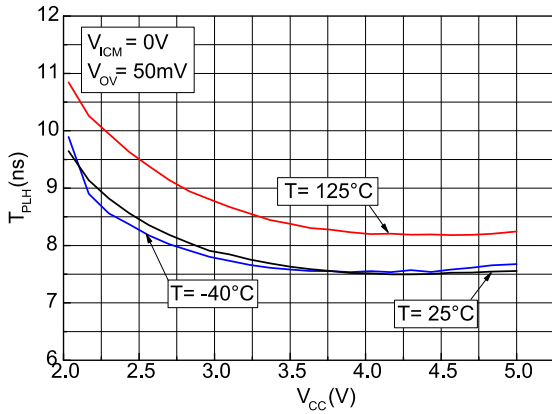

Figure 15: Propagation delay vs. overdrive with negative transition, $V_{CC} = 2.7\text{V}$

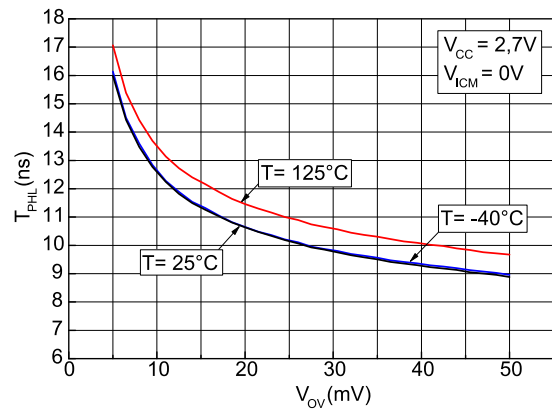

Figure 16: Propagation delay vs. overdrive with positive transition, $V_{CC} = 2.7\text{V}$

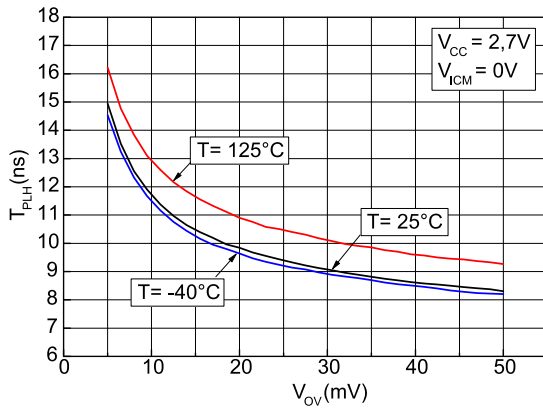

Figure 17: Propagation delay vs. overdrive with negative transition, $V_{CC} = 5\text{V}$

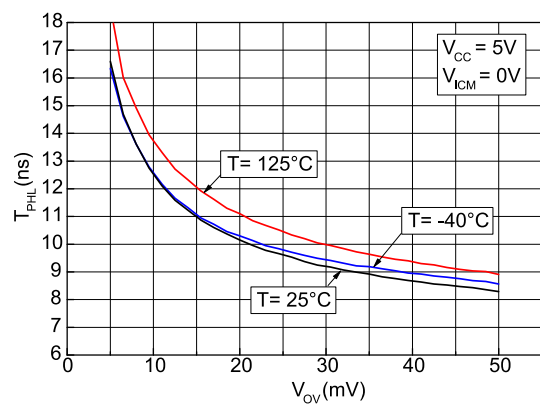

Figure 18: Propagation delay vs. overdrive with positive transition, $V_{CC} = 5\text{V}$

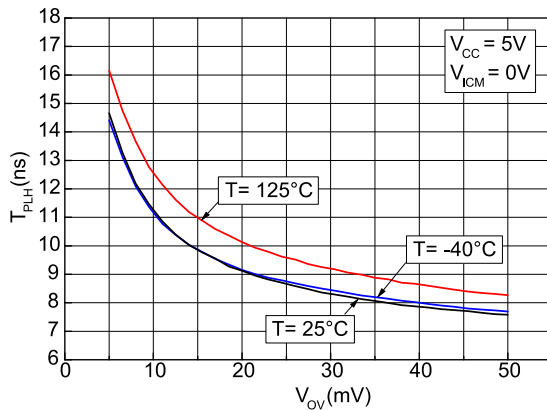
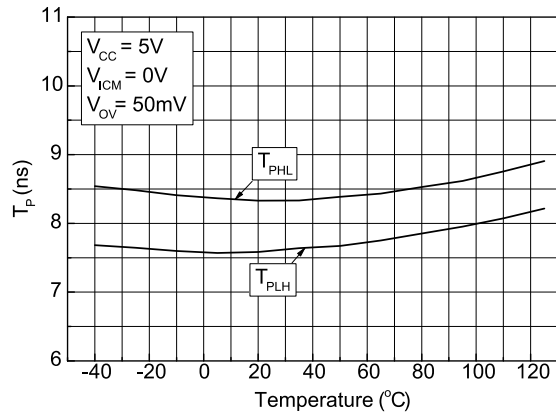

Figure 19: Propagation delay vs. temperature



5 Package information

In order to meet environmental requirements, ST offers these devices in different grades of ECOPACK® packages, depending on their level of environmental compliance. ECOPACK® specifications, grade definitions and product status are available at: www.st.com. ECOPACK® is an ST trademark.

5.1 SOT23-5 package information

Figure 20: SOT23-5 package outline

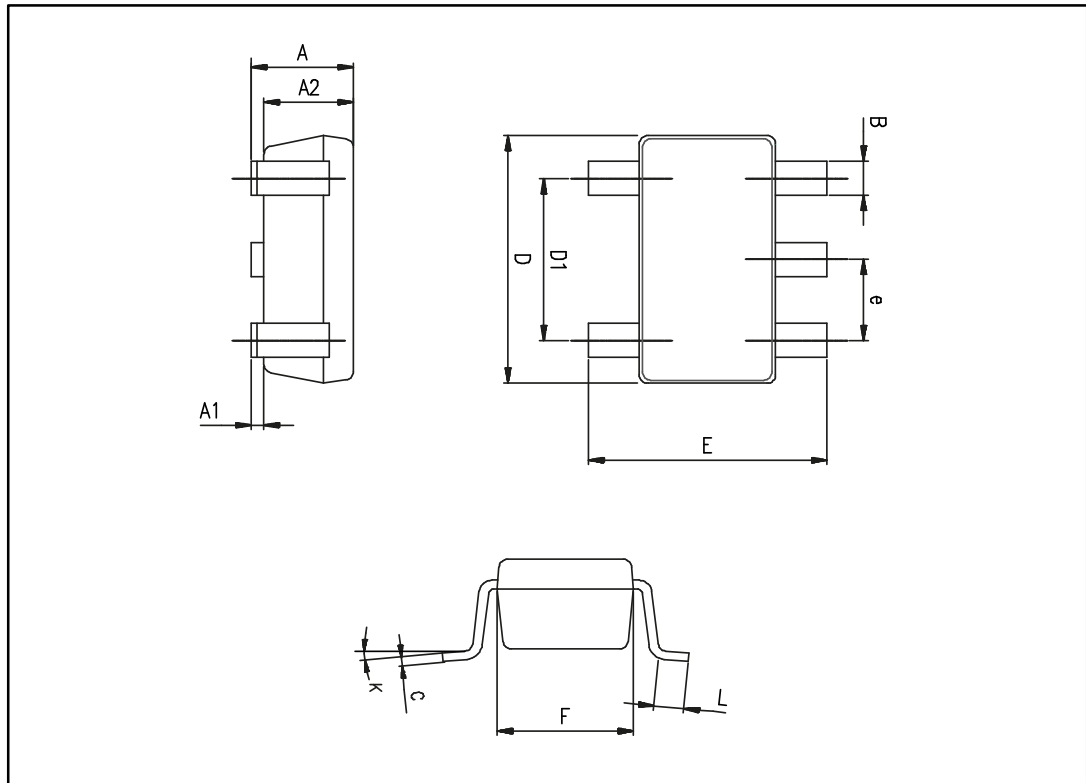

Table 6: SOT23-5 mechanical data

Ref.	Dimensions					
	Millimeters			Inches		
	Min.	Typ.	Max.	Min.	Typ.	Max.
A	0.90	1.20	1.45	0.035	0.047	0.057
A1			0.15			0.006
A2	0.90	1.05	1.30	0.035	0.041	0.051
B	0.35	0.40	0.50	0.014	0.016	0.020
C	0.09	0.15	0.20	0.004	0.006	0.008
D	2.80	2.90	3.00	0.110	0.114	0.118
D1		1.90			0.075	
e		0.95			0.037	
E	2.60	2.80	3.00	0.102	0.110	0.118
F	1.50	1.60	1.75	0.059	0.063	0.069
L	0.10	0.35	0.60	0.004	0.014	0.024
K	0 degrees		10 degrees	0 degrees		10 degrees

5.2 SC70-5 (or SOT323-5) package information

Figure 21: SC70-5 (or SOT323-5) package outline

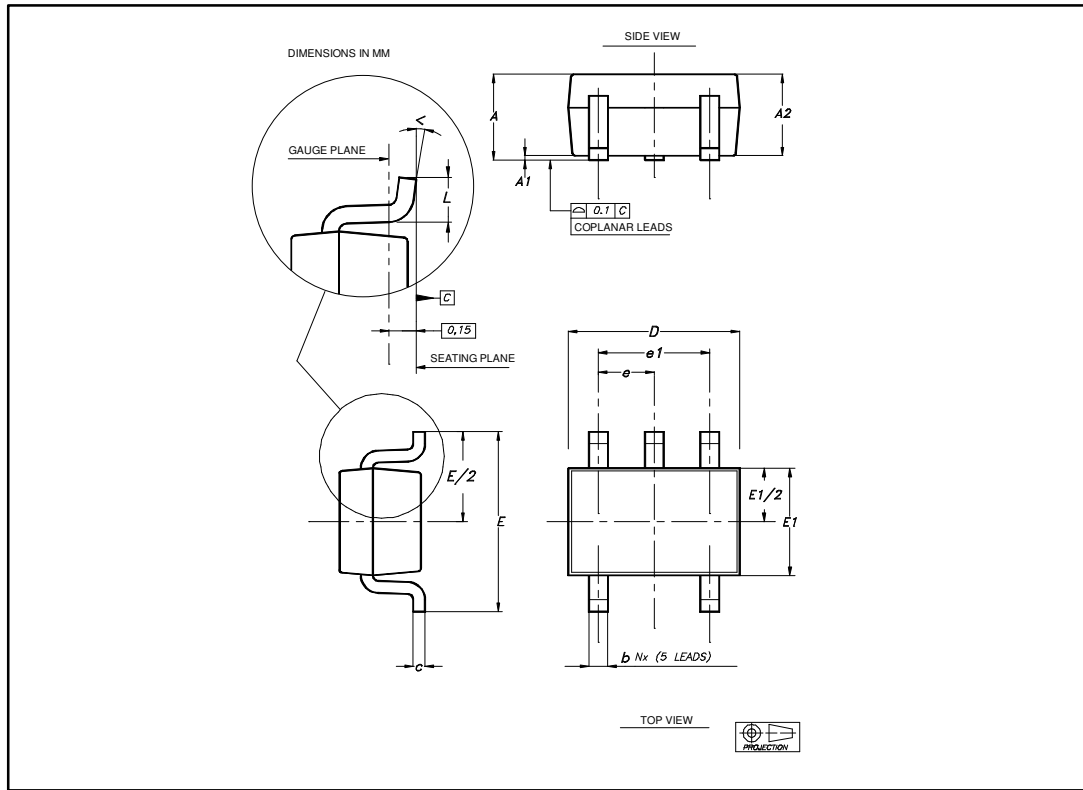

Table 7: SC70-5 (or SOT323-5) mechanical data

Ref.	Dimensions					
	Millimeters			Inches		
	Min.	Typ.	Max.	Min.	Typ.	Max.
A	0.80		1.10	0.032		0.043
A1			0.10			0.004
A2	0.80	0.90	1.00	0.032	0.035	0.039
b	0.15		0.30	0.006		0.012
c	0.10		0.22	0.004		0.009
D	1.80	2.00	2.20	0.071	0.079	0.087
E	1.80	2.10	2.40	0.071	0.083	0.094
E1	1.15	1.25	1.35	0.045	0.049	0.053
e		0.65			0.025	
e1		1.30			0.051	
L	0.26	0.36	0.46	0.010	0.014	0.018
<	0°		8°	0°		8°

6 Ordering information

Table 8: Order codes

Part number	Temperature range	Package	Packaging	Marking
TS3011ILT	-40 °C to 125 °C	SOT23-5	Tape and reel	K540
TS3011IYLT ⁽¹⁾				K541
TS3011ICT		SC70-5		K54

Notes:

⁽¹⁾ Qualified and characterized according to AEC Q100 and Q003 or equivalent, advanced screening according to AEC Q001 and Q 002 or equivalent.

7 Revision history

Table 9: Document revision history

Date	Revision	Changes
03-Oct-2011	1	Initial release.
18-Feb-2014	2	Updated Table 8: Order codes to add the order code TS3011IYLT. Added: Automotive qualification among the Features in the cover page.
27-May-2016	3	Updated document layout <i>Section 3: "Electrical characteristics"</i> : updated unit of "Input offset voltage drift" parameter to $\mu\text{V}/^\circ\text{C}$ (not $\text{mV}/^\circ\text{C}$). <i>Section 4: "Electrical characteristic curves"</i> : X-axes changed to mV (not V) in figures 15, 16, 17, and 18. <i>Table 6</i> : added "K" values for inches <i>Table 7</i> : updated A and A2 min values for inches and added "<" values for inches.

IMPORTANT NOTICE – PLEASE READ CAREFULLY

STMicroelectronics NV and its subsidiaries ("ST") reserve the right to make changes, corrections, enhancements, modifications, and improvements to ST products and/or to this document at any time without notice. Purchasers should obtain the latest relevant information on ST products before placing orders. ST products are sold pursuant to ST's terms and conditions of sale in place at the time of order acknowledgement.

Purchasers are solely responsible for the choice, selection, and use of ST products and ST assumes no liability for application assistance or the design of Purchasers' products.

No license, express or implied, to any intellectual property right is granted by ST herein.

Resale of ST products with provisions different from the information set forth herein shall void any warranty granted by ST for such product.

ST and the ST logo are trademarks of ST. All other product or service names are the property of their respective owners.

Information in this document supersedes and replaces information previously supplied in any prior versions of this document.

© 2016 STMicroelectronics – All rights reserved