



Chipsmall Limited consists of a professional team with an average of over 10 year of expertise in the distribution of electronic components. Based in Hongkong, we have already established firm and mutual-benefit business relationships with customers from,Europe,America and south Asia,supplying obsolete and hard-to-find components to meet their specific needs.

With the principle of "Quality Parts,Customers Priority,Honest Operation,and Considerate Service",our business mainly focus on the distribution of electronic components. Line cards we deal with include Microchip,ALPS,ROHM,Xilinx,Pulse,ON,Everlight and Freescale. Main products comprise IC,Modules,Potentiometer,IC Socket,Relay,Connector.Our parts cover such applications as commercial,industrial, and automotives areas.

We are looking forward to setting up business relationship with you and hope to provide you with the best service and solution. Let us make a better world for our industry!



Contact us

Tel: +86-755-8981 8866 Fax: +86-755-8427 6832

Email & Skype: info@chipsmall.com Web: www.chipsmall.com

Address: A1208, Overseas Decoration Building, #122 Zhenhua RD., Futian, Shenzhen, China



0.6-3V_{IN}, 1.8-3.6V_{OUT}, 3.5μA, High-Efficiency Boost + Output Load Switch

FEATURES

- ◆ Combines Low-power Boost + Output Load Switch
- ◆ Boost Regulator
 - Input Voltage: 0.6V- 3V
 - Output Voltage: 1.8V- 3.6V
 - Efficiency: Up to 84%
 - No-load Input Current: 3.5μA
 - Delivers >100mA at 1.8V_{BO} from 1.2V_{BI}
 - Boost Shutdown Control
 - No External Schottky Diode Required
- ◆ Anti-Crush Capability
 - Prevents Input Voltage Collapse when powered with Weak/High Impedance Power Sources
- ◆ Single-Inductor, Discontinuous Conduction Mode Scheme with Automatic Peak Current Adjustment
- ◆ 16-Pin, Low-Profile, Thermally-Enhanced 3mm x 3mm TQFN Package

APPLICATIONS

Coin Cell-Powered Portable Equipment
 Single Cell Li-ion or Alkaline Powered Equipment
 Solar or Mechanical Energy Harvesting
 Wireless Microphones
 Wireless Remote Sensors
 RFID Tags
 Blood Glucose Meters
 Personal Health-Monitoring Devices

DESCRIPTION

The TS3300 is a 1st-generation power management product that combines a high-efficiency boost regulator and an output load switch in one package. The boost regulator operates from a supply voltage as low as 0.6V and can deliver at least 75mA at 1.2V_{BI} to 3V_{BO}, an industry first.

The TS3300 includes an *anti-crush*TM feature to prevent the collapse of the input voltage to the boost regulator when the input is a weak (high impedance) source. If the input voltage drops below a determined voltage threshold (settable by a resistor divider), the boost regulator switching cycles are paused, effectively limiting the minimum input voltage. *Anti-crush*TM is useful in applications where a buffer capacitor at the boost's output can service burst loads, and the input source exhibits substantial source impedance (such as an old battery, or at cold temperatures).

The TS3300 is fully specified over the -40°C to +85°C temperature range and is available in a low-profile, thermally-enhanced 16-pin 3x3mm TQFN package with an exposed back-side paddle. For best performance, solder the exposed back-side paddle to PCB ground.

TYPICAL APPLICATION CIRCUIT

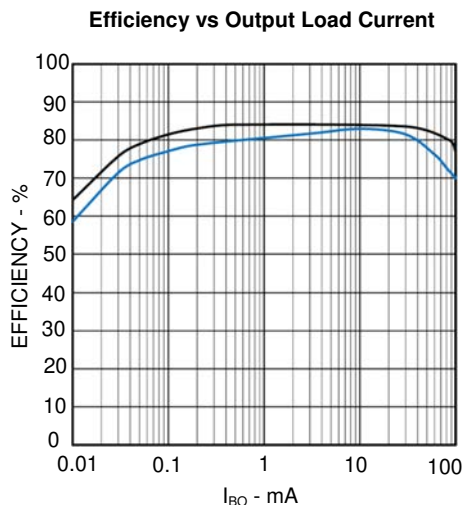
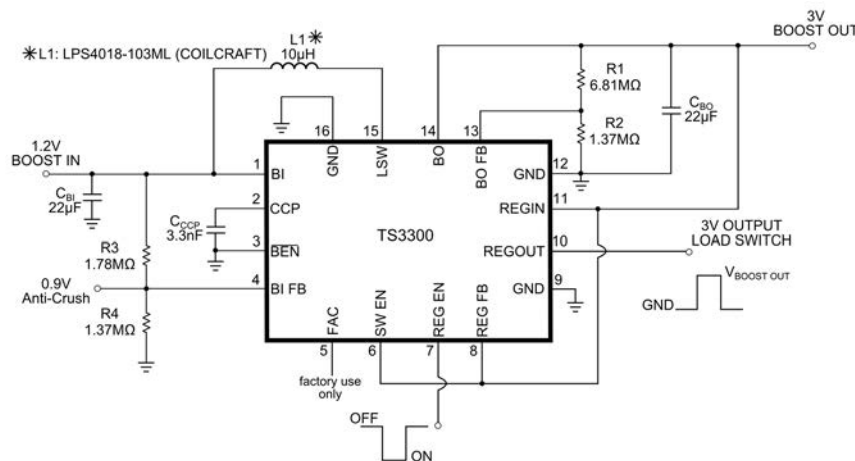

ABSOLUTE MAXIMUM RATINGS

BI to GND -0.3V to $V_{BO} + 0.1V$
 CCP -0.3V to +2.5V
 \overline{BEN} to GND -0.3V to $V_{BI} + 0.3V$
 BI FB, BO FB to GND -0.3V to $V_{BO} + 0.3V$
 SW EN, REG EN, REG FB, REG OUT to GND -0.3V to $V_{REGIN} + 0.3V$
 BO, REG IN to GND -0.3V to +5.75V
 LSW to GND -0.3V to +5.75V

Continuous Power Dissipation ($T_A = +70^\circ C$)
 16-Pin TQFN (Derate at 17.5mW/ $^\circ C$ above +70 $^\circ C$) 1398mW
 Operating Temperature Range -40 $^\circ C$ to +85 $^\circ C$
 Storage Temperature Range -65 $^\circ C$ to +150 $^\circ C$
 Lead Temperature (Soldering, 10s) +300 $^\circ C$

Electrical and thermal stresses beyond those listed under “Absolute Maximum Ratings” may cause permanent damage to the device. These are stress ratings only and functional operation of the device at these or any other condition beyond those indicated in the operational sections of the specifications is not implied. Exposure to any absolute maximum rating conditions for extended periods may affect device reliability and lifetime.

PACKAGE/ORDERING INFORMATION

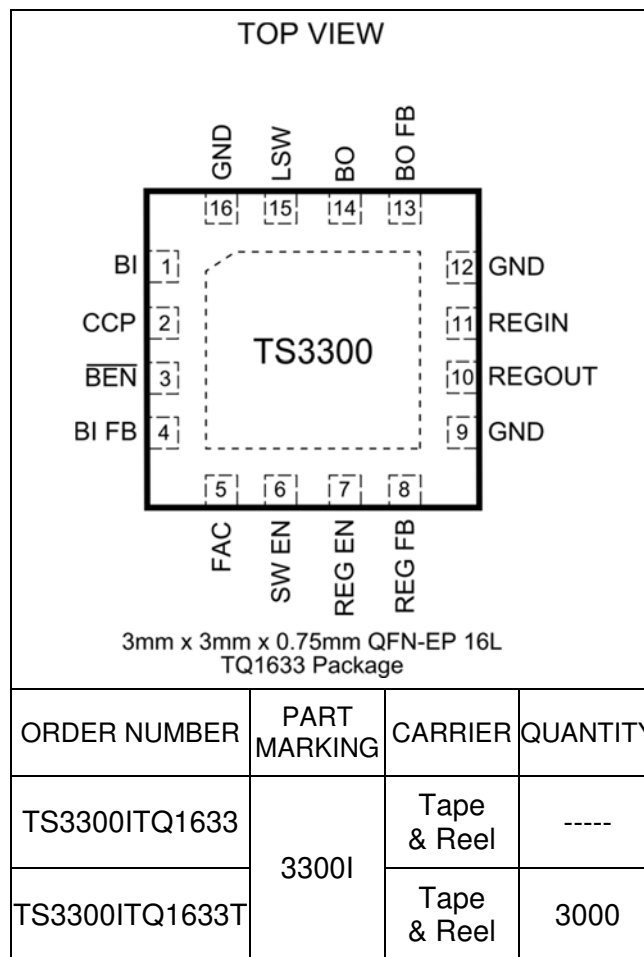

Lead-free Program: Silicon Labs supplies only lead-free packaging.

Consult Silicon Labs for products specified with wider operating temperature ranges.

ELECTRICAL CHARACTERISTICS

$V_{BI} = 1.2V$, $V_{BO} = 3V$, $V_{BEN} = GND$, $I_{BO} = 20mA$, $L = 10\mu H$, $C_{BI} = C_{BO} = 22\mu F$ unless otherwise noted. Values are at $T_A = -40^\circ C$ to $+85^\circ C$ unless otherwise specified. Typical values are at $T_A = +25^\circ C$ unless otherwise specified. Please see Note 1.

PARAMETER	SYMBOL	CONDITIONS	MIN	TYP	MAX	UNITS
Minimum Input Boost Voltage	V_{BI_MIN}	$I_{BO} = 0mA$, $T_A = 25^\circ C$		0.6	0.75	V
Maximum Input Boost Voltage	V_{BI_MAX}	Guaranteed by design	3			V
Output Boost Voltage Range	V_{BO}		1.8		3.6	V
No-Load Input Current	I_Q	See Note 2.	@ BO	3.5		μA
			@ BI	0.07		
		$-40^\circ C < T_A < +85^\circ C$	@ BO		6	
		See Note 2.	@ BI		0.9	
		Active-Mode See Note 3.	@ BI	10.8		
Output Load-Switch Supply Current	I_{REGIN}	$I_{REGOUT} = 0mA$, $V_{REGEN} = V_{REGIN}$		0.4	1	μA
Boost Shutdown Supply Current	$I_{SHUTDOWN}$	$V_{BEN} = V_{BI}$ $T_A = 25^\circ C$			100	nA
Boost Feedback Voltage during operation	V_{BO_FB}	Output voltage accuracy: $\pm 4\%$	0.489	0.505	0.521	V
Anti-Crush Feedback Voltage	V_{BI_FB}	$V_{BI} \geq 0.6V$	0.363	0.392	0.425	V
Anti-Crush Feedback Voltage Hysteresis	$V_{BI_FB_HYST}$			50		mV
Inductor Peak Current	I_{PK}	$I_{BO} = 0mA$	365			mA
Inductor Valley Current	I_V			10		mA
On Resistance	NMOS	R_{ON} NMOS		0.27		Ω
	PMOS	R_{ON} PMOS		0.48		
	LOAD SWITCH	R_{ON} LOAD SWITCH	Measured from REGIN to REGOUT. See Note 4.	0.9	1.2	
Boost Enable Threshold	V_{BEN}	V_{IL}			0.2	V
		V_{IH}	$V_{BI} - 0.05$			V
Boost Enable Hysteresis	V_{BEN_HYST}			200		mV
Output Load Switch Enable Threshold	V_{REGEN}	V_{IL} (CMOS logic)			$0.2 \times V_{REGIN}$	V
		V_{IH} (CMOS logic)	$0.8 \times V_{REGIN}$			
Output Load Switch Enable Hysteresis	V_{REGEN_HYST}			100		mV
BO FB Input Leakage Current	I_{BO_FB}			± 0.1	± 1	nA
REGEN Input Leakage Current	I_{REGEN}				10	
REGFB Input Leakage Current	I_{REGFB}			± 0.1	± 1	

Note 1: All devices are 100% production tested at $T_A = +25^\circ C$ and are guaranteed by characterization for $T_A = -40^\circ C$ to $+85^\circ C$, as specified.

Note 2: $I_{BO} = 0mA$, $V_{BO_FB} = 0.6V$.

Note 3: Boost Only Circuit configuration. $I_{BO} = 0mA$. $V_{BI_FB} = V_{BI}$. $V_{BI} = 1.2V$. $V_{BO} = 3V$.

Note 4: $V_{SW_EN} = V_{REGIN} = V_{BO}$. $V_{REGEN} = GND$.

TYPICAL PERFORMANCE CHARACTERISTICS

$V_{BI} = 1.2V$, $V_{BO} = 3V$, $V_{BEN} = GND$, $I_{BO} = 0A$, $L = 10\mu H$ (LPS4018-103ML), $C_{BI} = C_{BO} = 22\mu F$, $V_{SW EN} = V_{REG FB} = V_{REG EN} = V_{REG IN} = V_{BO}$, $I_{REG OUT} = 0A$, unless otherwise specified. Values are at $T_A = 25^\circ C$ unless otherwise specified.

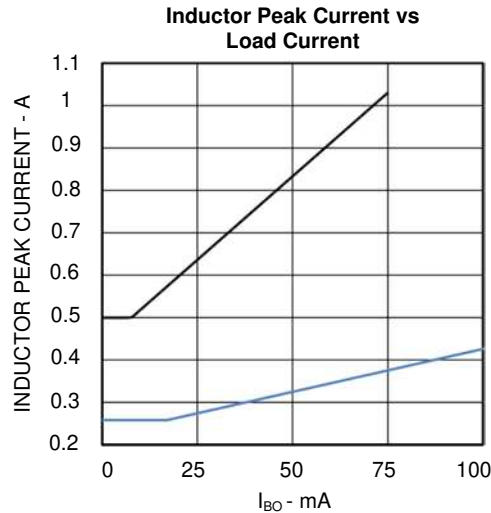
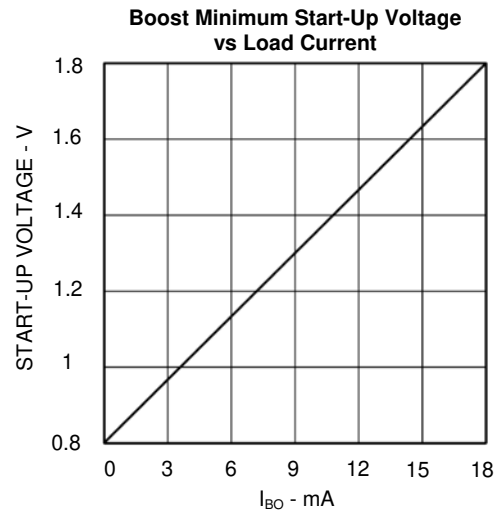
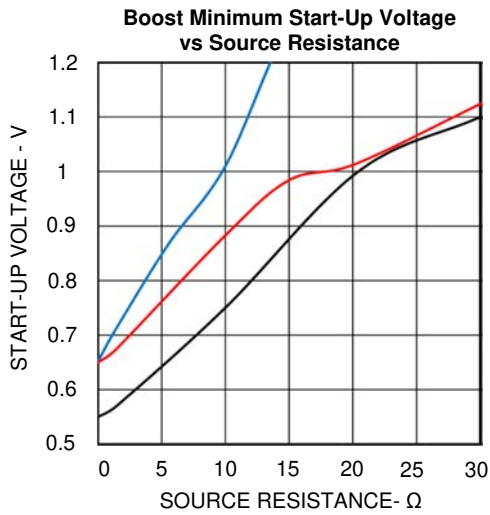
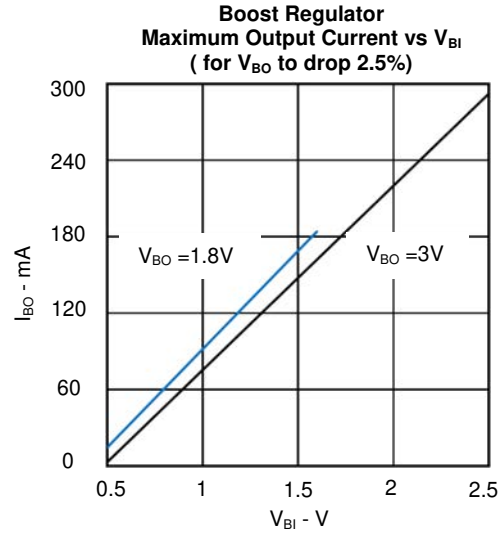
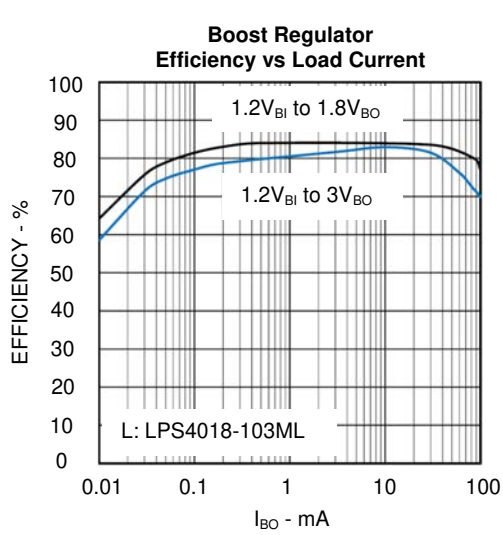



SILICON LABS

TYPICAL PERFORMANCE CHARACTERISTICS

$V_{BI} = 1.2V$, $V_{BO} = 3V$, $V_{BEN} = GND$, $I_{BO} = 0A$, $L = 10\mu H$ (LPS4018-103ML), $C_{BI} = C_{BO} = 22\mu F$, $V_{SW EN} = V_{REG FB} = V_{REG EN} = V_{REG IN} = V_{BO}$, $I_{REG OUT} = 0A$, unless otherwise specified. Values are at $T_A = 25^\circ C$ unless otherwise specified.

Boost Regulator Output Voltage Ripple
 $V_{BI} = 1.2V$, $V_{BO} = 1.8V$, $C_{BO} = 22\mu F$, $I_{BO} = 5mA$

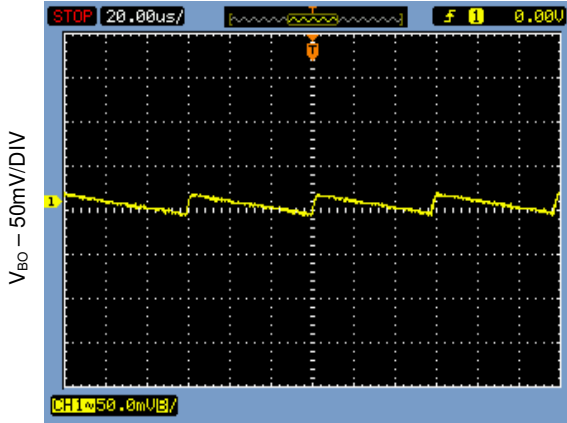

20µs/DIV

Boost Regulator Output Voltage Ripple
 $V_{BI} = 1.2V$, $V_{BO} = 1.8V$, $C_{BO} = 22\mu F$, $I_{BO} = 40mA$

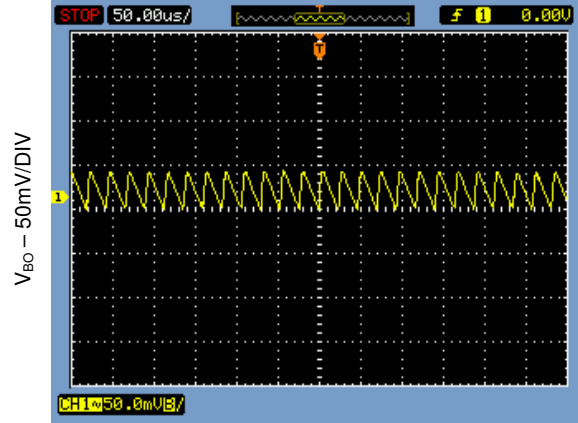

50µs/DIV

Boost Regulator Output Voltage Ripple
 $V_{BI} = 1.2V$, $V_{BO} = 1.8V$, $C_{BO} = 22\mu F$, $I_{BO} = 80mA$

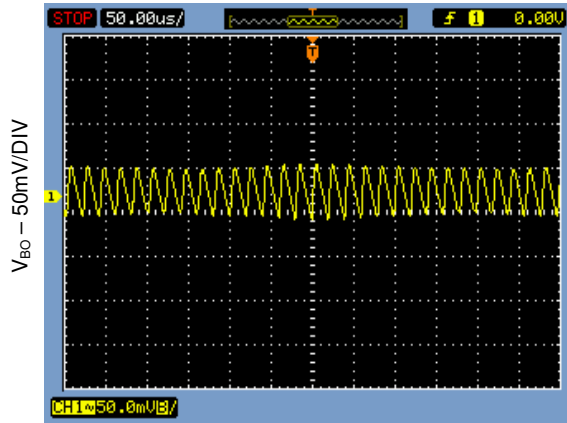

50µs/DIV

Boost Regulator Output Voltage Ripple
 $V_{BI} = 1.2V$, $V_{BO} = 3V$, $C_{BO} = 22\mu F$, $I_{BO} = 5mA$

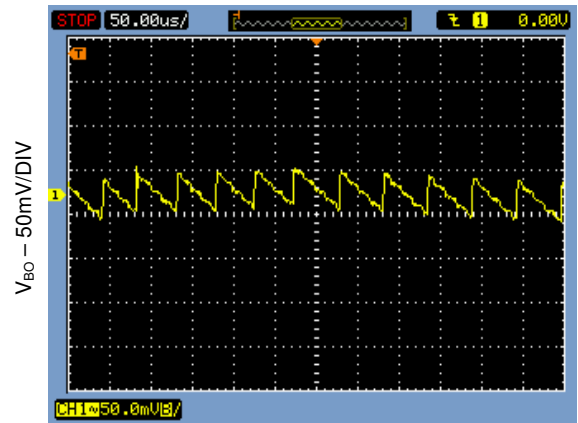

50µs/DIV

Boost Regulator Output Voltage Ripple
 $V_{BI} = 1.2V$, $V_{BO} = 3V$, $C_{BO} = 22\mu F$, $I_{BO} = 80mA$

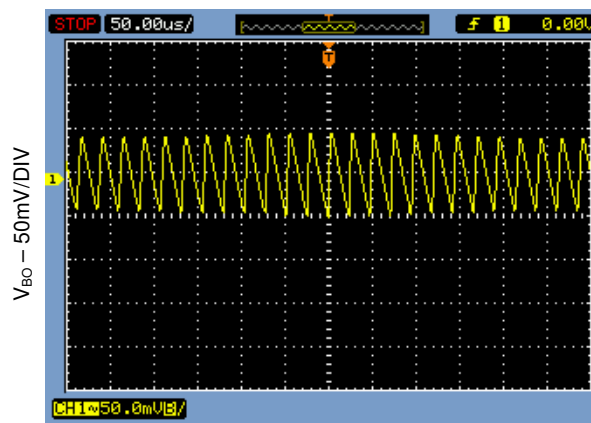

50µs/DIV

TYPICAL PERFORMANCE CHARACTERISTICS

$V_{BI} = 1.2V$, $V_{BO} = 3V$, $V_{BEN} = GND$, $I_{BO} = 0A$, $L = 10\mu H$ (LPS4018-103ML), $C_{BI} = C_{BO} = 22\mu F$, $V_{SW EN} = V_{REG FB} = V_{REG EN} = V_{REG IN} = V_{BO}$, $I_{REG OUT} = 0A$, unless otherwise specified. Values are at $T_A = 25^\circ C$ unless otherwise specified.

Boost Regulator Load Step Response
 $V_{BI} = 1.2V$, $V_{BO} = 3V$, $C_{BO} = 10\mu F$, $I_{BO} = 40mA$

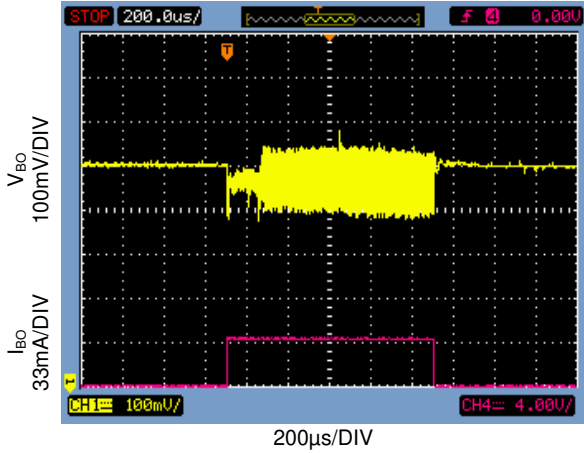

Boost Regulator Load Step Response
 $V_{BI} = 1.2V$, $V_{BO} = 3V$, $C_{BO} = 10\mu F$, $I_{BO} = 5mA$

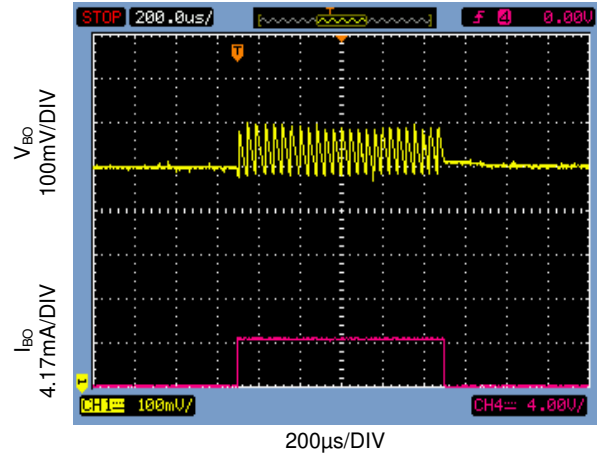

Boost Regulator Output Voltage Ripple, Inductor Current, and LSW Voltage
 $V_{BI} = 1.2V$, $V_{BO} = 3V$, $C_{BO} = 22\mu F$, $I_{BO} = 40mA$

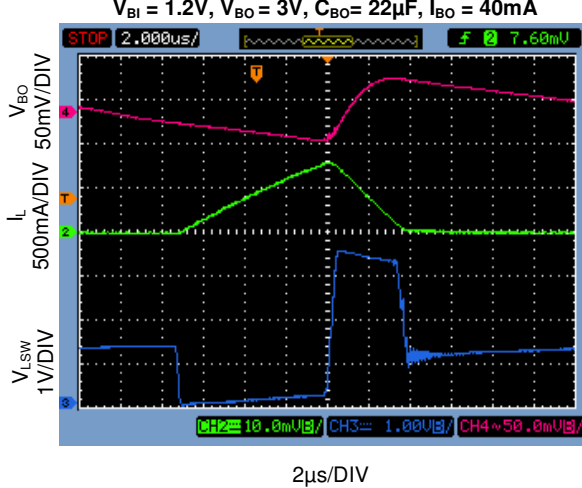

Boost Regulator Output Voltage Ripple, Inductor Current, and LSW Voltage
 $V_{BI} = 1.2V$, $V_{BO} = 1.8V$, $C_{BO} = 22\mu F$, $I_{BO} = 5mA$

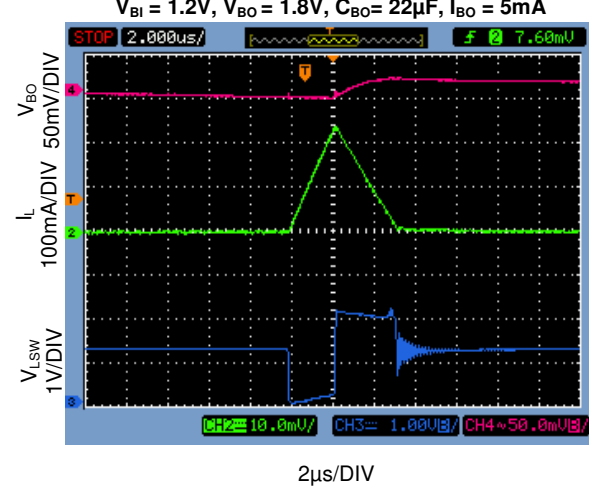

Large Output Capacitor Start-up with $V_{ANTI-CRUSH}^{TM} = 0.9V$
 $C_{BO} = 500\mu F$, $R_{IN} = 10\Omega$, $C_{IN} = 22\mu F$, $V_{BI} = 1.2V$

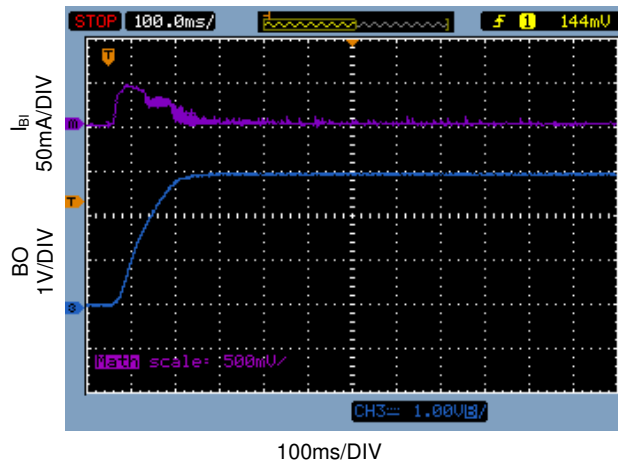

PIN FUNCTIONS

PIN	NAME	FUNCTION
1	BI	Boost Input. Connect to input source. C_{BI} Connection.
2	CCP	Place a 3.3nF capacitor between this pin and GND
3	\overline{BEN}	Boost Enable (active low). To enable the TS3300, connect this to GND. To disable the TS3300, set the voltage to greater than $V_{BI} - 50mV$.
4	BI FB	Boost Input Feedback for Anti-Crush Voltage Setting. The BI FB pin voltage is 392mV. To set the anti-crush voltage, refer to the <i>Applications Information</i> section and to Figure 4.
5	FAC	Factory use only. Do not connect to GND or VDD. Leave open.
6	SW EN	Connect to REGIN.
7	REG EN	Output Load-Switch Logic Input Control (active low).
8	REG FB	Connect to REGIN.
9	GND	Ground. Connect this pin to the analog ground plane.
10	REGOUT	Boost Regulator Load-Switch output.
11	REGIN	Boost Regulator Load-Switch input. Connect to BO for use.
12	GND	Ground. Connect this pin to the analog ground plane.
13	BO FB	Boost Output Feedback. The BO FB pin voltage is 505mV. BO FB coupled with a voltage divider circuit sets the boost regulator output voltage. Refer to Figure 3.
14	BO	Regulated output voltage set by resistor network. To set regulated output voltage, refer to Figure 3. C_{BO} connection.
15	LSW	Inductor Connection.
16	GND	Ground. Connect this pin to the analog ground plane.
EP	-	For best electrical and thermal performance, connect exposed paddle to GND.

BLOCK DIAGRAM

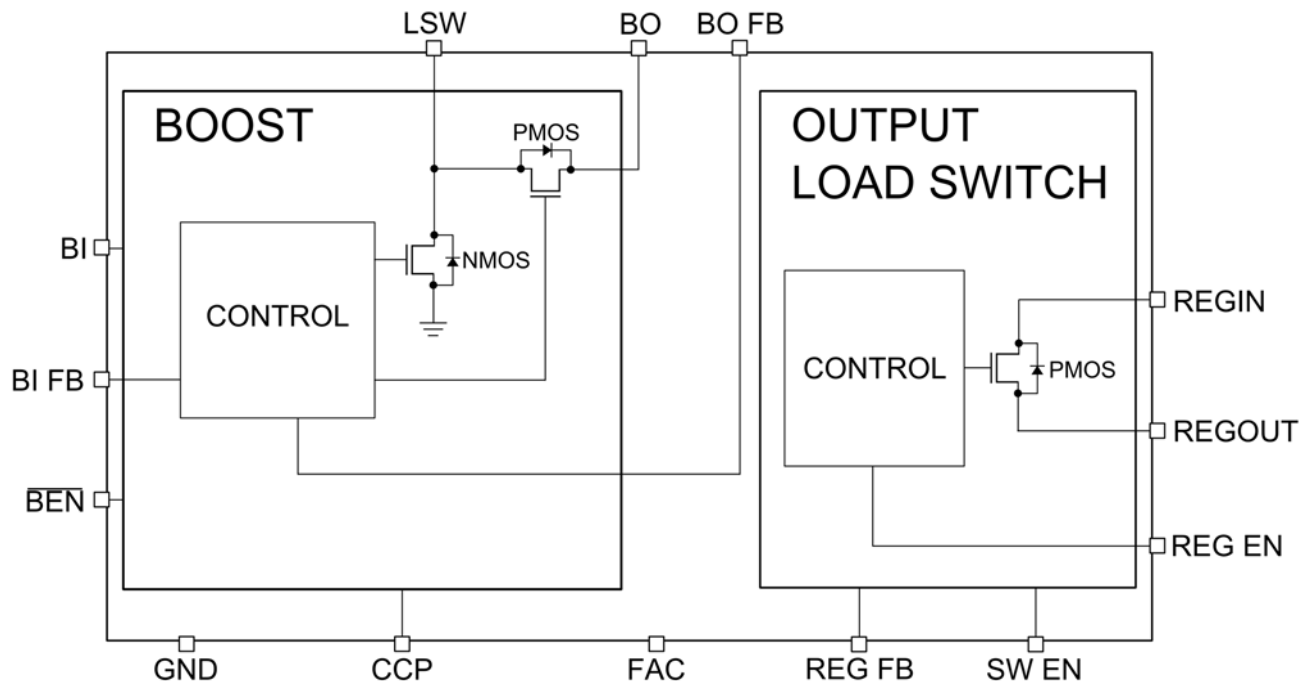

THEORY OF OPERATION

The TS3300 is a power management product that combines a high-efficiency boost regulator and an output load switch into one package. The boost regulator can operate from supply voltages as low as 0.6V and can deliver at least 75mA at 1.2V_{BI} and 3V_{BO}. Under no-load conditions, the boost regulator exhibits a No-Load Input Supply Current of 10.8µA that is actually drawn from the input source while the output is within regulation.

At start-up, an internal low voltage oscillator in the start-up control circuitry drives the gate of the internal FET to charge the load capacitor. Once the output voltage reaches approximately 1.1V, the main control circuitry starts to operate.

With an adjustable peak inductor current, the TS3300 can provide up to 84% efficiency with a 1.2V_{BI} and 3V_{BO}. The input and output supply voltage range for the boost regulator is from 0.6V to 3V and 1.8V to 3.6V, respectively.

The TS3300 can be operated in two different configurations, Boost Only Configuration or Boost + Output Load Switch Configuration. If the Output Load Switch is not needed, it is recommended to use the Boost Only Configuration, since the lowest quiescent current is achievable this way.

Boost + Output Load Switch Operation

For Boost + Output Load Switch operation, please refer to Figure 1 which displays the appropriate circuit configuration. The Boost's Output, BO, must be connected to the Output Load Switch Input, REGIN. The Output Load Switch is controlled by REGEN, which is an Active Low Logic Input. The SWEN and REGFB pins must be connected to REGIN. During Boost + Output Load Switch operation, the Boost Shutdown Control should not be used. The $\overline{\text{BEN}}$ pin should be connected to analog ground. During this mode of operation, the Output Load Switch will require an added 1µA of Input Supply Current as drawn from the input source. The anti-crush™ feature can be used during Boost + Output Load Switch operation. The output load switch should not be used as a load disconnect. Refer to Table 1 for the Output Load Switch settings.

OUTPUT LOAD SWITCH FUNCTION				
REG FB	SW EN	REGIN	REG EN	FUNCTION
REG FB, SW EN, REGIN should be connected to BO.			High	V _{REGOUT} =GND (OFF State)
			Low	V _{REGOUT} =V _{BO} (ON State)

Table 1. Output Load Switch settings

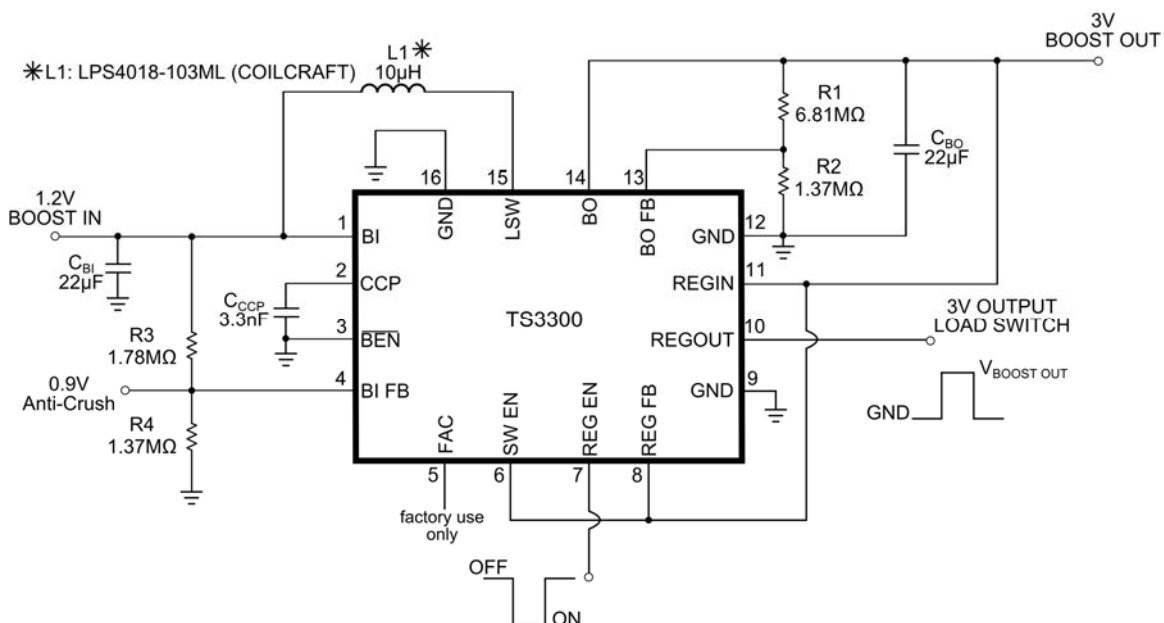

Figure 1. Boost + Output Load Switch Circuit Configuration

Boost Only Operation

For Boost Only operation, please refer to Figure 2 which displays the appropriate circuit configuration. The Anti-Crush feature can be used during Boost Only operation. During Boost Only operation, a shutdown (BEN) pin is available to shutdown the boost regulator. The boost regulator is in shutdown mode when $\overline{\text{BEN}}$ is HIGH. During shutdown, the supply current reduces to 0.1 μA . For Boost Only operation, the following pins should be connected to analog ground, REGIN, REGOUT, REGFB, REGEN, and SWEN.

How to Set the Boost Output Voltage

The output voltage can be set via a voltage divider circuit as shown in Figure 3. The output feedback (BO FB) pin is 505mV. It is recommended to use large resistor values to minimize additional current draw at the output. Resistor values less than 8M Ω are recommended.

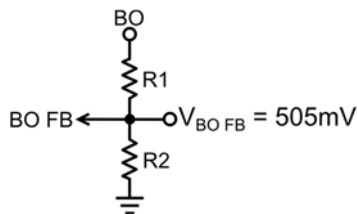

Figure 3. Setting the Boost Output Voltage with a Voltage Divider

Using the following equation to solve for R1 for a given R2 value, the output voltage can be set:

$$R1 = \frac{(V_{BO} - 0.505)R2}{0.505}$$

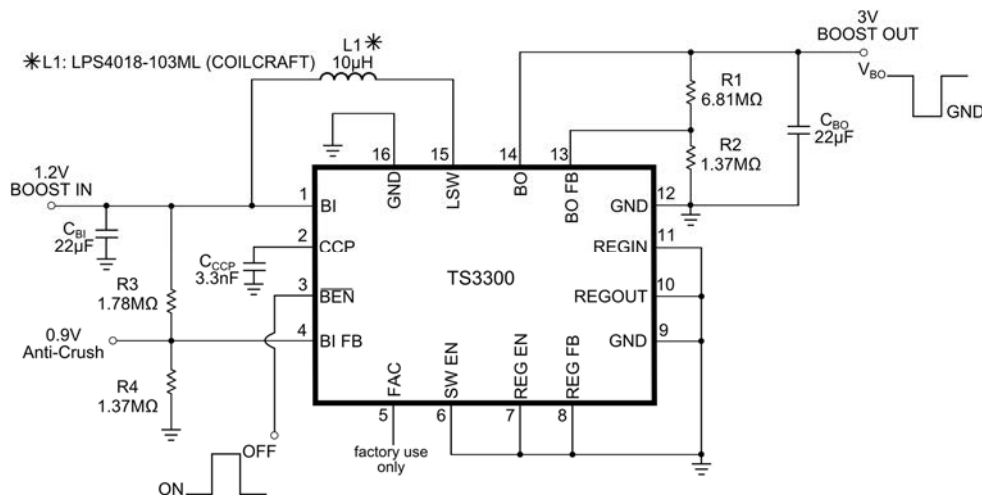

Figure 2. Boost Only Circuit Configuration

To set a 3V output voltage with $R2 = 1.37\text{M}\Omega$, $R1$ is calculated to be 6.77M Ω . A 1% standard resistor value of 6.81M Ω can be selected. This results in an output voltage of 3.02V.

APPLICATIONS INFORMATION

Inductor Selection

A low ESR, shielded 10 μH inductor is recommended for most applications and provides the best compromise between efficiency and size. A low loss ferrite and low dc resistance (DCR) inductor is best for optimal efficiency. Furthermore, there should exist at least an 8% margin between the saturation current of the inductor and the peak inductor current for a given set of operating conditions. Table 2 provides a list of inductor manufactures. Refer to the Inductor Peak Current vs Load Current plot in the “Typical Performance Characteristics” section. This plot shows how the inductor peak current varies with load current with a LPS4018-103ML inductor from Coilcraft.

Inductors	
Supplier	Website
Coilcraft	www.coilcraft.com
Murata	www.murata.com
Sumida	www.sumida.com

Table 2. Inductor Manufactures

Input and Output Capacitor Selection

For the boost regulator, a low ESR ceramic input and output capacitor of at least 10 μF is recommended to be placed as close as possible to the BI and BO pin. Output voltage ripple can be reduced by increasing the value of the output capacitor while providing improved transient response. Ceramic capacitors with X5R or X7R dielectric with a minimum voltage rating of 10V are recommended.

Boost Input Anti-Crush™ Feature

The TS3300 includes an *anti-crush™* feature to prevent the collapse of the input voltage to the boost regulator when the input is a weak (high impedance) source. If the input voltage drops below a determined voltage threshold (settable by a resistor divider), the boost regulator switching cycles are paused, effectively limiting the minimum input voltage. *Anti-crush™* is useful in applications where a buffer capacitor at the boost's output can service burst loads, and the input source exhibits substantial source impedance (such as with an old battery, or at cold temperatures).

To set the anti-crush™ voltage, a feedback pin (BI FB) in conjunction with a voltage divider circuit can be implemented as shown in Figure 4. The feedback pin voltage is 392mV. It is recommended to use large resistor values to minimize additional current draw at the input.

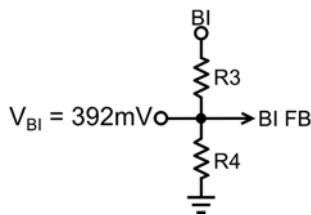

Figure 4. Setting the Anti-Crush™ Voltage with a Voltage Divider

Using the following equation to solve for R5 for a given R6 value, the output voltage can be set:

$$R3 = \frac{(V_{ANTI-CRUSH} - 0.392)R4}{0.392}$$

To set a 0.9V $V_{ANTI-CRUSH}$ voltage with $R4 = 1.37M\Omega$, $R3$ is calculated to be $1.78M\Omega$. The anti-crush™ voltage is to be set above the minimum input voltage specification of the TS3300.

Figure 5 shows a scope capture of the load step response. The measurement was performed with the anti-crush™ voltage set to 0.9V. The output of the Boost Regulator is pulsed with a 100mA load every 100ms for 1ms as shown by the pink curve, the input voltage after a battery impedance of 10Ω drops from 1.2V to 0.9V as shown by the blue curve and the boost output voltage drops by only 160mV as shown by the yellow curve. The TS3300 quickly replenishes the $500\mu F$ capacitor and the output of the boost regulator returns to 3V.

Boost Load Step Response with $V_{Anti-Crush} = 0.9V$
 $R_{IN} = 10\Omega$, $V_{BI} = 1.2V$, $V_{BO} = 3V$, $C_{BO} = 500\mu F$, $I_{BO} = 100mA$

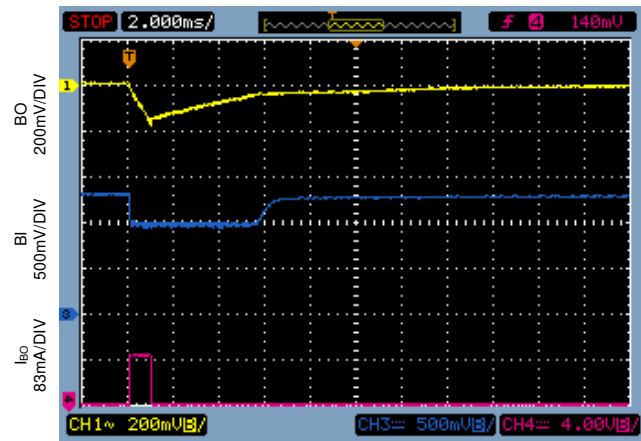

Figure 5. Using Anti-Crush™ Feature to Maintain Output Regulation with Load Step Response

Figure 6 shows a scope capture of the anti-crush™ feature in action at start-up under a heavy capacitive load of $500\mu F$ and an input source impedance of 10Ω . A high source impedance is typical of a weak battery source. The measurement was performed with the anti-crush™ voltage set to 0.9V. The purple and blue traces represent the input current and boost output voltage respectively. At start-up, the current rises up to 50mA and drops to approximately 30mA for approximately 40ms in order to charge the output capacitor. At this point, the voltage to the input of the TS3300 is 0.9V until the boost output achieves regulation.

Large Output Capacitor Start-up with $V_{Anti-Crush} = 0.9V$
 $R_{IN} = 10\Omega$, $V_{BI} = 1.2V$, $V_{BO} = 3V$, $C_{BO} = 500\mu F$

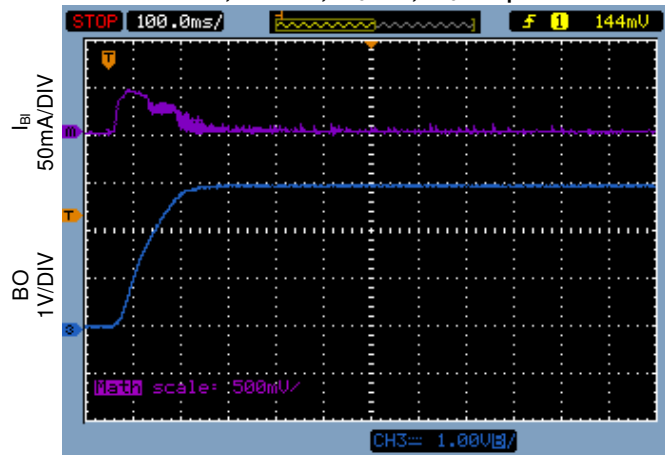
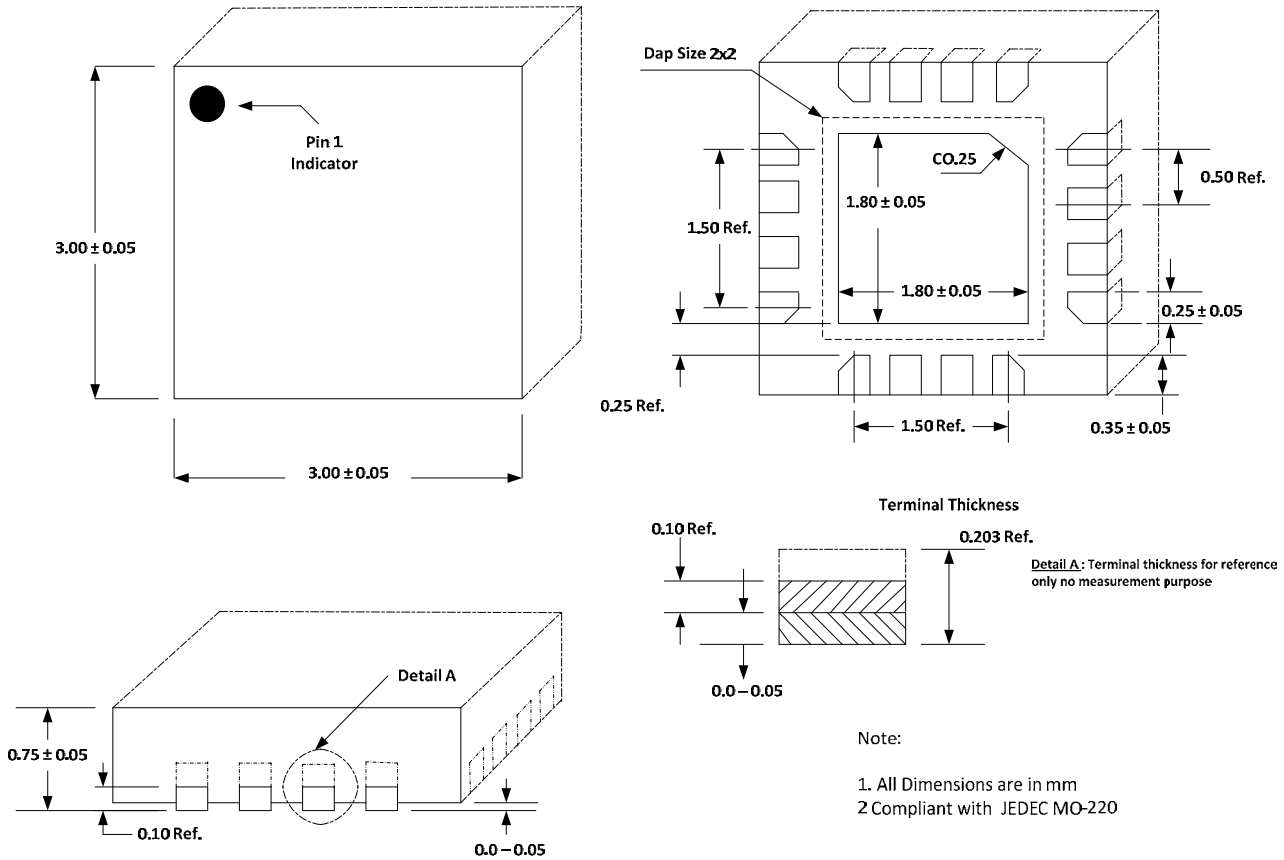

Figure 6. Using Anti-Crush™ Feature at Start-up with Large Output Capacitor and a 10Ω Input Impedance.

PACKAGE OUTLINE DRAWING



Patent Notice

Silicon Labs invests in research and development to help our customers differentiate in the market with innovative low-power, small size, analog-intensive mixed-signal solutions. Silicon Labs' extensive patent portfolio is a testament to our unique approach and world-class engineering team.

The information in this document is believed to be accurate in all respects at the time of publication but is subject to change without notice. Silicon Laboratories assumes no responsibility for errors and omissions, and disclaims responsibility for any consequences resulting from the use of information included herein. Additionally, Silicon Laboratories assumes no responsibility for the functioning of undescribed features or parameters. Silicon Laboratories reserves the right to make changes without further notice. Silicon Laboratories makes no warranty, representation or guarantee regarding the suitability of its products for any particular purpose, nor does Silicon Laboratories assume any liability arising out of the application or use of any product or circuit, and specifically disclaims any and all liability, including without limitation consequential or incidental damages. Silicon Laboratories products are not designed, intended, or authorized for use in applications intended to support or sustain life, or for any other application in which the failure of the Silicon Laboratories product could create a situation where personal injury or death may occur. Should Buyer purchase or use Silicon Laboratories products for any such unintended or unauthorized application, Buyer shall indemnify and hold Silicon Laboratories harmless against all claims and damages.

Silicon Laboratories and Silicon Labs are trademarks of Silicon Laboratories Inc. Other products or brandnames mentioned herein are trademarks or registered trademarks of their respective holders.

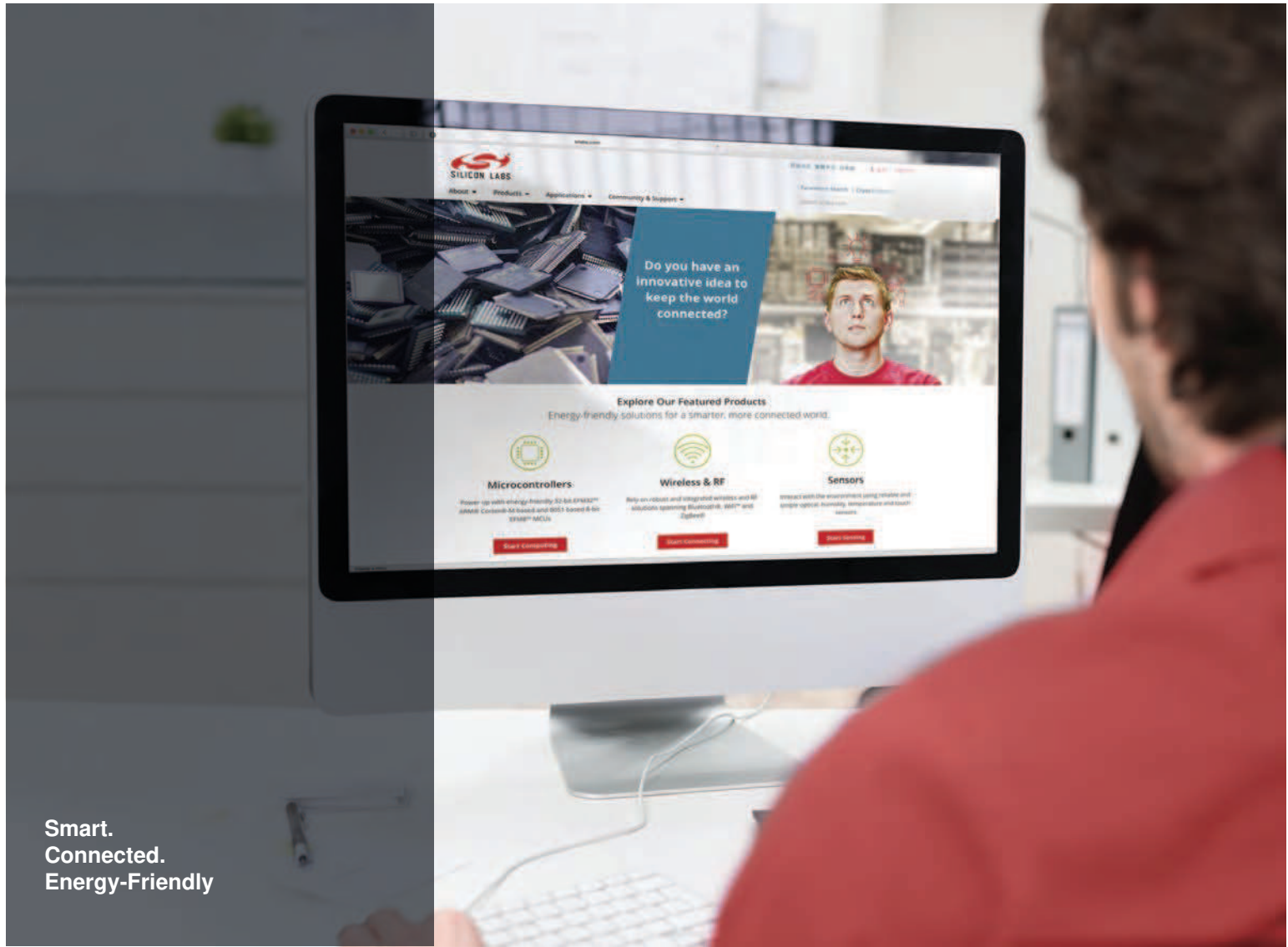

Smart.
Connected.
Energy-Friendly



Products
www.silabs.com/products

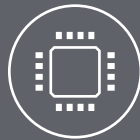

Quality
www.silabs.com/quality



Support and Community
community.silabs.com

Disclaimer

Silicon Laboratories intends to provide customers with the latest, accurate, and in-depth documentation of all peripherals and modules available for system and software implementers using or intending to use the Silicon Laboratories products. Characterization data, available modules and peripherals, memory sizes and memory addresses refer to each specific device, and "Typical" parameters provided can and do vary in different applications. Application examples described herein are for illustrative purposes only. Silicon Laboratories reserves the right to make changes without further notice and limitation to product information, specifications, and descriptions herein, and does not give warranties as to the accuracy or completeness of the included information. Silicon Laboratories shall have no liability for the consequences of use of the information supplied herein. This document does not imply or express copyright licenses granted hereunder to design or fabricate any integrated circuits. The products must not be used within any Life Support System without the specific written consent of Silicon Laboratories. A "Life Support System" is any product or system intended to support or sustain life and/or health, which, if it fails, can be reasonably expected to result in significant personal injury or death. Silicon Laboratories products are generally not intended for military applications. Silicon Laboratories products shall under no circumstances be used in weapons of mass destruction including (but not limited to) nuclear, biological or chemical weapons, or missiles capable of delivering such weapons.

Trademark Information

Silicon Laboratories Inc., Silicon Laboratories, Silicon Labs, SiLabs and the Silicon Labs logo, CMEMS®, EFM, EFM32, EFR, Energy Micro, Energy Micro logo and combinations thereof, "the world's most energy friendly microcontrollers", Ember®, EZLink®, EZMac®, EZRadio®, EZRadioPRO®, DSPLL®, ISOmodem®, Precision32®, ProSLIC®, SiPHY®, USBXpress® and others are trademarks or registered trademarks of Silicon Laboratories Inc. ARM, CORTEX, Cortex-M3 and THUMB are trademarks or registered trademarks of ARM Holdings. Keil is a registered trademark of ARM Limited. All other products or brand names mentioned herein are trademarks of their respective holders.



SILICON LABS

Silicon Laboratories Inc.
400 West Cesar Chavez
Austin, TX 78701
USA

<http://www.silabs.com>