



Chipsmall Limited consists of a professional team with an average of over 10 year of expertise in the distribution of electronic components. Based in Hongkong, we have already established firm and mutual-benefit business relationships with customers from,Europe,America and south Asia,supplying obsolete and hard-to-find components to meet their specific needs.

With the principle of "Quality Parts,Customers Priority,Honest Operation,and Considerate Service",our business mainly focus on the distribution of electronic components. Line cards we deal with include Microchip,ALPS,ROHM,Xilinx,Pulse,ON,Everlight and Freescale. Main products comprise IC,Modules,Potentiometer,IC Socket,Relay,Connector.Our parts cover such applications as commercial,industrial, and automotives areas.

We are looking forward to setting up business relationship with you and hope to provide you with the best service and solution. Let us make a better world for our industry!



## Contact us

Tel: +86-755-8981 8866 Fax: +86-755-8427 6832

Email & Skype: info@chipsmall.com Web: www.chipsmall.com

Address: A1208, Overseas Decoration Building, #122 Zhenhua RD., Futian, Shenzhen, China



# NCV2393, TS393

## Micropower Dual CMOS Voltage Comparator

The NCV2393 and TS393 are micropower CMOS dual voltage comparators. They feature extremely low consumption of 6  $\mu\text{A}$  typical per comparator and operate over a wide temperature range of  $T_A = -40$  to  $125^\circ\text{C}$ . The NCV2393 and TS393 are available in an SOIC-8 package.

### Features

- Extremely Low Supply Current: 6  $\mu\text{A}$  Typical Per Channel
- Wide Supply Range: 2.7 to 16 V
- Extremely Low Input Bias Current: 1 pA Typical
- Extremely Low Input Offset Current: 1 pA Typical
- Input Common Mode Range Includes  $V_{SS}$
- High Input Impedance:  $10^{12} \Omega$
- Pin-to-Pin Compatibility with Dual Bipolar LM393
- NCV Prefix for Automotive and Other Applications Requiring Unique Site and Control Change Requirements; AEC-Q100 Qualified and PPAP Capable
- These Devices are Pb-Free, Halogen Free/BFR Free and are RoHS Compliant



**ON Semiconductor®**

[www.onsemi.com](http://www.onsemi.com)

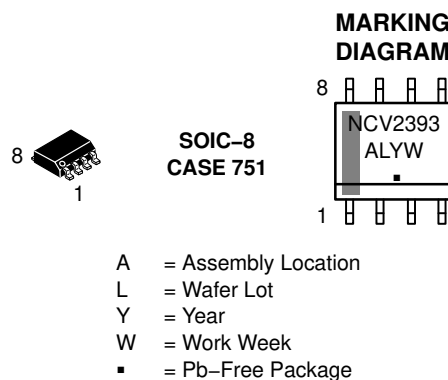

### PIN CONNECTIONS

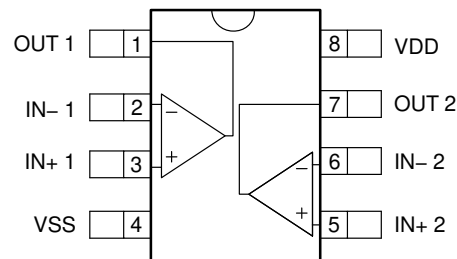

### ORDERING INFORMATION

Device	Package	Shipping†
NCV2393DR2G	SOIC-8 (Pb-Free)	2500 / Tape & Reel
TS393DR2G	SOIC-8 (Pb-Free)	2500 / Tape & Reel

†For information on tape and reel specifications, including part orientation and tape sizes, please refer to our Tape and Reel Packaging Specifications Brochure, BRD8011/D.

# NCV2393, TS393

## PIN DESCRIPTION

Pin	Name	Type	Description
1	OUT 1	Output	Output of comparator 1. The open-drain output requires an external pull-up resistor.
2	IN- 1	Input	Inverting input of comparator 1
3	IN+ 1	Input	Non-inverting input of comparator 1
4	VSS	Power	Negative supply
5	IN+ 2	Input	Non-inverting input of comparator 2
6	IN- 2	Input	Inverting input of comparator 2
7	OUT 2	Output	Output of comparator 2. The open-drain output requires an external pull-up resistor.
8	VDD	Power	Positive supply

## ABSOLUTE MAXIMUM RATINGS (Note 1)

Over operating free-air temperature, unless otherwise stated

Parameter	Limit	Unit
Supply Voltage, $V_S$ ( $V_{DD}-V_{SS}$ )	18	V

## INPUT AND OUTPUT PINS

Input Voltage (Note 2)	18	V
Input Differential Voltage, $V_{ID}$ (Note 3)	$\pm 18$	V
Input Current (through ESD protection diodes)	50	mA
Output Voltage	18	V
Output Current	20	mA

## TEMPERATURE

Storage Temperature	-65 to +150	°C
Junction Temperature	150	°C

## ESD RATINGS

Human Body Model	1500	V
Machine Model	50	V

## LATCH-UP RATINGS

Latch-up Current	100	mA
------------------	-----	----

Stresses exceeding those listed in the Maximum Ratings table may damage the device. If any of these limits are exceeded, device functionality should not be assumed, damage may occur and reliability may be affected.

- Stresses beyond the absolute maximum ratings can lead to reduced reliability and damage.
- Excursions of input voltages may exceed the power supply level. As long as the common mode voltage [ $V_{CM} = (V_{IN+} + V_{IN-})/2$ ] remains within the specified range, the comparator will provide a stable output state. However, the maximum current through the ESD diodes of the input stage must strictly be observed.
- Input differential voltage is the non-inverting input terminal with respect to the inverting input terminal. To prevent damage to the gates, each comparator includes back-to-back zener diodes between input terminals. When differential voltage exceeds 6.2 V, the diodes turn on. Input resistors of 1 k $\Omega$  have been integrated to limit the current in this event.
- This device series incorporates ESD protection and is tested by the following methods:  
ESD Human Body Model tested per AEC-Q100-002 (JEDEC standard: JESD22-A114)  
ESD Machine Model tested per AEC-Q100-003 (JEDEC standard: JESD22-A115)  
Latch-up Current tested per JEDEC standard: JESD78.

## THERMAL INFORMATION (Note 5)

Thermal Metric	Symbol	Value	Unit
Junction-to-Ambient (Note 6)	$\theta_{JA}$	190	°C/W
Junction-to-Case Top	$\Psi_{JT}$	107	°C/W

- Short-circuits can cause excessive heating and destructive dissipation. Values are typical.
- Multilayer board, 1 oz. copper, 400 mm<sup>2</sup> copper area, both junctions heated equally

# NCV2393, TS393

## OPERATING CONDITIONS

Parameter	Symbol	Limit	Unit
Supply Voltage ( $V_{DD} - V_{SS}$ )	$V_S$	+2.7 to +16	V
Operating Free Air Temperature Range	$T_A$	-40 to +125	°C

Functional operation above the stresses listed in the Recommended Operating Ranges is not implied. Extended exposure to stresses beyond the Recommended Operating Ranges limits may affect device reliability.

## ELECTRICAL CHARACTERISTICS: $V_S = +3\text{ V}$

(**Boldface** limits apply over the specified temperature range,  $T_A = -40^\circ\text{C}$  to  $+125^\circ\text{C}$ .)

Parameter	Symbol	Conditions	Min	Typ	Max	Unit
-----------	--------	------------	-----	-----	-----	------

### INPUT CHARACTERISTICS

Offset Voltage	$V_{OS}$	$V_{CM} = \text{mid-supply}$		1.4	13	mV
Input Bias Current (Note 7)	$I_{IB}$	$V_{CM} = \text{mid-supply}$		1		pA
					<b>600</b>	<b>pA</b>
Input Offset Current (Note 7)	$I_{OS}$	$V_{CM} = \text{mid-supply}$		1		pA
					<b>300</b>	<b>pA</b>
Input Common Mode Range	$V_{CM}$		$V_{SS}$		$V_{DD} - 1.5$	V
			$V_{SS}$		$\frac{V_{DD}}{2}$	V
Common Mode Rejection Ratio	CMRR	$V_{CM} = V_{SS}$ to $V_{CM} = V_{DD} - 1.5\text{ V}$		70		dB

### OUTPUT CHARACTERISTICS

Output Voltage Low	$V_{OL}$	$V_{ID} = -1\text{ V}$ , $I_{OL} = +6\text{ mA}$		$V_{SS} + 300$	$V_{SS} + 450$	mV
					<b><math>V_{SS} + 700</math></b>	<b>mV</b>
Output Current High	$I_{OH}$	$V_{ID} = +1\text{ V}$ , $V_{OH} = +3\text{ V}$		2	40	nA
					<b>1000</b>	<b>nA</b>

### DYNAMIC PERFORMANCE

Propagation Delay Low to High	$t_{PLH}$	$V_{CM} = \text{mid-supply}$ , $f = 10\text{ kHz}$ , $R_{PU} = 5.1\text{ k}\Omega$ , $C_L = 50\text{ pF}$	5 mV overdrive		2.1		$\mu\text{s}$
			TTL input		0.6		$\mu\text{s}$
Propagation Delay High to Low	$t_{PHL}$	$V_{CM} = \text{mid-supply}$ , $f = 10\text{ kHz}$ , $R_{PU} = 5.1\text{ k}\Omega$ , $C_L = 50\text{ pF}$	5 mV overdrive		3.9		$\mu\text{s}$
			TTL input		0.2		$\mu\text{s}$

### POWER SUPPLY

Power Supply Rejection Ratio	PSRR	$V_S = +3\text{ V}$ to $+5\text{ V}$		70		dB
Quiescent Current	$I_{DD}$	Per channel, no load, output = LOW		6	15	$\mu\text{A}$
					<b>20</b>	<b><math>\mu\text{A}</math></b>

Product parametric performance is indicated in the Electrical Characteristics for the listed test conditions, unless otherwise noted. Product performance may not be indicated by the Electrical Characteristics if operated under different conditions.

7. Guaranteed by characterization and/or design.

# NCV2393, TS393

**ELECTRICAL CHARACTERISTICS:**  $V_S = +5\text{ V}$ , unless otherwise noted  
**(Boldface limits apply over the specified temperature range,  $T_A = -40^\circ\text{C}$  to  $+125^\circ\text{C}$ .)**

Parameter	Symbol	Conditions	Min	Typ	Max	Unit
-----------	--------	------------	-----	-----	-----	------

## INPUT CHARACTERISTICS

Offset Voltage	$V_{OS}$	$V_{CM} = \text{mid-supply V}$ , $V_S = 5\text{ V to }10\text{ V}$		1.4	13	mV
Input Bias Current (Note 8)	$I_{IB}$	$V_{CM} = \text{mid-supply}$		1		pA
					<b>600</b>	<b>pA</b>
Input Offset Current (Note 8)	$I_{OS}$	$V_{CM} = \text{mid-supply}$		1		pA
					<b>300</b>	<b>pA</b>
Input Common Mode Range	$V_{CM}$		$V_{SS}$		$V_{DD} - 1.5$	V
			$V_{SS}$		$V_{DD} - 2$	V
Common Mode Rejection Ratio	CMRR	$V_{CM} = V_{SS}$ to $V_{CM} = V_{DD} - 1.5\text{ V}$		71		dB

## OUTPUT CHARACTERISTICS

Output Voltage Low	$V_{OL}$	$V_{ID} = -1\text{ V}$ , $I_{OL} = +6\text{ mA}$		$V_{SS} + 260$	$V_{SS} + 350$	mV
					<b><math>V_{SS} + 550</math></b>	<b>mV</b>
Output Current High	$I_{OH}$	$V_{ID} = +1\text{ V}$ , $V_{OH} = +5\text{ V}$		2	40	nA
					<b>1000</b>	<b>nA</b>

## DYNAMIC PERFORMANCE

Fall Time	$t_{FALL}$	50 mV overdrive, $f = 10\text{ kHz}$ , $R_{PU} = 5.1\text{ k}\Omega$ , $C_L = 50\text{ pF}$		25		ns
Propagation Delay Low to High	$t_{PLH}$	$V_{CM} = \text{mid-supply}$ , $f = 10\text{ kHz}$ , $R_{PU} = 5.1\text{ k}\Omega$ , $C_L = 50\text{ pF}$	5 mV overdrive		2.1	$\mu\text{s}$
			10 mV overdrive		1.2	$\mu\text{s}$
			20 mV overdrive		0.8	$\mu\text{s}$
			40 mV overdrive		0.5	$\mu\text{s}$
			TTL input		0.6	$\mu\text{s}$
Propagation Delay High to Low	$t_{PHL}$	$V_{CM} = \text{mid-supply}$ , $f = 10\text{ kHz}$ , $R_{PU} = 5.1\text{ k}\Omega$ , $C_L = 50\text{ pF}$	5 mV overdrive		5.8	$\mu\text{s}$
			10 mV overdrive		3.2	$\mu\text{s}$
			20 mV overdrive		1.7	$\mu\text{s}$
			40 mV overdrive		1.0	$\mu\text{s}$
			TTL input		0.3	$\mu\text{s}$

## POWER SUPPLY

Power Supply Rejection Ratio	PSRR	$V_S = +5\text{ V to }+10\text{ V}$		80		dB
Quiescent Current	$I_{DD}$	Per channel, no load, output = LOW		6	15	$\mu\text{A}$
					<b>20</b>	<b><math>\mu\text{A}</math></b>

Product parametric performance is indicated in the Electrical Characteristics for the listed test conditions, unless otherwise noted. Product performance may not be indicated by the Electrical Characteristics if operated under different conditions.

8. Guaranteed by characterization and/or design

# NCV2393, TS393

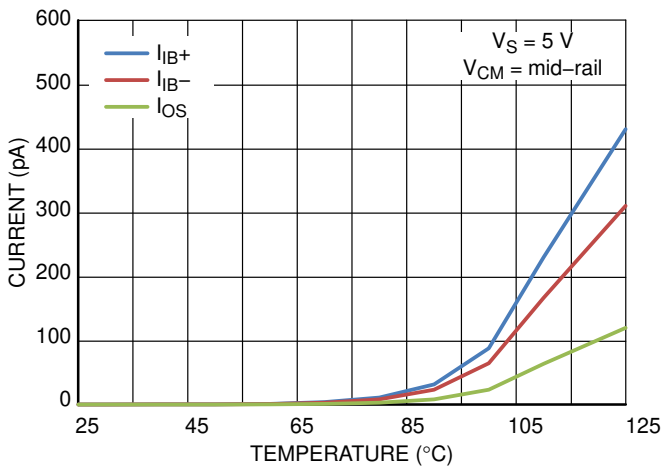

Figure 1.  $I_B$  and  $I_{OS}$  vs. Temperature

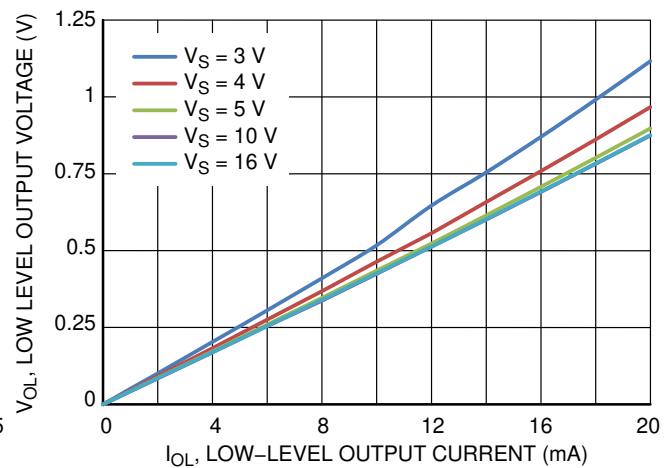

Figure 2.  $V_{OL}$  vs.  $I_{OL}$

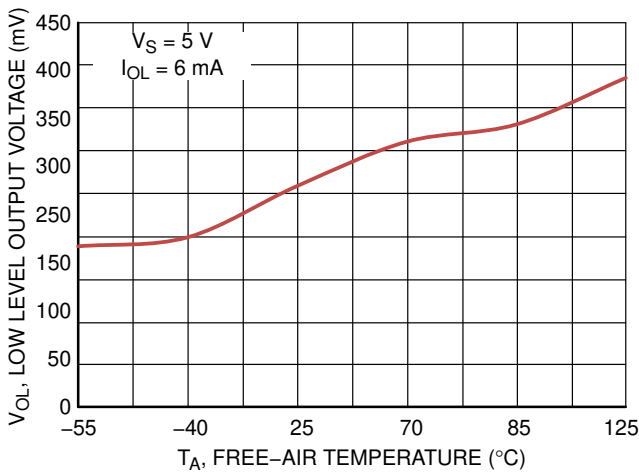

Figure 3.  $V_{OL}$  vs. Temperature

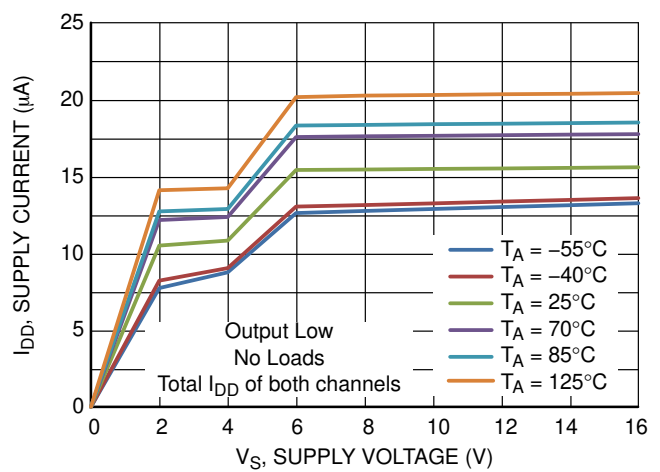

Figure 4.  $I_{DD}$  vs.  $V_S$

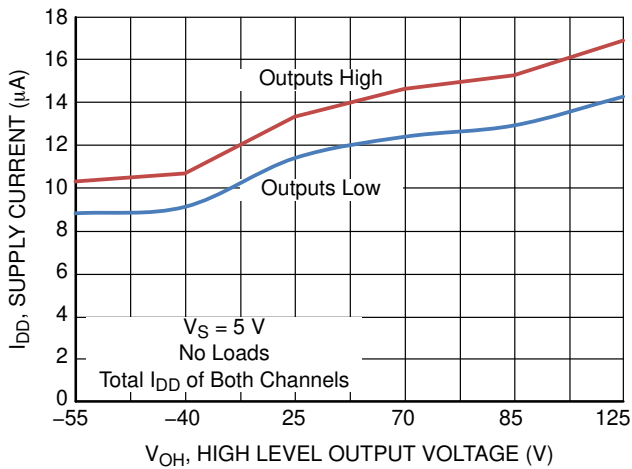

Figure 5.  $I_{DD}$  vs. Temperature

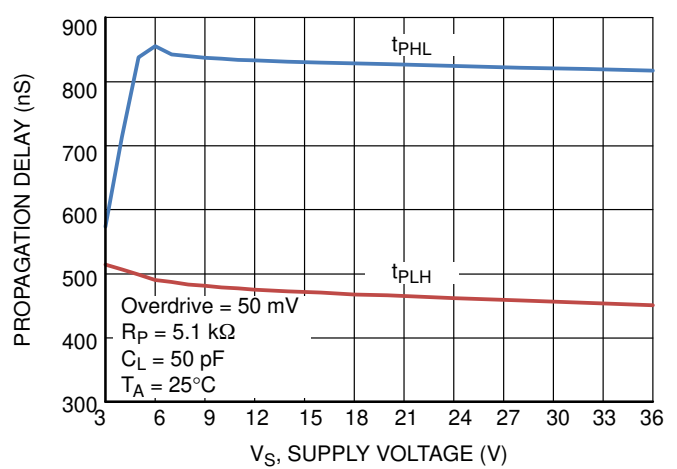

Figure 6. Propagation Delay vs.  $V_S$

# NCV2393, TS393

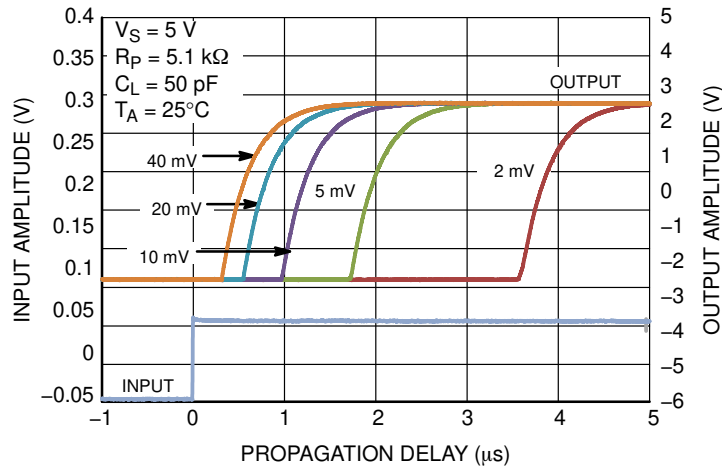

Figure 7.  $t_{pLH}$  vs. Overdrive

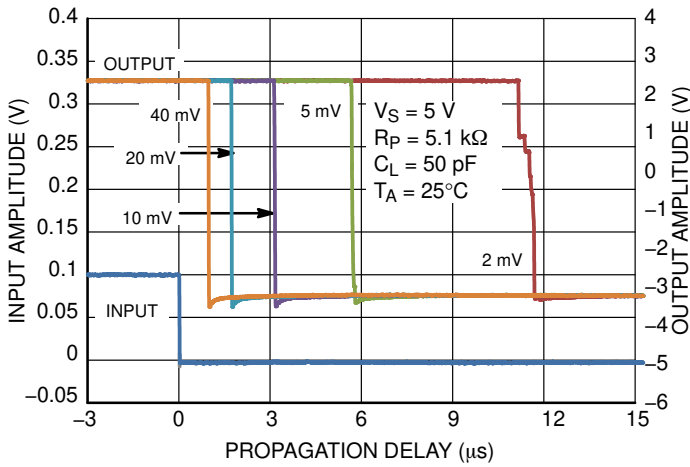

Figure 8.  $t_{pHL}$  vs. Overdrive

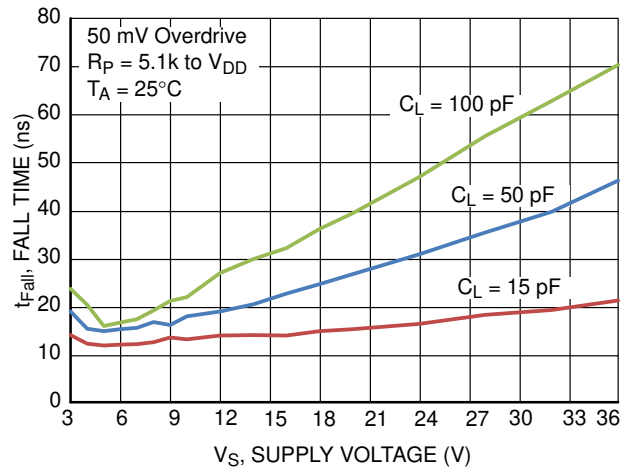

Figure 9. Fall Time vs.  $V_S$

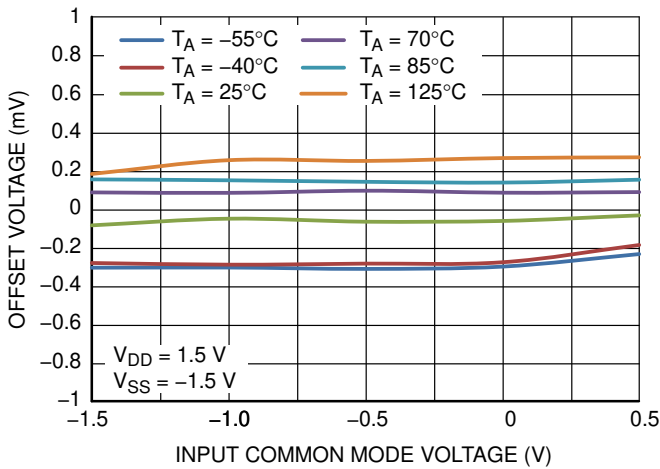

Figure 10.  $V_{OS}$  vs.  $V_{CM}$  ( $V_S = 3\text{ V}$ )

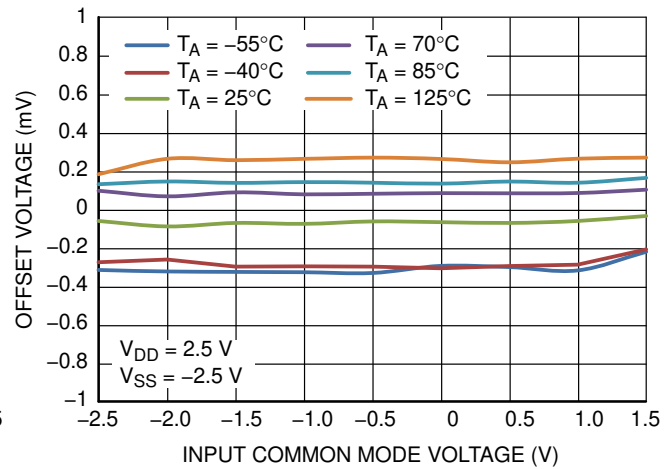
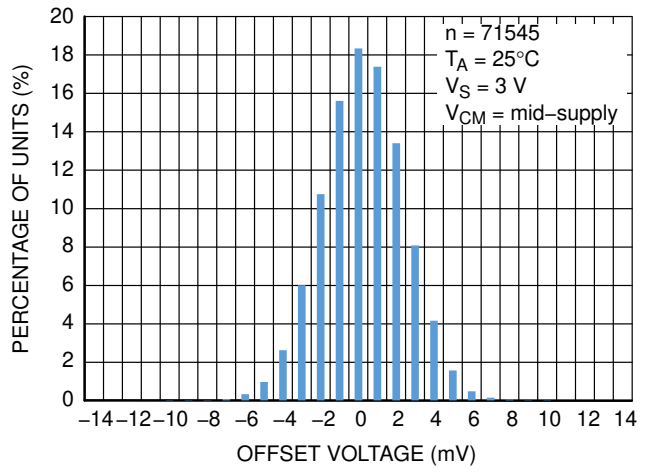
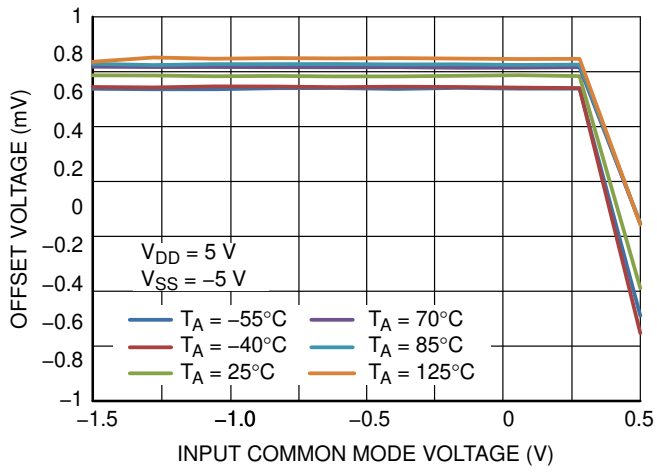

Figure 11.  $V_{OS}$  vs.  $V_{CM}$  ( $V_S = 5\text{ V}$ )

# NCV2393, TS393





# NCV2393, TS393

## PACKAGE DIMENSIONS

SOIC-8 NB  
CASE 751-07  
ISSUE AK

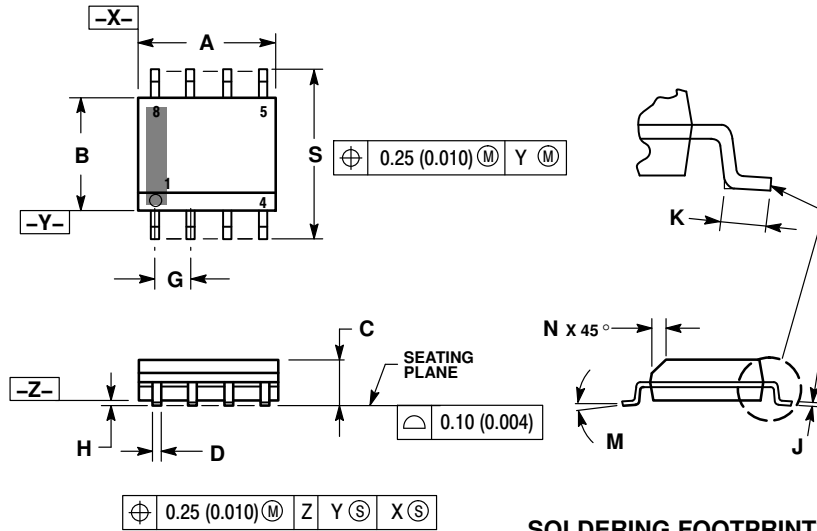

**NOTES:**

1. DIMENSIONING AND TOLERANCING PER ANSI Y14.5M, 1982.
2. CONTROLLING DIMENSION: MILLIMETER.
3. DIMENSION A AND B DO NOT INCLUDE MOLD PROTRUSION.
4. MAXIMUM MOLD PROTRUSION 0.15 (0.006) PER SIDE.
5. DIMENSION D DOES NOT INCLUDE DAMBAR PROTRUSION. ALLOWABLE DAMBAR PROTRUSION SHALL BE 0.127 (0.005) TOTAL IN EXCESS OF THE D DIMENSION AT MAXIMUM MATERIAL CONDITION.
6. 751-01 THRU 751-06 ARE OBSOLETE. NEW STANDARD IS 751-07.

DIM	MILLIMETERS		INCHES	
	MIN	MAX	MIN	MAX
A	4.80	5.00	0.189	0.197
B	3.80	4.00	0.150	0.157
C	1.35	1.75	0.053	0.069
D	0.33	0.51	0.013	0.020
G	1.27 BSC		0.050 BSC	
H	0.10	0.25	0.004	0.010
J	0.19	0.25	0.007	0.010
K	0.40	1.27	0.016	0.050
M	0°	8°	0°	8°
N	0.25	0.50	0.010	0.020
S	5.80	6.20	0.228	0.244

**SOLDERING FOOTPRINT\***

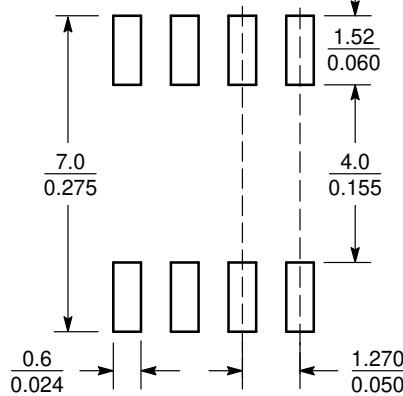

SCALE 6:1 (mm/inches)

\*For additional information on our Pb-Free strategy and soldering details, please download the ON Semiconductor Soldering and Mounting Techniques Reference Manual, SOLDERRM/D.

ON Semiconductor and are trademarks of Semiconductor Components Industries, LLC dba ON Semiconductor or its subsidiaries in the United States and/or other countries. ON Semiconductor owns the rights to a number of patents, trademarks, copyrights, trade secrets, and other intellectual property. A listing of ON Semiconductor's product/patent coverage may be accessed at [www.onsemi.com/site/pdf/Patent-Marking.pdf](http://www.onsemi.com/site/pdf/Patent-Marking.pdf). ON Semiconductor reserves the right to make changes without further notice to any products herein. ON Semiconductor makes no warranty, representation or guarantee regarding the suitability of its products for any particular purpose, nor does ON Semiconductor assume any liability arising out of the application or use of any product or circuit, and specifically disclaims any and all liability, including without limitation special, consequential or incidental damages. Buyer is responsible for its products and applications using ON Semiconductor products, including compliance with all laws, regulations and safety requirements or standards, regardless of any support or applications information provided by ON Semiconductor. "Typical" parameters which may be provided in ON Semiconductor data sheets and/or specifications can and do vary in different applications and actual performance may vary over time. All operating parameters, including "Typicals" must be validated for each customer application by customer's technical experts. ON Semiconductor does not convey any license under its patent rights nor the rights of others. ON Semiconductor products are not designed, intended, or authorized for use as a critical component in life support systems or any FDA Class 3 medical devices or medical devices with a same or similar classification in a foreign jurisdiction or any devices intended for implantation in the human body. Should Buyer purchase or use ON Semiconductor products for any such unintended or unauthorized application, Buyer shall indemnify and hold ON Semiconductor and its officers, employees, subsidiaries, affiliates, and distributors harmless against all claims, costs, damages, and expenses, and reasonable attorney fees arising out of, directly or indirectly, any claim of personal injury or death associated with such unintended or unauthorized use, even if such claim alleges that ON Semiconductor was negligent regarding the design or manufacture of the part. ON Semiconductor is an Equal Opportunity/Affirmative Action Employer. This literature is subject to all applicable copyright laws and is not for resale in any manner.

**PUBLICATION ORDERING INFORMATION**

**LITERATURE FULFILLMENT:**  
Literature Distribution Center for ON Semiconductor  
19521 E. 32nd Pkwy, Aurora, Colorado 80011 USA  
**Phone:** 303-675-2175 or 800-344-3860 Toll Free USA/Canada  
**Fax:** 303-675-2176 or 800-344-3867 Toll Free USA/Canada  
**Email:** [orderlit@onsemi.com](mailto:orderlit@onsemi.com)

**N. American Technical Support:** 800-282-9855 Toll Free USA/Canada  
**Europe, Middle East and Africa Technical Support:** Phone: 421 33 790 2910  
**Japan Customer Focus Center** Phone: 81-3-5817-1050

**ON Semiconductor Website:** [www.onsemi.com](http://www.onsemi.com)  
**Order Literature:** <http://www.onsemi.com/orderlit>

For additional information, please contact your local Sales Representative