



Chipsmall Limited consists of a professional team with an average of over 10 year of expertise in the distribution of electronic components. Based in Hongkong, we have already established firm and mutual-benefit business relationships with customers from,Europe,America and south Asia,supplying obsolete and hard-to-find components to meet their specific needs.

With the principle of “Quality Parts,Customers Priority,Honest Operation,and Considerate Service”,our business mainly focus on the distribution of electronic components. Line cards we deal with include Microchip,ALPS,ROHM,Xilinx,Pulse,ON,Everlight and Freescale. Main products comprise IC,Modules,Potentiometer,IC Socket,Relay,Connector.Our parts cover such applications as commercial,industrial, and automotives areas.

We are looking forward to setting up business relationship with you and hope to provide you with the best service and solution. Let us make a better world for our industry!



## Contact us

Tel: +86-755-8981 8866 Fax: +86-755-8427 6832

Email & Skype: info@chipsmall.com Web: www.chipsmall.com

Address: A1208, Overseas Decoration Building, #122 Zhenhua RD., Futian, Shenzhen, China



## Single supply stereo digital audio line driver with 2.2 Vrms capless outputs

### Features

- Single 3.0 to 5.5 V supply for DAC and line driver
- Audio line output: 2.2 Vrms for all  $V_{CC}$  range
- 16- to 24-bit audio data format stereo DAC, 32 to 48 kHz sample rate
- I<sup>2</sup>S, right- or left-justified compatible digital audio interface
- 95 dB SNR A-weighted at 48 kHz,  $V_{CC} = 5$  V
- 7.4 mA current consumption at  $V_{CC} = 3.0$  V, full operation
- Internal negative power supply to ensure ground-referenced, capless outputs
- No external capacitor needed for the negative power supply generation
- Integrated structure to suppress pop and click noise
- Available in thin QFN20 4 mm x 4 mm package

### Applications

- Digital set-top boxes
- DVD players
- Digital TVs
- Notebooks
- Portable audio equipment
- Sound cards

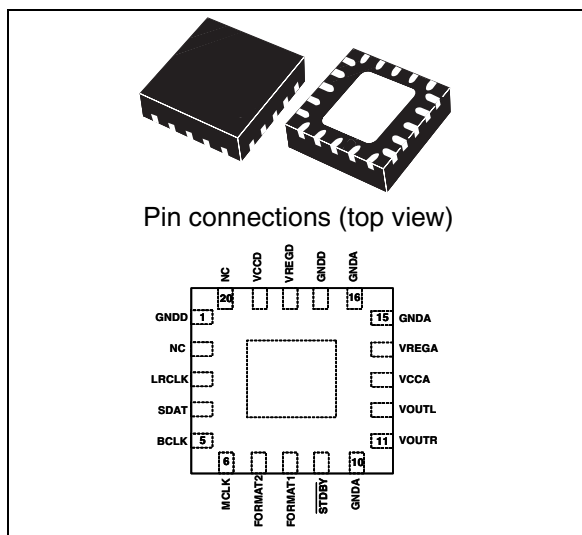

### Description

The TS4657 is a stereo DAC that integrates a high-performance audio line driver capable of generating a 2.2 Vrms output level from a single 3.0 to 5.5 V supply.

One single supply is sufficient for the digital and analog parts of the circuit, thus eliminating the need for external regulators.

The TS4657 is a low-power consumption device. It features only 22 mW power dissipation at a 3.0 V power supply in full operation.

A 16-bit multi-bit sigma delta DAC is used, operating at 256xFs with oversampling digital interpolation filters. The digital audio data can be 16- to 24-bit long and sample rates from 32 to 48 kHz are supported.

The output stage signal is ground-referenced by using an internal self-generated negative power supply, and as such external bulky output coupling capacitors are not necessary.

The TS4657 is packaged in a small 4 x 4 mm QFN20 package, ideal for portable applications.

# Contents

- 1      Block diagram and pin description ..... 3**
- 2      Absolute maximum ratings ..... 5**
- 3      Electrical characteristics ..... 6**
  - 3.1    Power characteristics ..... 6
  - 3.2    Package thermal characteristics ..... 6
  - 3.3    DAC and output stage performances ..... 7
    - 3.3.1    Terminology ..... 8
  - 3.4    Digital filter characteristics ..... 9
    - 3.4.1    DAC digital filter response ..... 10
  - 3.5    Electrical measurement curves ..... 11
- 4      Application information ..... 19**
  - 4.1    Serial audio interface ..... 19
    - 4.1.1    Master clock and data clocks ..... 19
    - 4.1.2    Digital audio input format ..... 19
  - 4.2    Power-management unit ..... 20
  - 4.3    Recommended power-up and power-down sequences ..... 21
    - 4.3.1    Power-up ..... 21
    - 4.3.2    Power-down ..... 21
- 5      Package information ..... 22**
  - 5.1    QFN20 package information ..... 23
- 6      Ordering information ..... 24**
- 7      Revision history ..... 25**

# 1 Block diagram and pin description

Figure 1. Block diagram

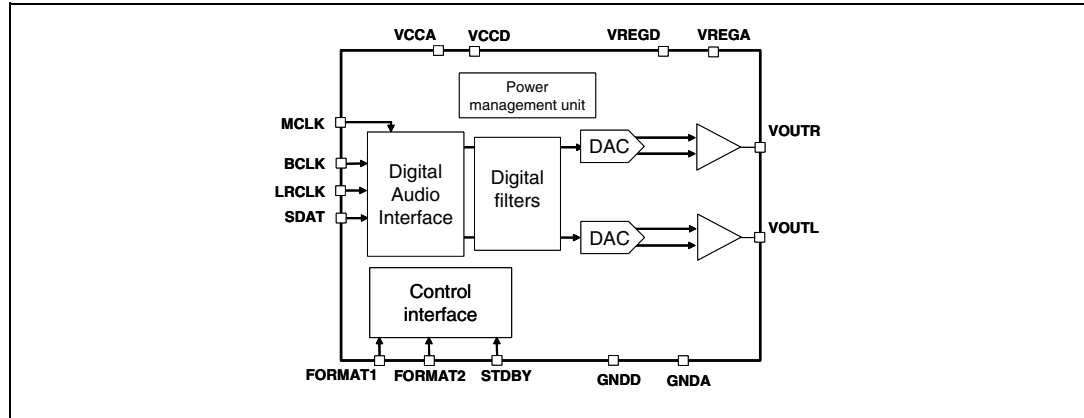

Table 1. Pin description

Pin name	Pin	I/O	Function
GNDD	1	Supply	Digital ground, connected to GND
NC	2	Non-connected pin	This pin must remain non-connected.
LRCLK	3	Digital input	Channel select clock input
SDAT	4	Digital input	Serial audio data input
BCLK	5	Digital input	Bit clock input
MCLK	6	Digital input	Master clock input
FORMAT2	7	Digital input	Selection of the digital data audio format.
FORMAT1	8	Digital input	Selection of the digital data audio format.
$\overline{\text{STDBY}}$	9	Digital input	Input for Standby pin. $\overline{\text{STDBY}}=\text{VIL}$ : the TS4657 is in shutdown mode.
GNDA	10	Supply	Analog ground, connect to GND.
VOUTR	11	Analog output	Right channel analog output
VOUTL	12	Analog output	Left channel analog output
VCCA	13	Supply	Main analog power supply, connected to VCCD
VREGA	14	Supply	Decoupling pin for the analog part
GNDA	15	Supply	Analog ground, connected to GND
GNDA	16	Supply	Analog ground, connect to GND
GNDD	17	Supply	Digital ground, connected to GND
VREGD	18	Supply	Decoupling pin for the digital part
VCCD	19	Supply	Main digital power supply. Connect to VCCA
NC	20	Non-connected pin	This pin must remain non-connected.

Figure 2. Typical application schematics

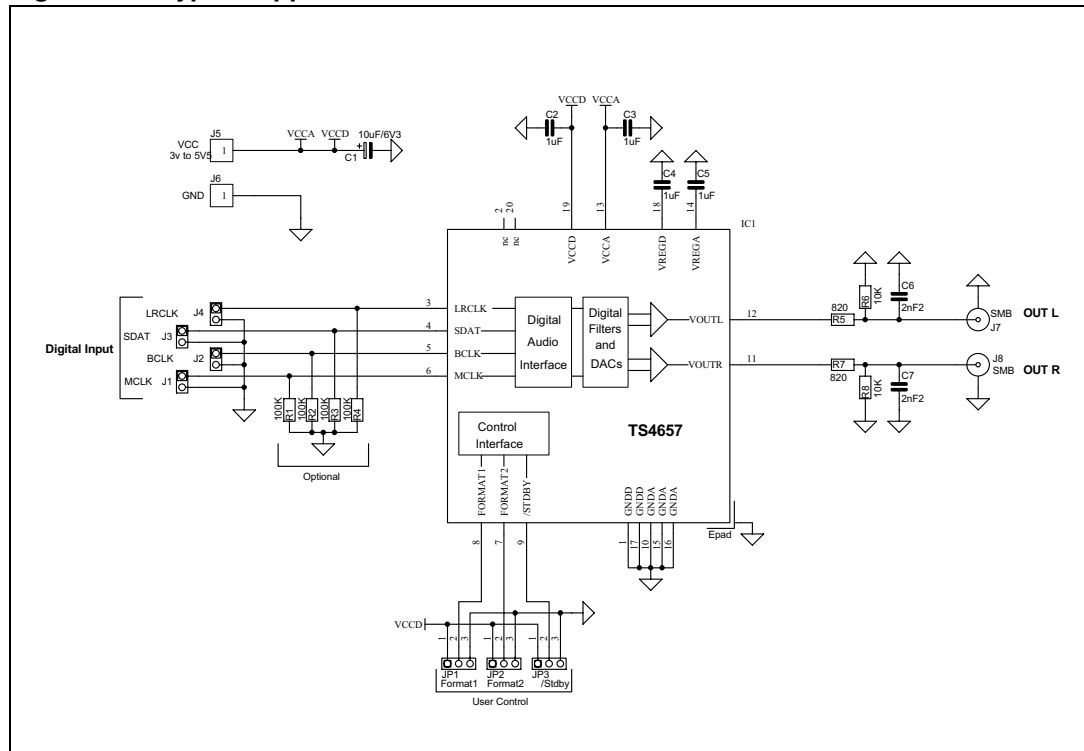
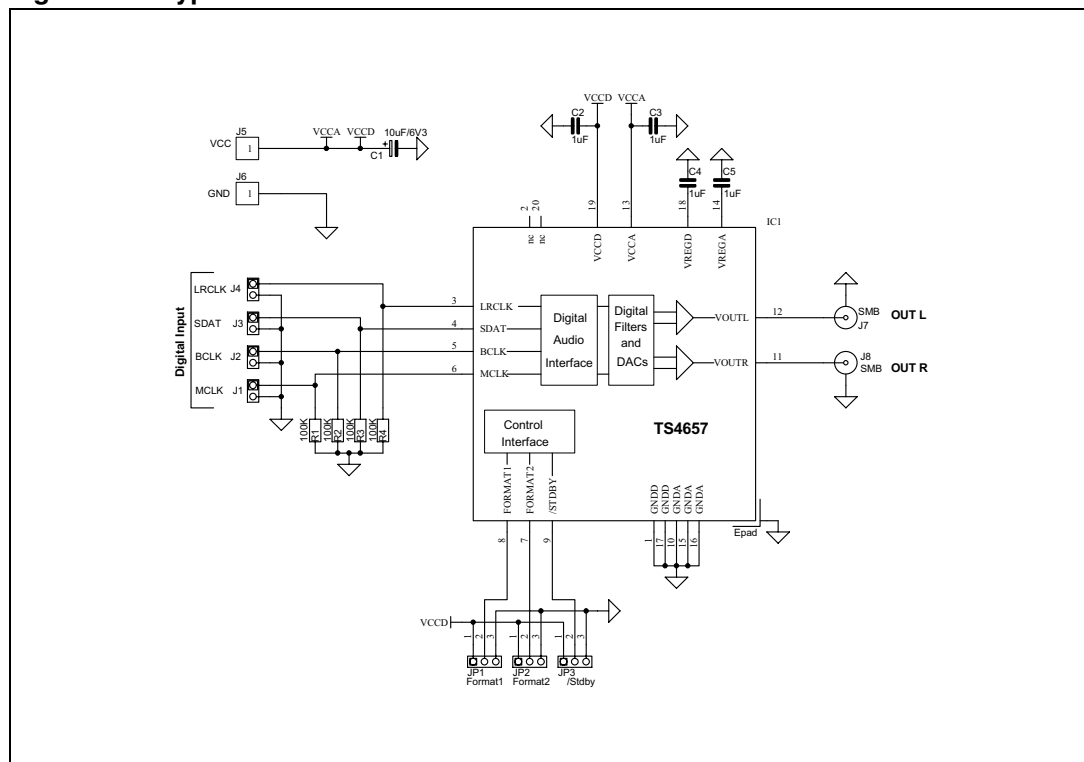

Figure 3. Typical test schematics



## 2 Absolute maximum ratings

**Table 2. Key parameters and their absolute maximum ratings**

Symbol	Parameter	Value	Unit
$V_{CC}$	Supply voltage <sup>(1)</sup>	5.5	V
$V_i$	Digital input voltage MCLK, BCLK, LRCLK, SDAT, FORMAT1, FORMAT2, STDBY	GND to $V_{CC}$	V
$T_{oper}$	Operating free air temperature range	-40 to + 85	°C
$T_{stg}$	Storage temperature	-65 to +150	°C
$T_j$	Maximum junction temperature	150	°C
$R_{thja}$	Thermal resistance junction to ambient	100	°C/W
ESD	Human body model	2	kV
ESD	Machine model	200	V
	Latch-up immunity	Class A	
	Lead temperature (soldering, 10 secs)	260	°C

1. All voltage values are measured with respect to ground.

### 3 Electrical characteristics

#### 3.1 Power characteristics

Table 3.  $V_{CC} = 3.3\text{ V}$   $T = 25^\circ\text{ C}$  (unless otherwise specified)

Symbol	Parameter	Min.	Typ.	Max.	Unit
$V_{CC}$	Power supply	3.0		5.5	V
$I_{CC}$	Total supply current. Full operation, $R_L = 10\text{ K}\Omega$ $v_{stdby} \geq 2.0\text{ V}$ $V_{CC} = 3.0\text{ V}$ $V_{CC} = 5.0\text{ V}$		7.4 8	9.5 9.8	mA
$I_{CCstby}$	Standby current consumption. $V_{CC} = 3\text{ V}$ to $V_{CC} = 5.5\text{ V}$ $V_{stdby} = 0\text{ V}$ $V_{stdby} = 0.8\text{ V}$		25 50	1000 2000	nA

#### 3.2 Package thermal characteristics

Table 4. Operating conditions

Symbol	Parameter	Min.	Typ.	Max.	Unit
$R_{thja}$	Thermal resistance junction to ambient for QFN20 <sup>(1)</sup>		40		$^\circ\text{C/W}$

1. With heat sink surface = 125 mm<sup>2</sup>.

### 3.3 DAC and output stage performances

**Table 5.**  $V_{CC} = 3.0\text{ V}$  to  $V_{CC} = 5.5\text{ V}$ ,  $R_{Load} = 10\text{ k}\Omega$   $C_{Load} = 100\text{ pF}$ ,  $T = 25^\circ\text{ C}$   
(unless otherwise specified)

Symbol	Parameter	Min.	Typ.	Max.	Unit
<b>Operating conditions</b>					
-	Audio data input format	16		24	bits
$F_s$	Sampling frequency	32		48	kHz
$R_L$	Load resistor	5	10		$k\Omega$
$C_L$	Load capacitance		100	150	pF
<b>Digital input characteristics</b>					
$V_{IL}$	Low-level input voltage			0.8	V
$V_{IH}$	High-level input voltage	2			V
<b>Dynamic parameters</b>					
$V_{outRMS}$	Full-scale output voltage swing $V_{in}$ at 0 dBFS; $R_L \geq R_{Lmin}$ ; $C_L=100\text{ pF}$	2.1	2.2		Vrms

**Table 6.**  $V_{CC} = 3.3\text{ V}$ ,  $R_{Load} = 10\text{ k}\Omega$   $C_{Load} = 100\text{ pF}$ ,  $T = 25^\circ\text{ C}$  (unless otherwise specified)

Symbol	Parameter	Min.	Typ.	Max.	Unit
<b>Dynamic parameters</b>					
DR	Dynamic range. A-weighted 16-bit data; $V_{in}$ at -60 dBFS, $F_S = 48\text{ kHz}$ , $F_{in} = 1\text{ kHz}$	88	93		dB
SNR	Signal-to-noise ratio, $F_S = 48\text{ kHz}$ , $F_{in} = 1\text{ kHz}$ , referred to output $V_{in}$ at -6 dBFS; A-weighted, 18-bit data input $V_{in}$ at -6 dBFS; unweighted, 18-bit data input $V_{in}$ at 0 dBFS; A-weighted, 16-bit data input	89 87 87	94.5 92.5 93		dB
THD+N	Total harmonic distortion and noise. $F_{in} = 1\text{ kHz}$ $V_{in}$ at -20 dBFS, 18-bit data input $V_{in}$ at -6 dBFS, 18-bit data input $V_{in}$ at 0 dBFS, 16-bit data input	74	72 82 81		dB
PSRR	Power supply rejection ratio, $V_{ripple} = 200\text{ mVpp}$ $F = 217\text{ Hz}$ $F = 1\text{ kHz}$ $20\text{ Hz} < F < 20\text{ kHz}$		80 71 46		dB
LRiso	Channel separation. 1 kHz, $V_{in}$ at 0 dBFS		100		dB
$V_{oo}$	Output offset voltage	-20		20	mV
	Gain channel balance	-0.2	0.01	0.2	dB
$t_{wu}$	Wake-up time		4.5		ms



**Table 7.**  $V_{CC} = 5\text{ V}$ ,  $R_{load} = 10\text{ k}\Omega$ ,  $C_{load} = 100\text{ pF}$ ,  $T = 25^\circ\text{ C}$  (unless otherwise specified)

Symbol	Parameter	Min.	Typ.	Max.	Unit
DR	Dynamic range; A-weighted 16-bit data; measured at -60 dBFS, $F_S = 48\text{ kHz}$ , $F_{in} = 1\text{ kHz}$	88	93		dB
SNR	Signal-to-noise ratio, $F_S = 48\text{ kHz}$ , $F_{in} = 1\text{ kHz}$ , referred to output $V_{in}$ at -6 dBFS; A-weighted, 18-bit data input $V_{in}$ at -6 dBFS; unweighted, 18-bit data input $V_{in}$ at 0 dBFS; A-weighted, 16-bit data input	89	95 93 93		dB
THD+N	Total harmonic distortion and noise. $F_{in} = 1\text{ kHz}$ $V_{in}$ at -20 dBFS $V_{in}$ at -6 dBFS $V_{in}$ at 0 dBFS	74	72 82.5 81.5		dB
PSRR	Power supply rejection ratio, $V_{ripple} = 200\text{ mVpp}$ $F = 217\text{ Hz}$ $F = 1\text{ kHz}$ $20\text{ Hz} < F < 20\text{ kHz}$		80 73 48		dB
LRiso	Channel separation. 1 kHz, $V_{in}$ at 0 dBFS		100		dB
$V_{oo}$	Output offset voltage	-20		20	mV
	Gain channel balance	-0.2	0.01	0.2	dB
$t_{wu}$	Wake-up time <sup>(1)</sup>	3	4.5	6	ms

1. See timing diagram in application information.

### 3.3.1 Terminology

SNR: signal-to-noise ratio is expressed in dB. The theoretical formula is:

$$SNR_{dB} = 10\log\left(\frac{V_{H_1}^2}{V_{noise}^2}\right)$$

where  $V_{noise}$  is the integrated noise from 20 Hz to 20 kHz and  $V_{H_1}$  is the fundamental of the signal.

For unweighted measurements, the SNR is given by:

$$SNR_{dB} = 10\log\left[\frac{V_{H_1}^2}{\int_{20\text{Hz}}^{20\text{kHz}} |u(f)(v_{noise}(f))|^2 df}\right]$$

where  $v_{noise}$  is the noise spectral density and  $u(f)$  is the unweighted filter transfer function (20 Hz, 20 kHz).

For A-weighted measurements:

$$SNR_{dB_A} = 10\log\left[\frac{V_{H_1}^2}{\int_{20\text{Hz}}^{20\text{kHz}} |A(f)(v_{noise}(f))|^2 df}\right]$$

where  $v_{noise}$  is the noise spectral density and  $A(f)$  is the A-weighted filter transfer function.

THD+N: total harmonic distortion and noise-to signal-ratio is expressed in dB. It is given by:

$$\text{THD} + N_{\text{dB}} = 10 \log \left[ \frac{\sum_{i=2}^k V_{H_i}^2 + V_{\text{noise}}^2}{V_{\text{outrms}}^2} \right]$$

where  $V_{H_i}$  is the rms value of the harmonic components.

SINAD: signal and noise distortion is expressed in dB. The equation is given by:

$$\text{SINAD}_{\text{dB}} = 10 \log \left[ \frac{V_{\text{outrms}}^2}{\sum_{i=2}^k V_{H_i}^2 + V_{\text{noise}}^2} \right]$$

DR: dynamic range is expressed in dB, with the following equation:

$$\text{DR}_{\text{dB}} = 10 \log \left[ \frac{\sum_{i=1}^k V_{H_i}^2}{V_{\text{noise}}^2} \right]$$

### 3.4 Digital filter characteristics

**Table 8.**  $V_{\text{CC}} = 3.3 \text{ V}$   $T = 25^\circ \text{ C}$  (unless otherwise specified)

Symbol	Parameter	Min.	Typ.	Max.	Unit
-	Passband edge (-3 dB)		0.48Fs		
-	Passband ripple $f < 0.45 \text{ Fs}$			+/- 0.1	dB
-	Stopband attenuation $f > 0.55 \text{ Fs}$	-50			dB

### 3.4.1 DAC digital filter response

Figure 4. DAC digital filter frequency response from 32 to 48 kHz

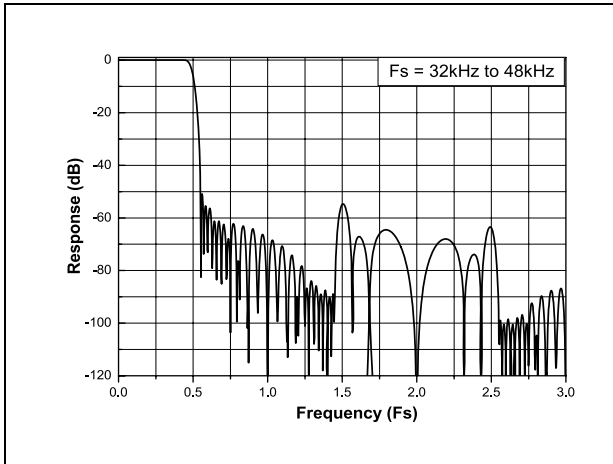

Figure 5. DAC digital filter transition band from 32 to 48 kHz

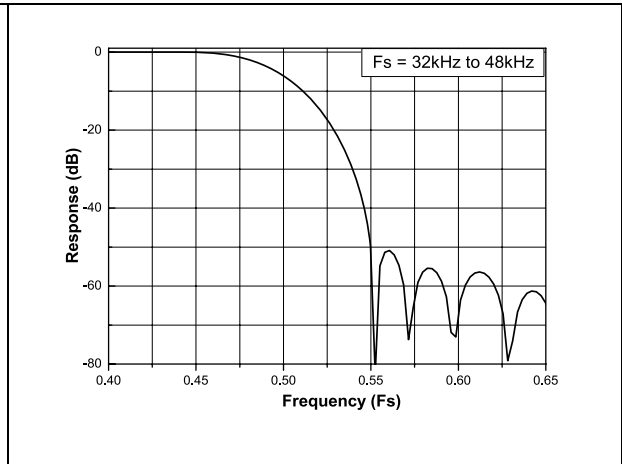
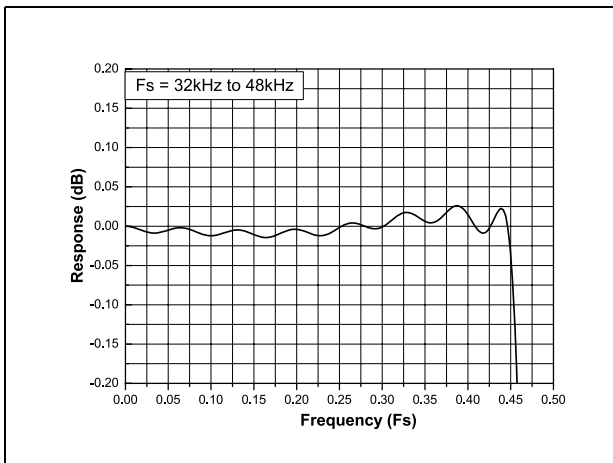

Figure 6. DAC digital filter ripple from 32 to 48 kHz



### 3.5 Electrical measurement curves

Figure 7. Crosstalk vs. frequency

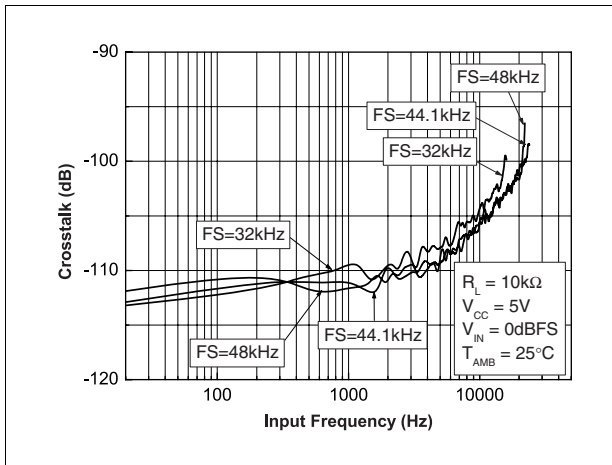

Figure 8. Crosstalk vs. frequency

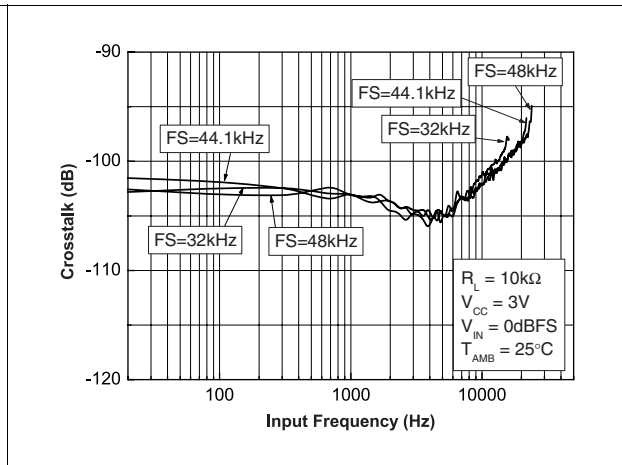

Figure 9. Frequency response

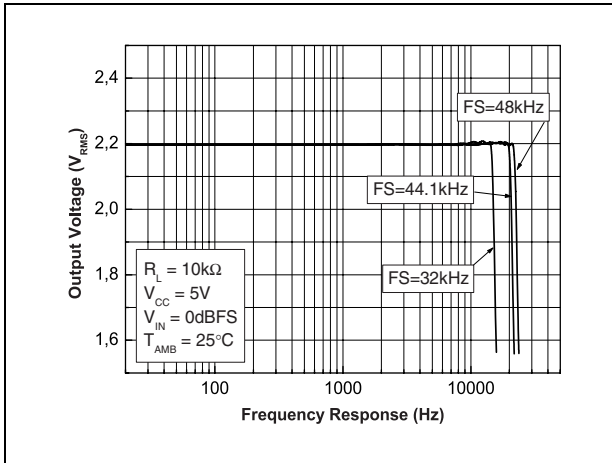

Figure 10. Frequency response

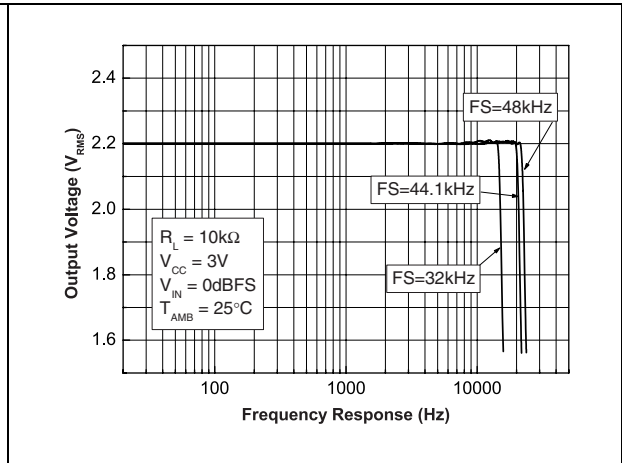

Figure 11. Current consumption vs. power supply voltage

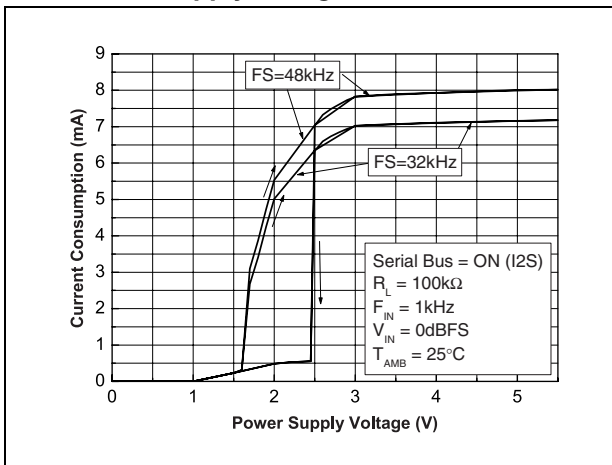

Figure 12. Current consumption vs. standby voltage

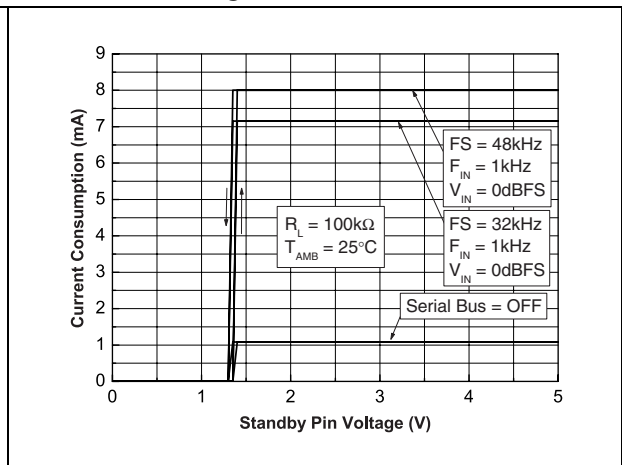

Figure 13. Output swing vs. power supply voltage

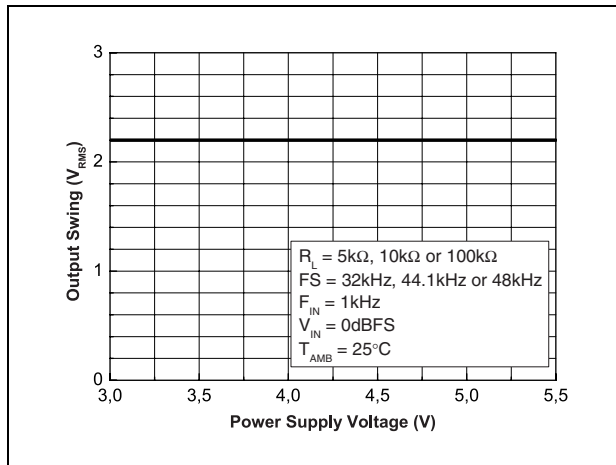

Figure 14. Power dissipation vs. frequency

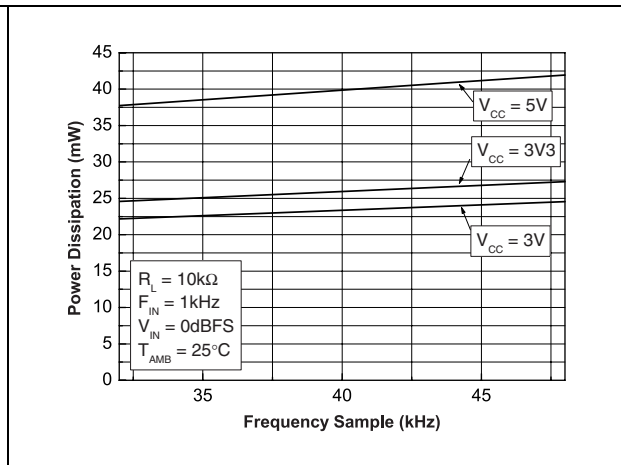

Figure 15. Power supply rejection ratio vs. frequency

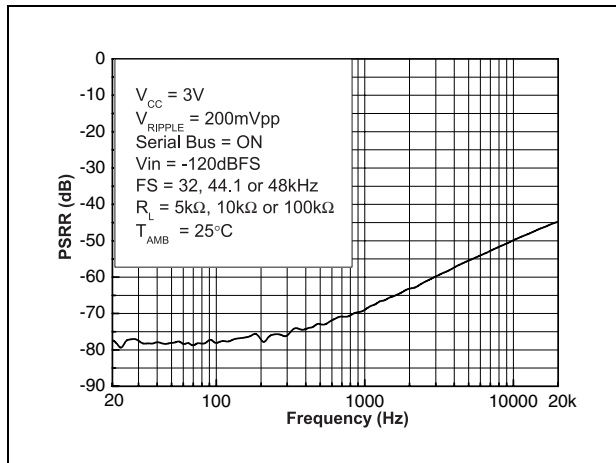

Figure 16. Power supply rejection ratio vs. frequency

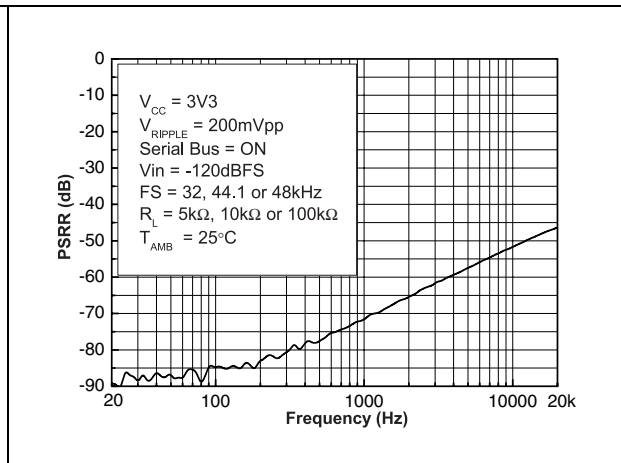

Figure 17. Power supply rejection ratio vs. frequency

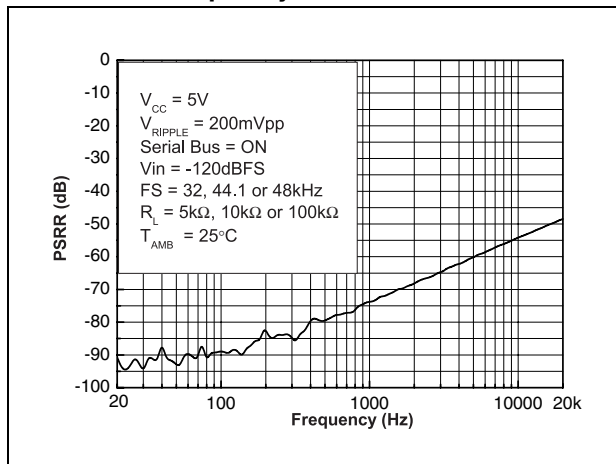

Figure 18. Signal to noise ratio vs. input level

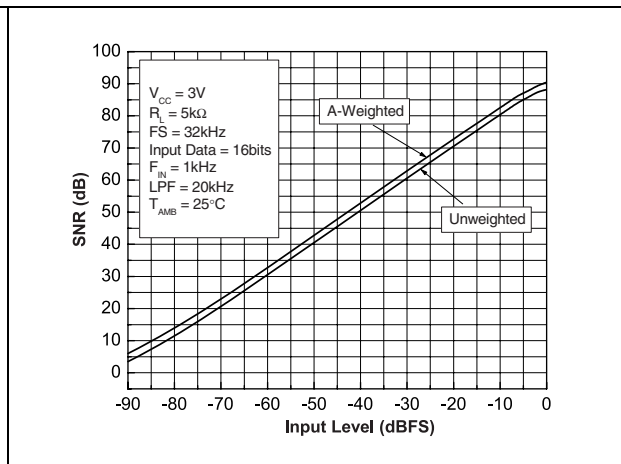

Figure 19. Signal to noise ratio vs. input level    Figure 20. Signal to noise ratio vs. input level

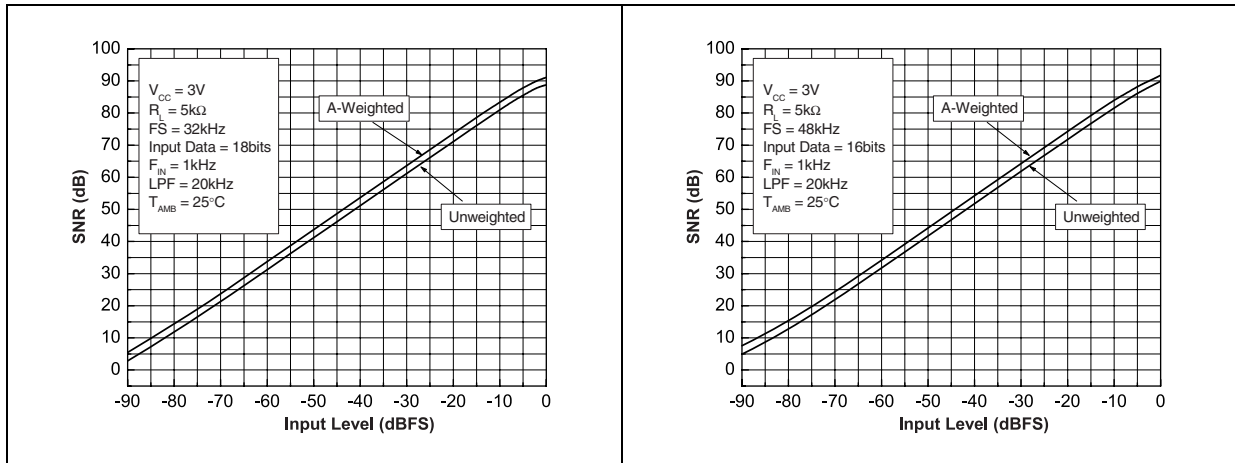

Figure 21. Signal to noise ratio vs. input level    Figure 22. Signal to noise ratio vs. input level

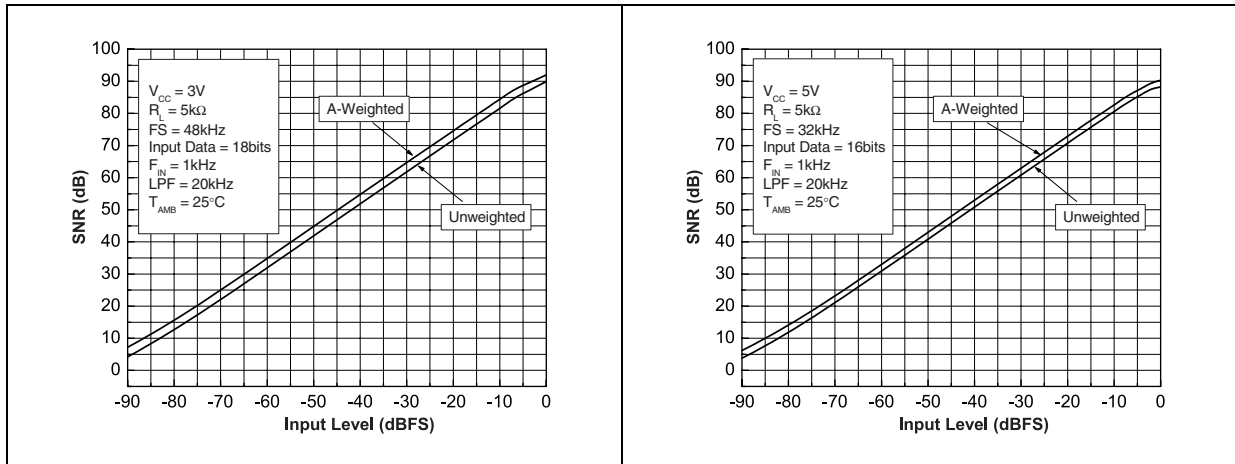

Figure 23. Signal to noise ratio vs. input level    Figure 24. Signal to noise ratio vs. input level

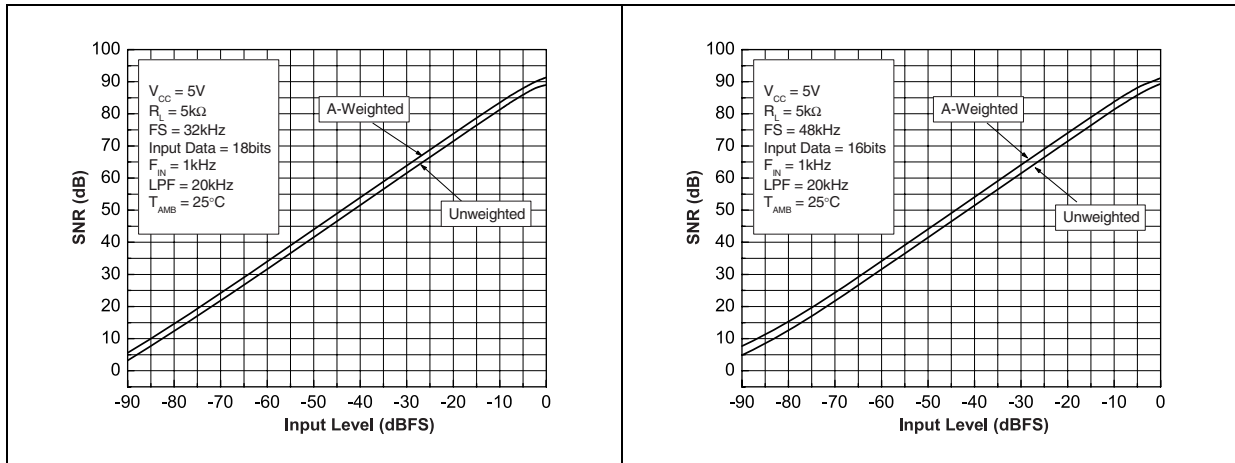

Figure 25. Signal to noise ratio vs. input level      Figure 26. Signal to noise ratio vs. input level

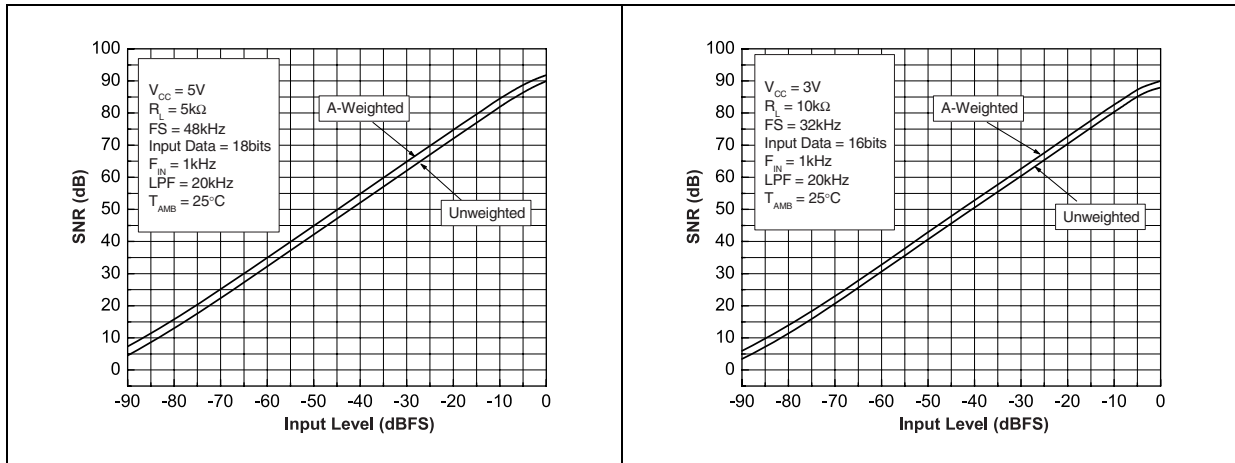

Figure 27. Signal to noise ratio vs. input level      Figure 28. Signal to noise ratio vs. input level

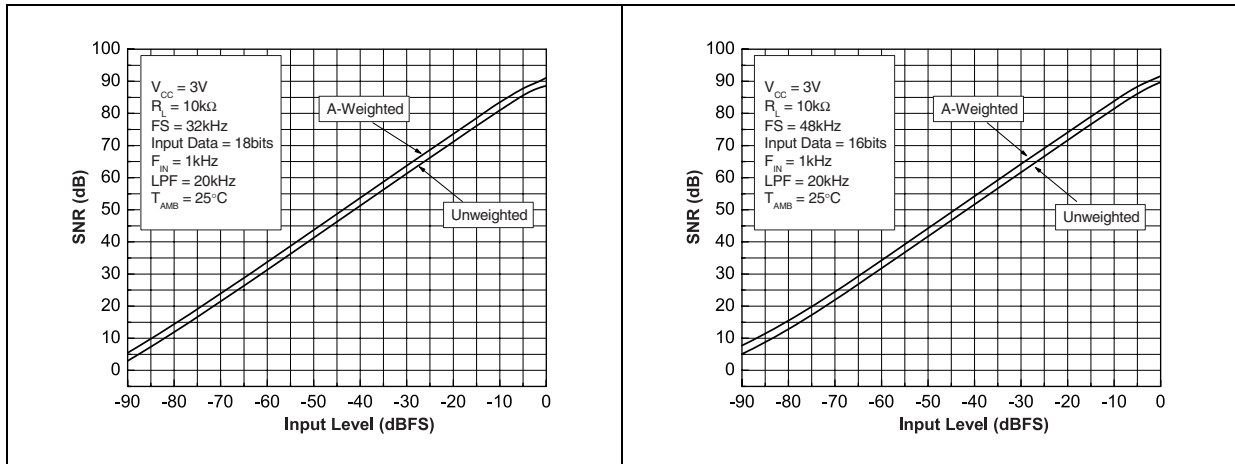

Figure 29. Signal to noise ratio vs. input level      Figure 30. Signal to noise ratio vs. input level

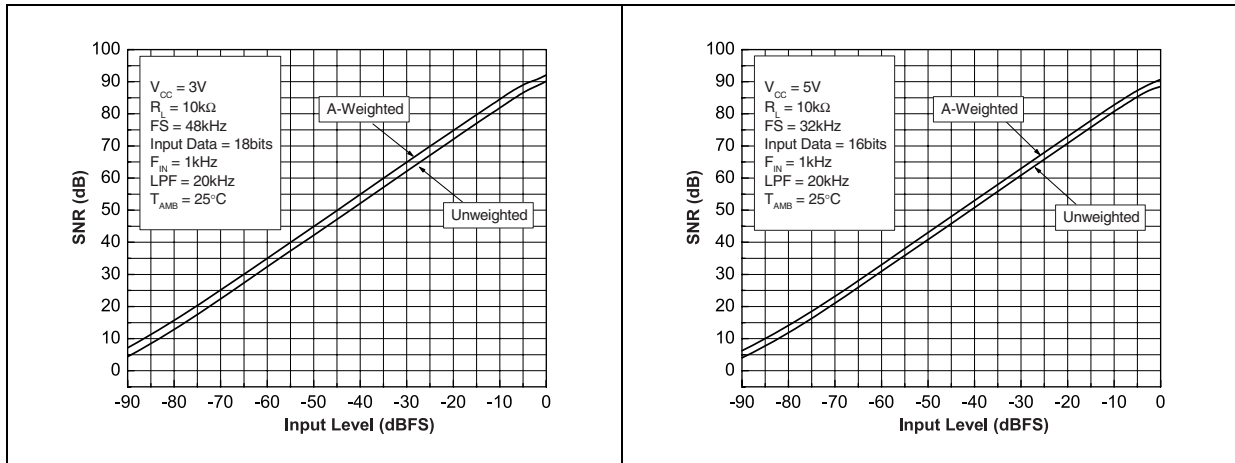

Figure 31. Signal to noise ratio vs. input level    Figure 32. Signal to noise ratio vs. input level

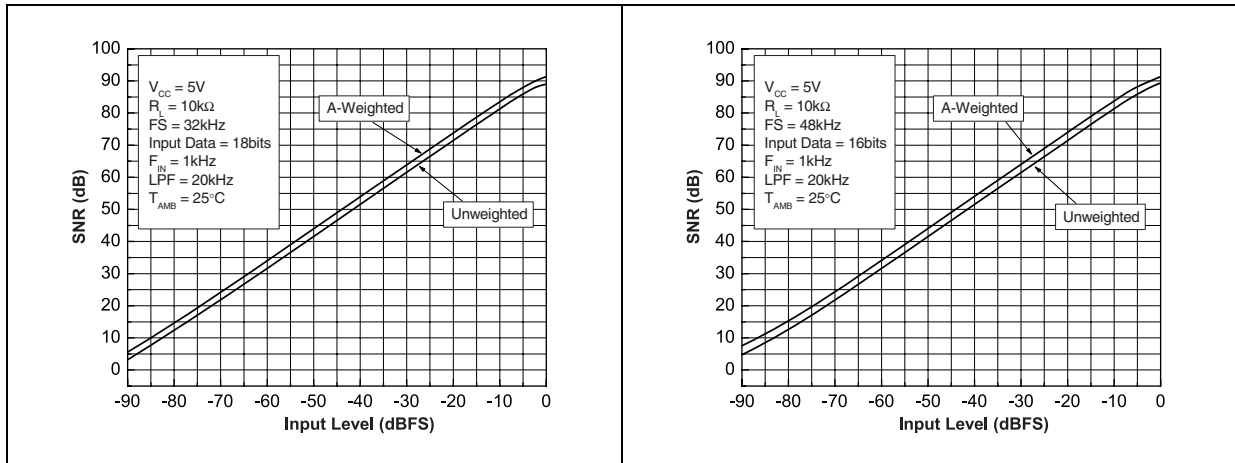

Figure 33. Signal to noise ratio vs. input level    Figure 34. Total harmonic distortion and noise vs. frequency

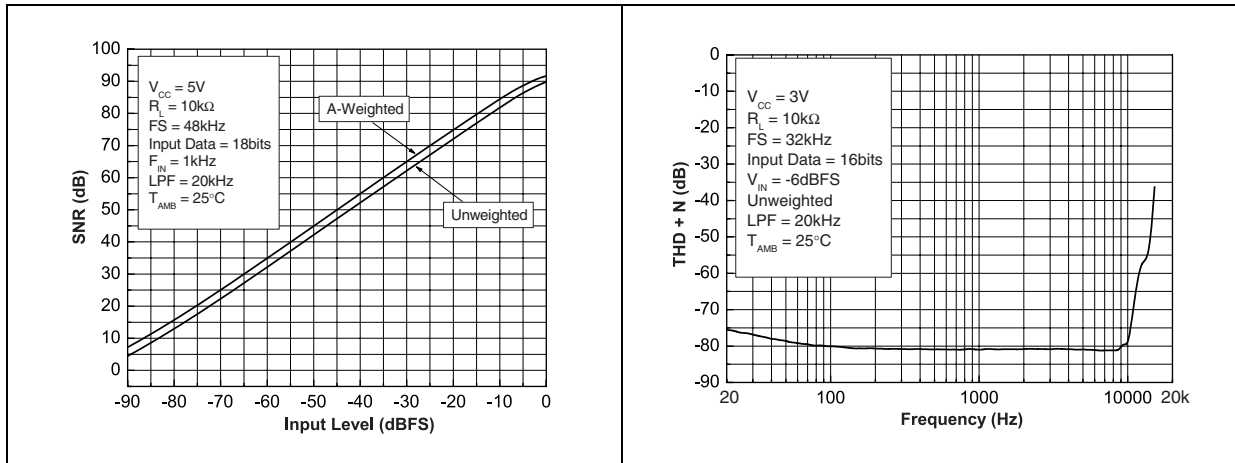
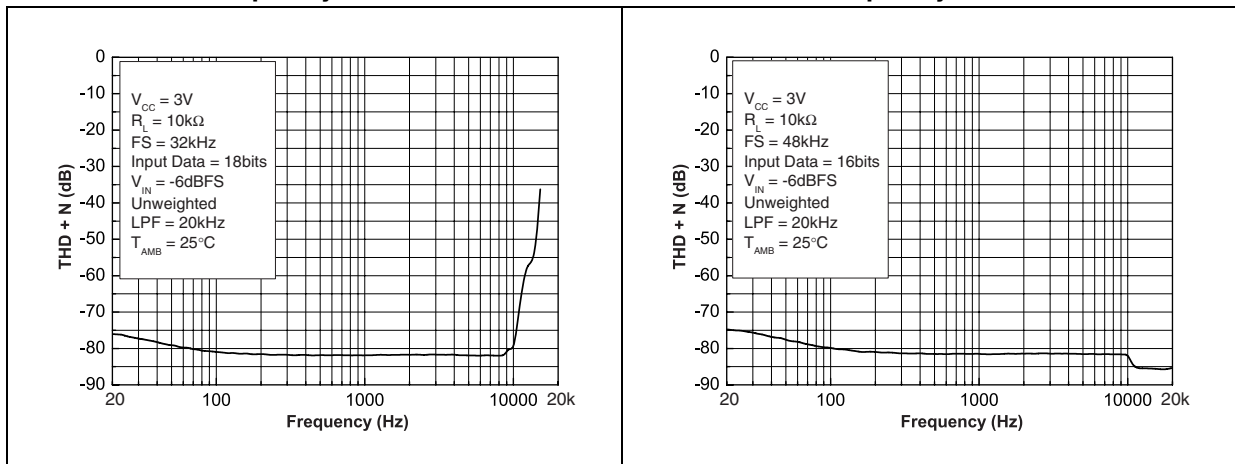
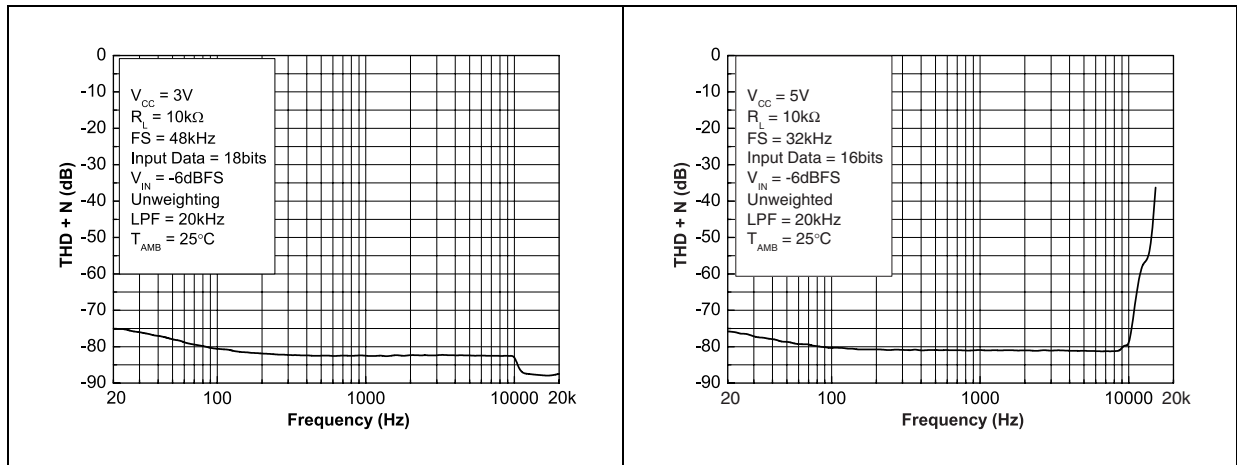

Figure 35. Total harmonic distortion and noise vs. frequency    Figure 36. Total harmonic distortion and noise vs. frequency

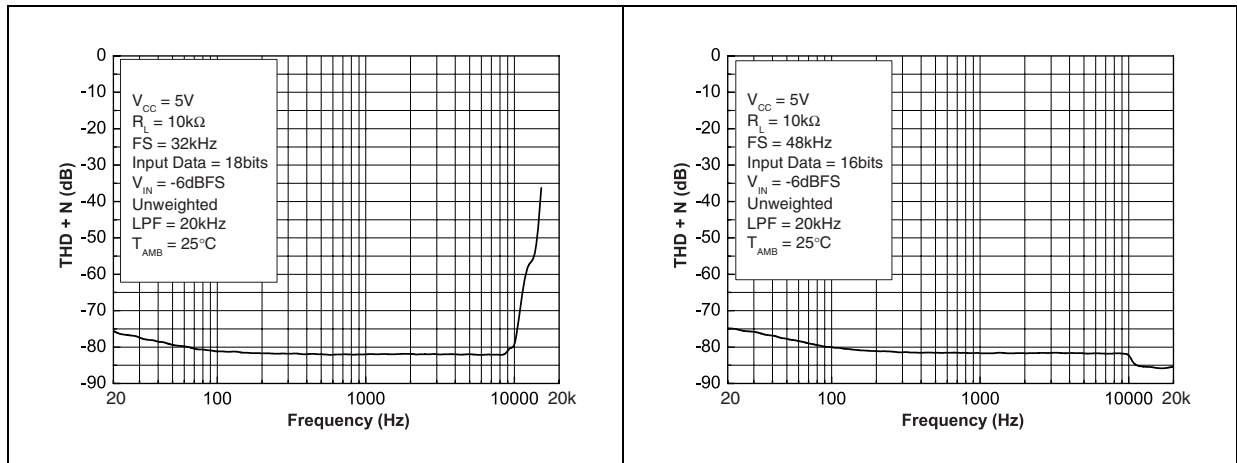



**Figure 37. Total harmonic distortion and noise vs. frequency** **Figure 38. Total harmonic distortion and noise vs. frequency**



**Figure 39. Total harmonic distortion and noise vs. frequency** **Figure 40. Total harmonic distortion and noise vs. frequency**



**Figure 41. Total harmonic distortion and noise vs. frequency** **Figure 42. Total harmonic distortion and noise vs. input level**

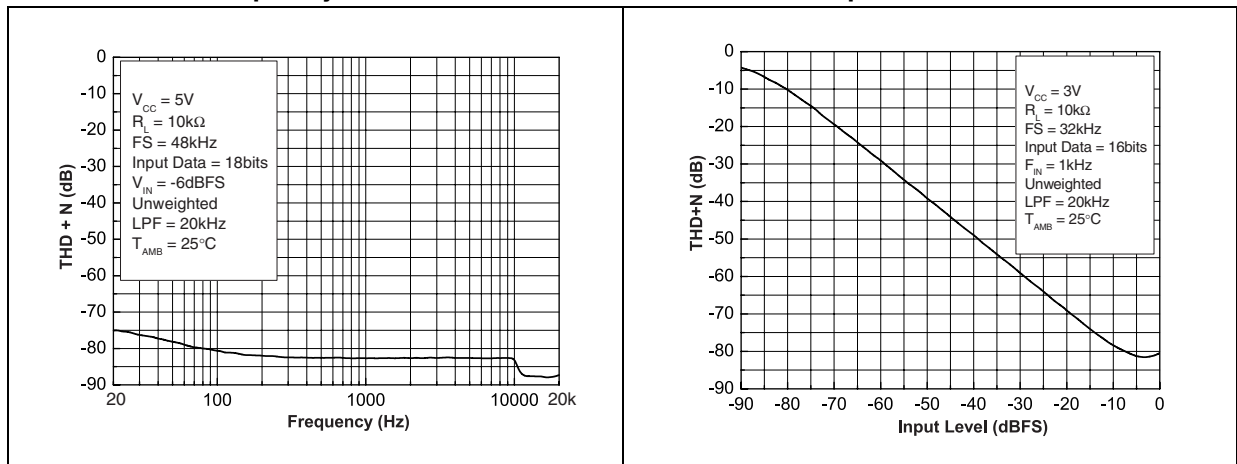

Figure 43. Total harmonic distortion and noise vs. input level

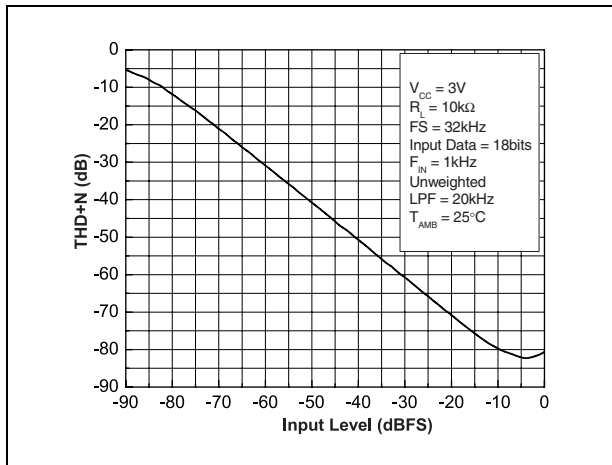

Figure 44. Total harmonic distortion and noise vs. input level

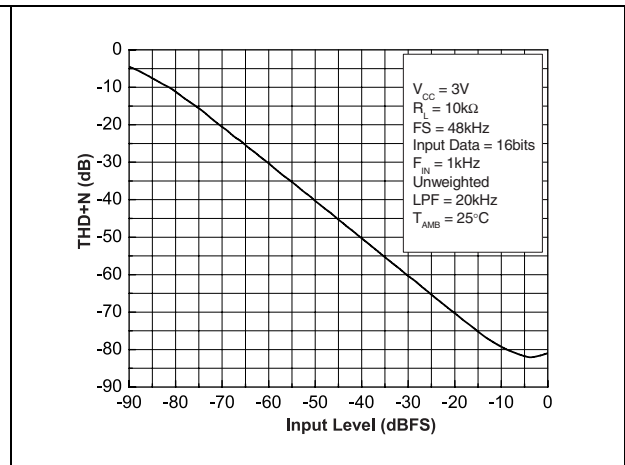

Figure 45. Total harmonic distortion and noise vs. input level

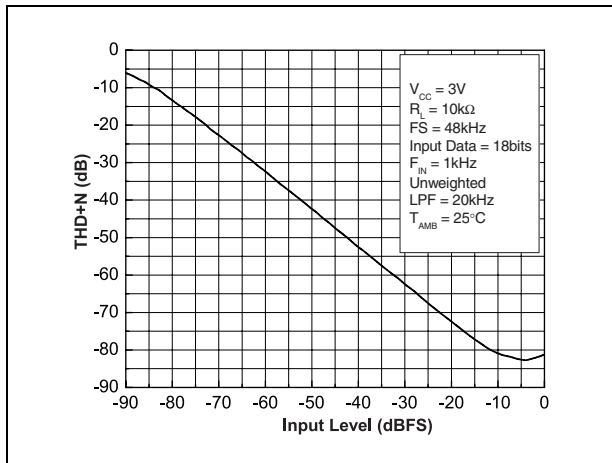

Figure 46. Total harmonic distortion and noise vs. input level

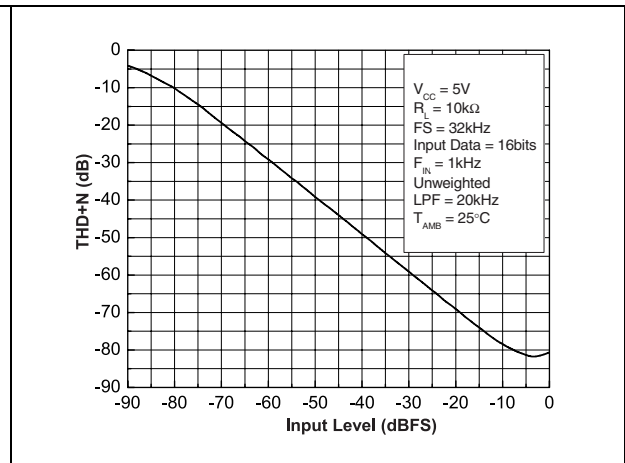

Figure 47. Total harmonic distortion and noise vs. input level

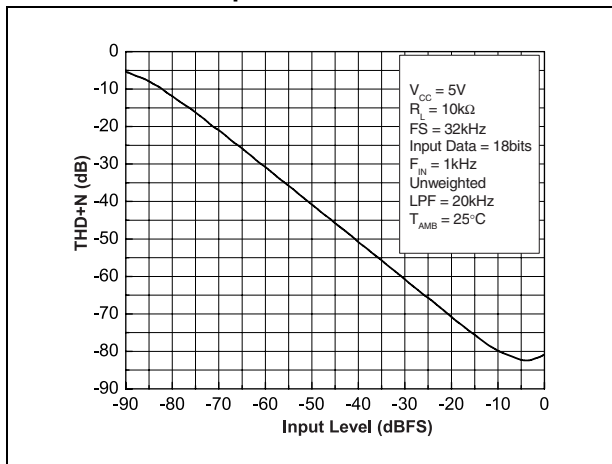

Figure 48. Total harmonic distortion and noise vs. input level

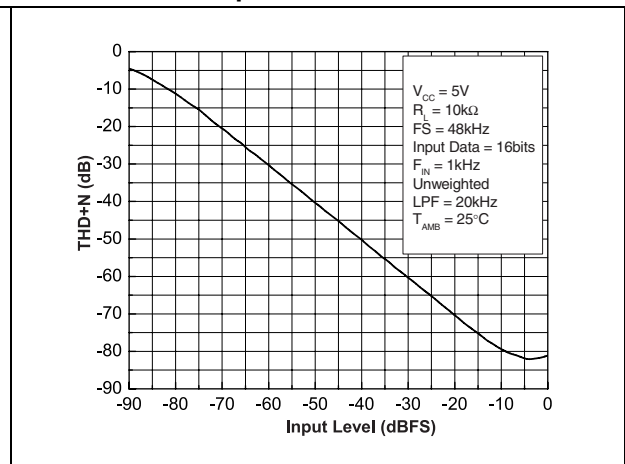
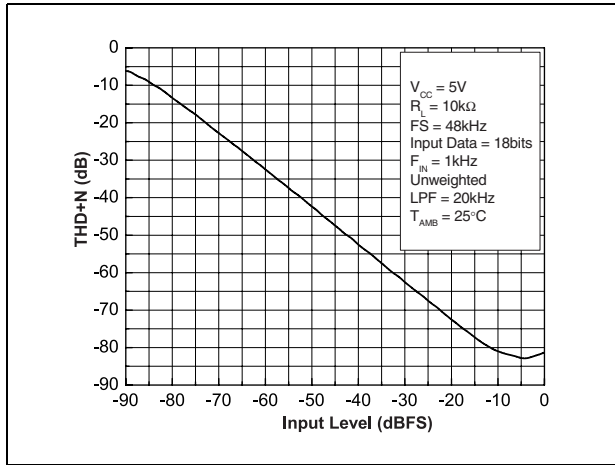

Figure 49. Total harmonic distortion and noise vs. input level



## 4 Application information

### 4.1 Serial audio interface

#### 4.1.1 Master clock and data clocks

Three external clock signals are applied to the TS4657. The MCLK is the external master clock applied by the audio data processor. The LRCLK is the channel frequency, also called LEFT/RIGHT clock, at which the digital words for each channel are input to the device. The LRCLK clock is the sample rate of the audio data. The ratio MCLK/LRCLK must be an integer as shown in [Table 9](#).

The BCLK is the bit clock and represents the clock at which the audio data is serially shifted into the audio port. BCLK is linked to LRCLK. The minimum required BCLK frequency is twice the audio sample rate times the number of bits in each audio word. Refer to [Table 10](#) for the BCLK/LRCLK ratio.

MCLK, LRCLK and BCLK must be synchronous clock signals.

**Table 9. Audio data sampling rates**

LRCLK (kHz)	MCLK (MHz)
	256x
32	8.192
44.1	11.2896
48	12.288

#### 4.1.2 Digital audio input format

The TS4657 receives serial digital audio data through a 3-wire interface. SDAT is the serial audio data input. The data is entered MSB first and is a two's complement. The data can be I<sup>2</sup>S, right or left justified. The data format is chosen with the control pins FORMAT1 and FORMAT2 as detailed in [Table 10](#).

[Figure 50 on page 20](#) summarizes the implementation of the audio data format.

**Table 10. Digital audio data formats supported by the TS4657**

FORMAT2	FORMAT1	Data Format	BCLK/LRCLK ratio	
			Min	Max
0	0	Right-justified, 16-bit data Data valid on rising edge of BCLK	32	256
0	1	Right-justified, 24-bit data Data valid on rising edge of BCLK	48	256
1	0	Left-Justified, 16-bit up to 24-bit data Data valid on rising edge of BCLK	2 x number of bits of data	256
1	1	I <sup>2</sup> S, 16-bit up to 24-bit data Data valid on rising edge of BCLK	2 x number of bits of data	256

Figure 50. Audio interface formats managed by the TS4657

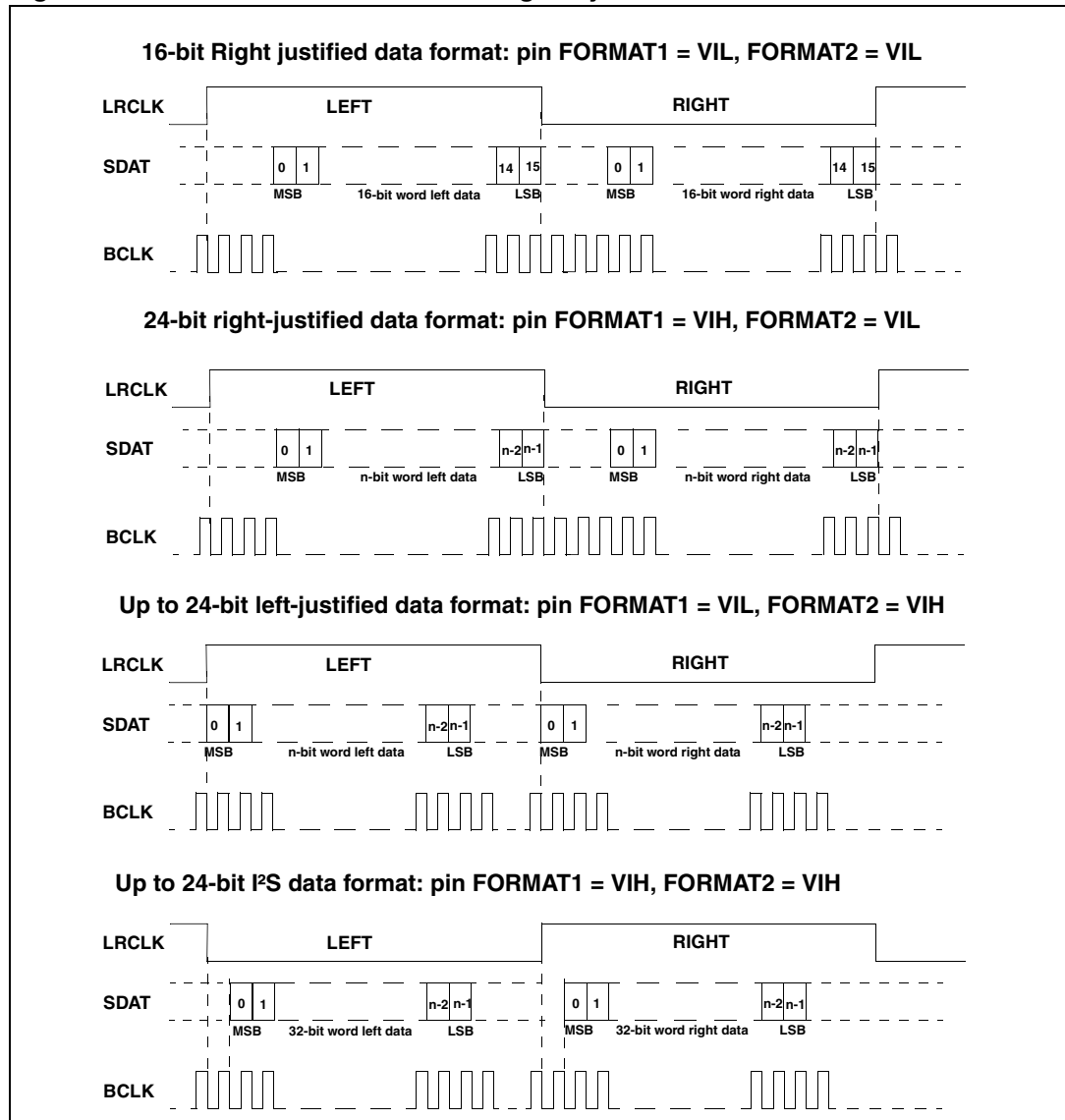

## 4.2 Power-management unit

The TS4657 utilizes a power-management unit to supply its internal structures.

A self-generated negative supply enables the drivers to be powered from positive and negative supplies, therefore increasing the amplitude of the output signal. This internal negative supply switches at a higher frequency than traditional architectures, derived from the master clock MCLK. This structure uses an original design that enables one to suppress the flying or floating capacitors. Therefore, only four small ceramic X5R 10V 1-μF decoupling capacitors are necessary for VCCA/VCCD and VREGA/VREGD.

Furthermore, the self-generated negative supply allows the amplifier outputs to be centered around zero, thus the bulky output coupling capacitors can be removed.

## 4.3 Recommended power-up and power-down sequences

### 4.3.1 Power-up

It is recommended to power-up the TS4657 prior to applying logical data in order to ensure correct ESD protection biasing.

When the  $\overline{\text{STDBY}}$  pin is in a low state (VIL,) the circuit is in standby; when the pin is in a high state (VIH), the circuit is enabled. An internal pull-down resistor will force the  $\overline{\text{STDBY}}$  pin to ground if no signal is applied to this pin.

The standby signal can be delayed from the power-up phase but simultaneous stimuli are possible, as shown in [Figure 51](#).

**Figure 51. Standby signal delayed from power-up phase**

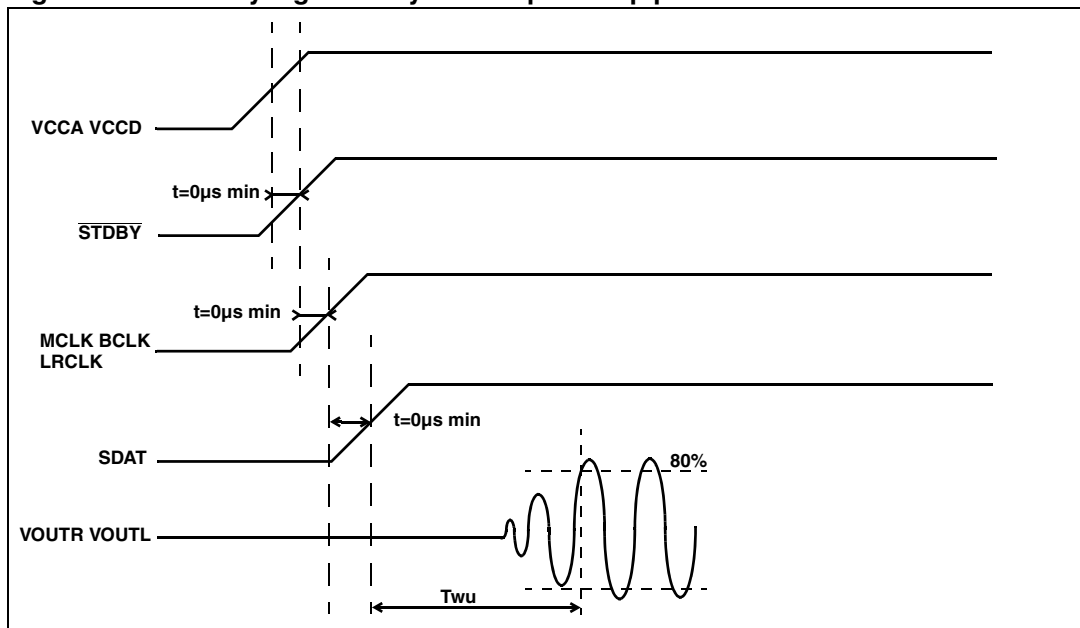

The wake-up time ( $T_{wu}$ ) of the TS4657 is defined as the time between the settlement of the digital input signals  $\overline{\text{STDBY}}$ , MCLK, BCLK, LRCLK, SDAT and 80% of the VOUTR/VOUTL amplitude. The  $T_{wu}$  of the circuit is typically 4.5 ms.

If all digital input signals are settled and an ON/OFF sequence is applied quickly on the  $\overline{\text{STDBY}}$  pin, the internal capacitors remain charged and the  $T_{wu}$  is around 1 ms.

### 4.3.2 Power-down

As described in [Section 4.2](#), the MCLK is internally used to supply some blocks. It is therefore recommended not to switch off the MCLK during normal operation.

To properly power-down the device, MCLK, BCLK and LRCLK should be switched off after the  $\overline{\text{STDBY}}$  signal.

The power-down time is very short and can be considered as zero.

## 5 Package information

In order to meet environmental requirements, ST offers these devices in different grades of ECOPACK<sup>®</sup> packages, depending on their level of environmental compliance. ECOPACK<sup>®</sup> specifications, grade definitions and product status are available at: [www.st.com](http://www.st.com). ECOPACK<sup>®</sup> is an ST trademark.

### 5.1 QFN20 package information

Figure 52. QFN20 package mechanical drawing

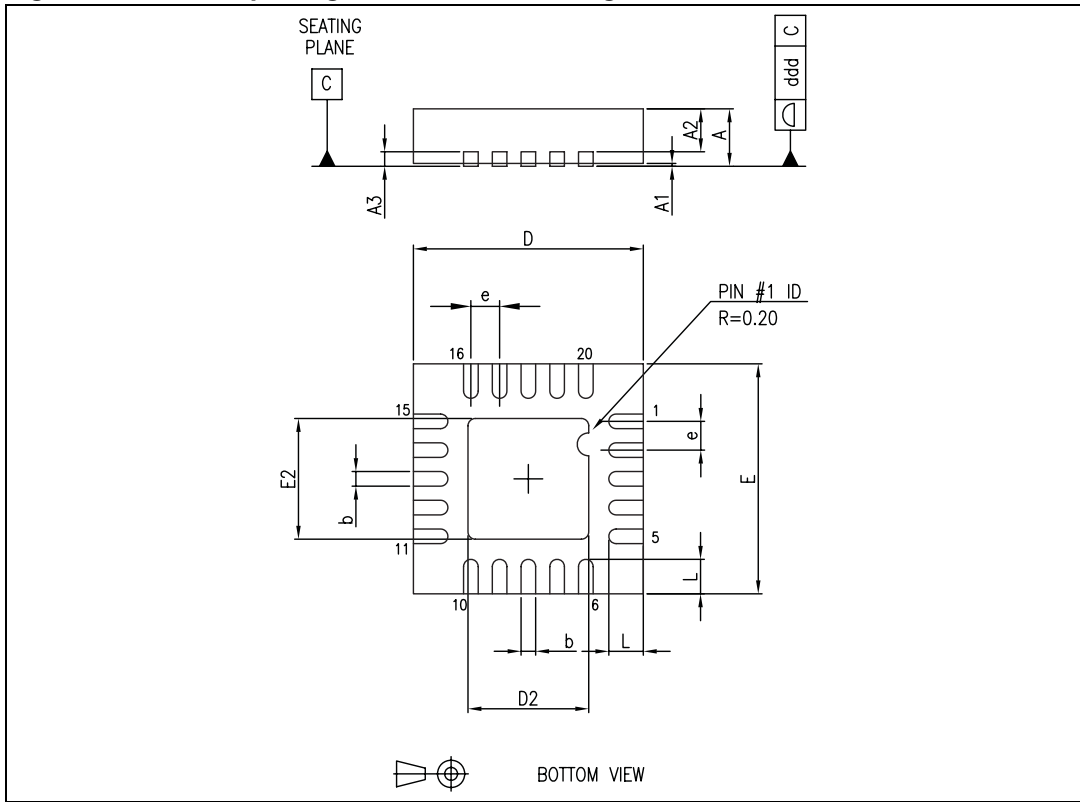

Table 11. QFN20 package mechanical data

Ref.	Dimensions					
	Millimeters			Inches		
	Min.	Typ.	Max.	Min.	Typ.	Max.
A	0.80	0.90	1.00	0.031	0.035	0.040
A1		0.02	0.05		0.0008	0.002
A2		0.65	1.00		0.026	0.040
A3		0.25			0.010	
b	0.18	0.23	0.30	0.007	0.009	0.012
D	3.85	4.00	4.15	0.152	0.157	0.163
D2	1.95	2.10	2.25	0.077	0.083	0.089
E	3.85	4.00	4.15	0.152	0.157	0.163
E2	1.95	2.10	2.25	0.077	0.083	0.089
e	0.45	0.50	0.55	0.018	0.020	0.022
L	0.35	0.55	0.75	0.014	0.022	0.030
ddd			0.08			0.003



## 6 Ordering information

**Table 12. Order codes**

<b>Order code</b>	<b>Temperature range</b>	<b>Package</b>	<b>Packing</b>	<b>Marking</b>
TS4657IQT	-40°C, +85°C	QFN20	Tape & reel	K657

## 7 Revision history

**Table 13. Document revision history**

Date	Revision	Changes
02-Mar-2009	1	Initial release.