



Chipsmall Limited consists of a professional team with an average of over 10 year of expertise in the distribution of electronic components. Based in Hongkong, we have already established firm and mutual-benefit business relationships with customers from,Europe,America and south Asia,supplying obsolete and hard-to-find components to meet their specific needs.

With the principle of “Quality Parts,Customers Priority,Honest Operation,and Considerate Service”,our business mainly focus on the distribution of electronic components. Line cards we deal with include Microchip,ALPS,ROHM,Xilinx,Pulse,ON,Everlight and Freescale. Main products comprise IC,Modules,Potentiometer,IC Socket,Relay,Connector.Our parts cover such applications as commercial,industrial, and automotives areas.

We are looking forward to setting up business relationship with you and hope to provide you with the best service and solution. Let us make a better world for our industry!



Contact us

Tel: +86-755-8981 8866 Fax: +86-755-8427 6832

Email & Skype: info@chipsmall.com Web: www.chipsmall.com

Address: A1208, Overseas Decoration Building, #122 Zhenhua RD., Futian, Shenzhen, China



Precision quad operational amplifier

Datasheet – production data

Features

- Low input offset voltage: 500 μ V max.
- Low power consumption
- Short-circuit protection
- Low distortion, low noise
- High gain bandwidth product
- High channel separation
- ESD protection 2 kV

Description

The TS514 device is a high-performance quad operational amplifier with frequency and phase compensation built into the chip. The internal phase compensation allows stable operation as a voltage follower in spite of its high gain bandwidth.

The circuit presents very stable electrical characteristics over the entire supply voltage range, and is particularly intended for professional and telecom applications (such as active filters, for example).

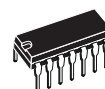

N
DIP14
(plastic package)

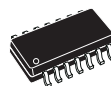

D
SO-14
(plastic micropackage)

Pin connections (top view)

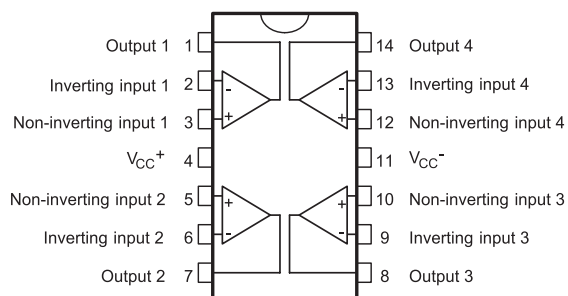

1 Absolute maximum ratings and operating conditions

Table 1. Absolute maximum ratings

Symbol	Parameter	Value	Unit
V_{CC}	Supply voltage	± 18	V
V_i	Input voltage	$V_{DD}-0.2$ to $V_{CC}+0.2$	V
$V_{id}^{(1)}$	Differential input voltage	$\pm V_{CC}$	V
T_{stg}	Storage temperature range	-65 to +150	°C
R_{thja}	Thermal resistance junction-to-ambient		
	SO-14 DIP14	103 80	°C/W
R_{thjc}	Thermal resistance junction-to-case		
	SO-14 DIP14	31 33	°C/W
ESD	HBM: human body model ⁽²⁾	2	kV
	MM: machine model ⁽³⁾	200	V
	CDM: charged device model ⁽⁴⁾	1.5	kV

- Differential voltages are the non-inverting input terminal with respect to the inverting input terminal.
- Human body model: a 100 pF capacitor is charged to the specified voltage, then discharged through a 1.5k Ω resistor between two pins of the device. This is done for all couples of connected pin combinations while the other pins are floating.
- Machine model: a 200 pF capacitor is charged to the specified voltage, then discharged directly between two pins of the device with no external series resistor (internal resistor < 5 Ω). This is done for all couples of connected pin combinations while the other pins are floating.
- Charged device model: all pins and the package are charged together to the specified voltage and then discharged directly to ground through only one pin. This is done for all pins.

Table 2. Operating conditions

Symbol	Parameter	Value	Unit
V_{CC}	Supply voltage	6 to 30	V
V_{icm}	Common mode input voltage range	$V_{DD}+0.8$ to $V_{CC}-1.5$	V
T_{oper}	Operating free air temperature range	-40 to +125	°C

2 Schematic diagram

Figure 1. Typical schematic diagram (1/4 TS514)

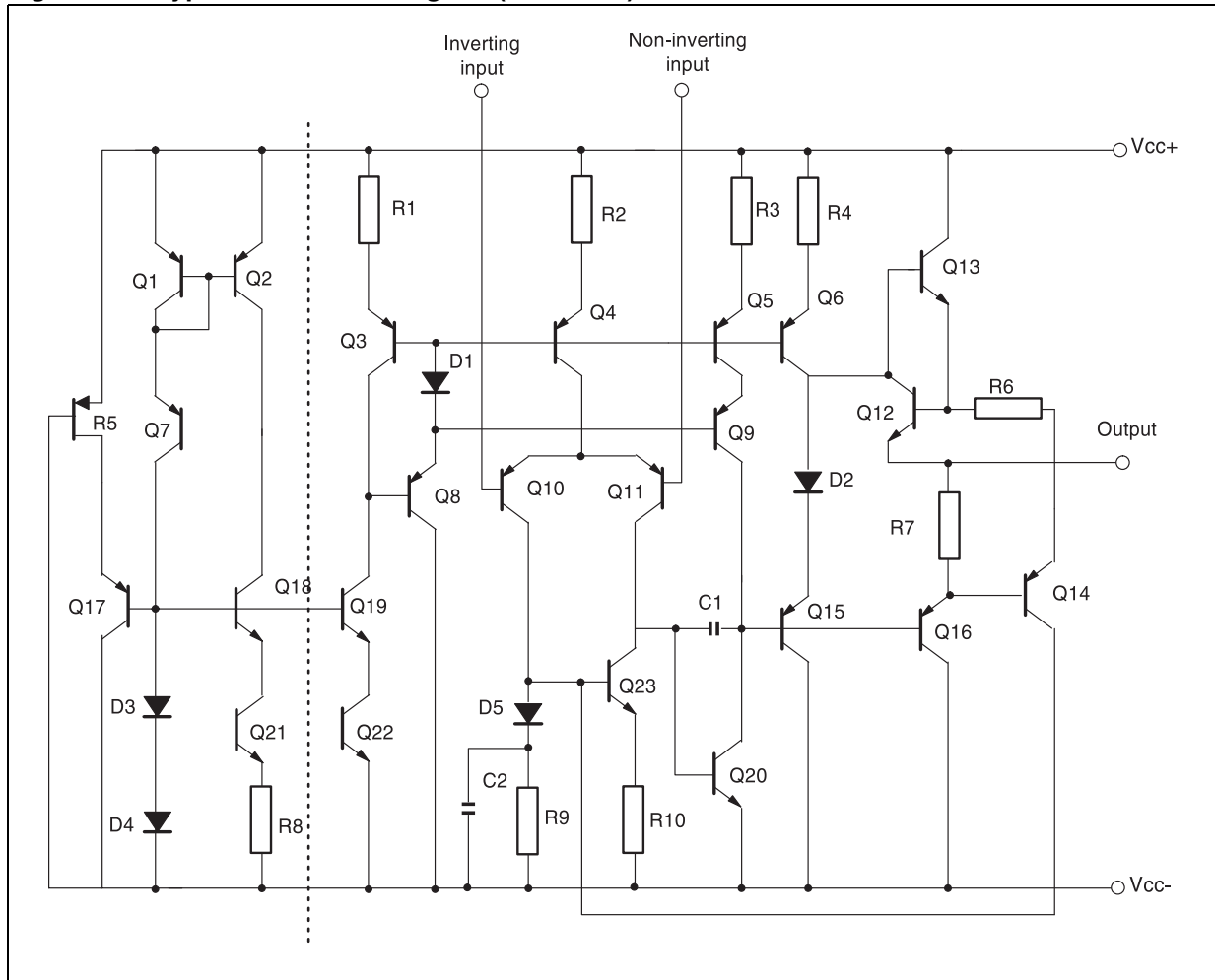

3 Electrical characteristics

Table 3. Electrical characteristics at $V_{CC} = \pm 15\text{ V}$, $T_{amb} = 25\text{ °C}$ (unless otherwise specified)

Symbol	Parameter	Min.	Typ.	Max.	Unit
I_{CC}	Supply current (per operator) at $T_{min} \leq T_{op} \leq T_{max}$		0.5	0.6 0.75	mA
I_{ib}	Input bias current – at 25 °C – at $T_{min} \leq T_{op} \leq T_{max}$		50	150 300	nA
R_i	Input resistance, $F = 1\text{ kHz}$		1		M Ω
V_{io}	Input offset voltage – at 25 °C TS514 TS514A – at $T_{min} \leq T_{op} \leq T_{max}$ TS514 TS514A		0.5	2.5 0.5 4 1.5	mV
ΔV_{io}	Input offset voltage drift at $T_{min} \leq T_{op} \leq T_{max}$		5		$\mu\text{V}/\text{°C}$
I_{io}	Input offset current at 25 °C at $T_{min} \leq T_{op} \leq T_{max}$		5	20 40	nA
ΔI_{io}	Input offset current drift $T_{min} \leq T_{op} \leq T_{max}$		0.08		$\frac{\text{nA}}{\text{°C}}$
I_{os}	Output short-circuit current		23		mA
A_{vd}	Large signal voltage gain, $R_L = 2\text{ k}\Omega$ $V_{CC} = \pm 15\text{ V}$, at $T_{min} \leq T_{op} \leq T_{max}$ $V_{CC} = \pm 4\text{ V}$	90	100 95		dB
GBP	Gain bandwidth product, $F = 100\text{ kHz}$	1.8	3		MHz
e_n	Equivalent input noise voltage, $F = 1\text{ kHz}$ $R_s = 50\ \Omega$ $R_s = 1\text{ k}\Omega$ $R_s = 10\text{ k}\Omega$		8 10 18	15	$\frac{\text{nV}}{\sqrt{\text{Hz}}}$
THD	Total harmonic distortion $A_v = 20\text{ dB}$, $R_L = 2\text{ k}\Omega$, $V_o = 2\text{ V}_{pp}$, $f = 1\text{ kHz}$		0.03	0.1	%
$\pm V_{opp}$	Output voltage swing, $R_L = 2\text{ k}\Omega$ $V_{CC} = \pm 15\text{ V}$, at $T_{min} \leq T_{op} \leq T_{max}$ $V_{CC} = \pm 4\text{ V}$	± 13	± 3		V
V_{opp}	Large signal voltage swing, $R_L = 10\text{ k}\Omega$, $F = 10\text{ kHz}$		28		V_{pp}
SR	Slew rate, unity gain, $R_L = 2\text{ k}\Omega$	0.8	1.5		V/ μs

**Table 3. Electrical characteristics at $V_{CC} = \pm 15\text{ V}$, $T_{amb} = 25\text{ °C}$
(unless otherwise specified) (continued)**

Symbol	Parameter	Min.	Typ.	Max.	Unit
CMR	Common mode rejection ratio $CMR = 20 \log (\Delta V_{ic} / \Delta V_{io})$ $(V_{ic} = -10\text{ V to } 10\text{ V}, V_{out} = V_{CC}/2, R_L > 1\text{ M}\Omega)$	90			dB
SVR	Supply voltage rejection ratio $20 \log (\Delta V_{CC} / \Delta V_{io})$ $(V_{CC} = \pm 5\text{ V to } \pm 15\text{ V}, V_{out} = V_{icm} = V_{CC}/2)$	90			dB
V_{o1}/V_{o2}	Channel separation, $F = 1\text{ kHz}$		120		dB

Figure 2. V_{io} distribution at $V_{CC} = \pm 15\text{ V}$ and $T = 25\text{ }^\circ\text{C}$

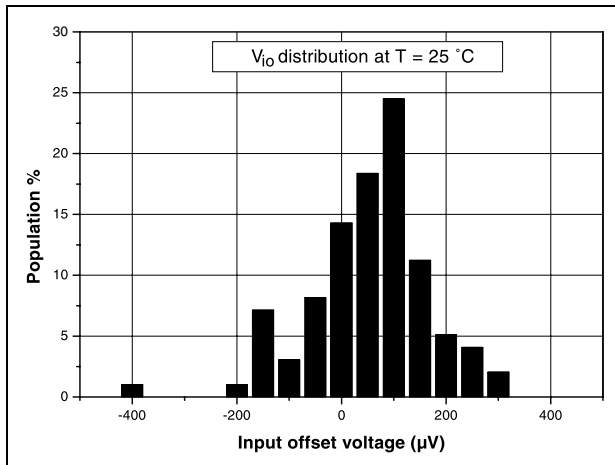

Figure 3. V_{io} distribution at $V_{CC} = \pm 15\text{ V}$ and $T = 125\text{ }^\circ\text{C}$

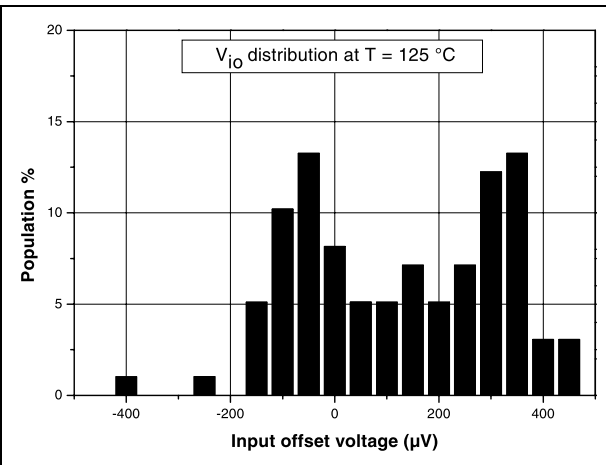

Figure 4. Input offset voltage vs. supply voltage at $V_{icm} = V_{CC}/2$

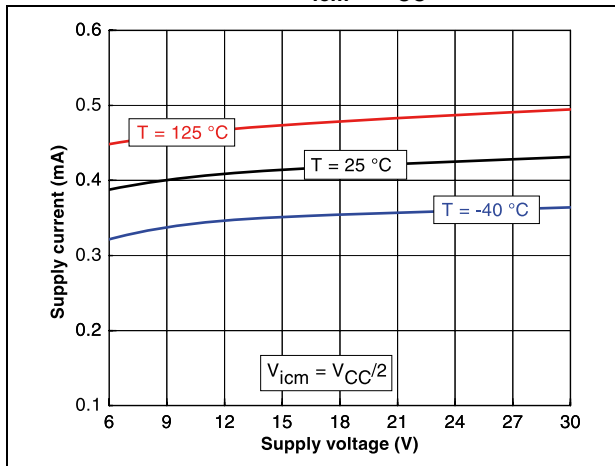

Figure 5. Input offset voltage vs. input common mode voltage at $V_{CC} = 6\text{ V}$

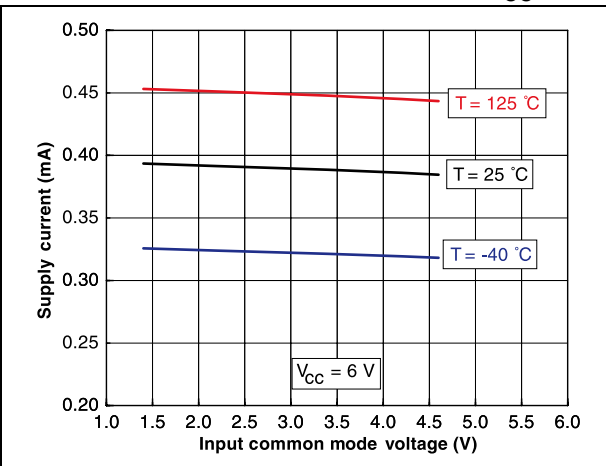

Figure 6. Input offset voltage vs. input common mode voltage at $V_{CC} = 10\text{ V}$

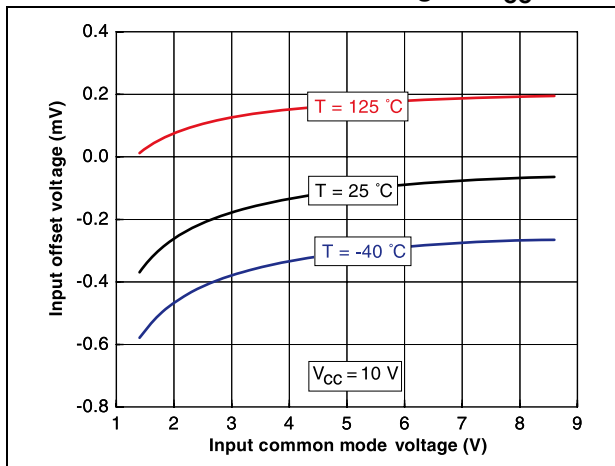

Figure 7. Input offset voltage vs. input common mode voltage at $V_{CC} = 30\text{ V}$

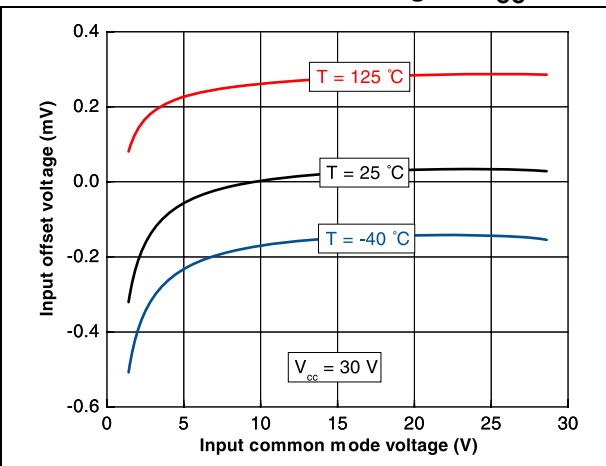

Figure 8. Supply current (per operator) vs. supply voltage at $V_{icm} = V_{CC}/2$

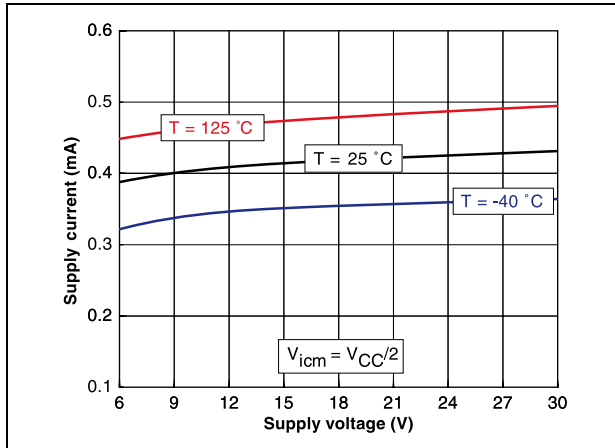

Figure 9. Supply current (per operator) vs. input common mode voltage at $V_{CC} = 6 V$

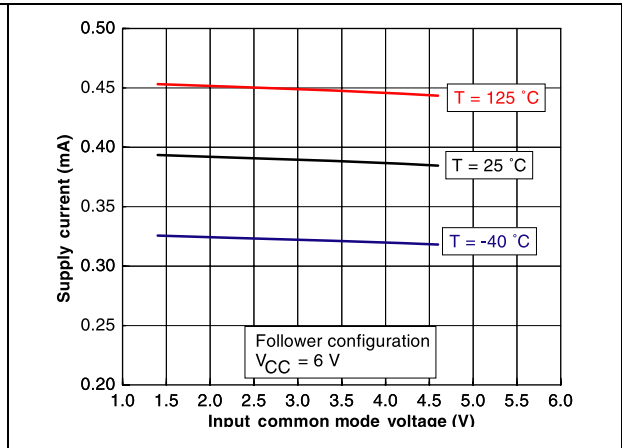

Figure 10. Supply current (per operator) vs. input common mode voltage at $V_{CC} = 10 V$

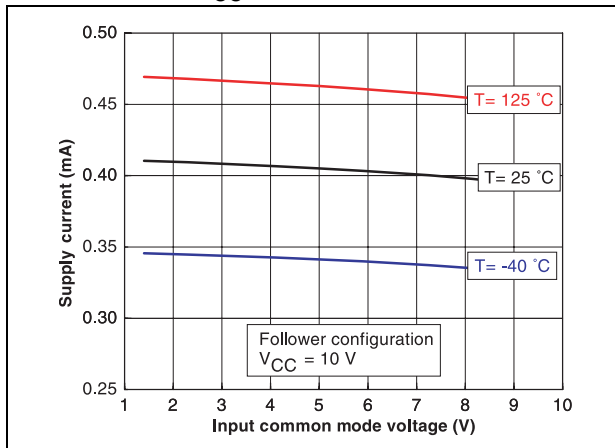

Figure 11. Supply current (per operator) vs. input common mode voltage at $V_{CC} = 30 V$

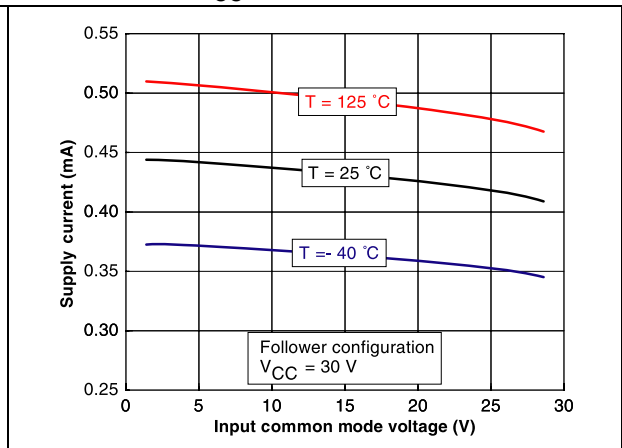

Figure 12. Output current vs. supply voltage at $V_{icm} = V_{CC}/2$

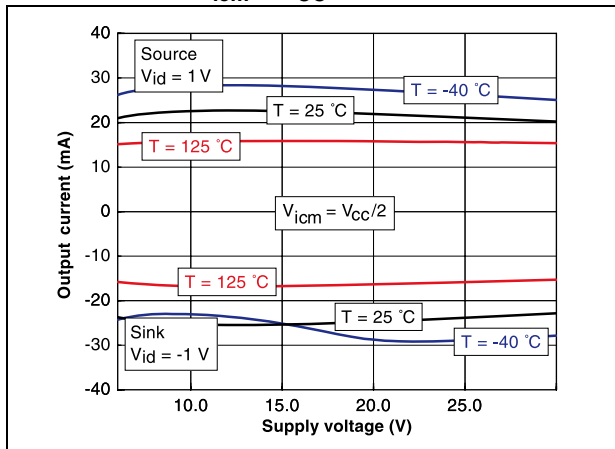

Figure 13. Output current vs. output voltage at $V_{CC} = 6 V$

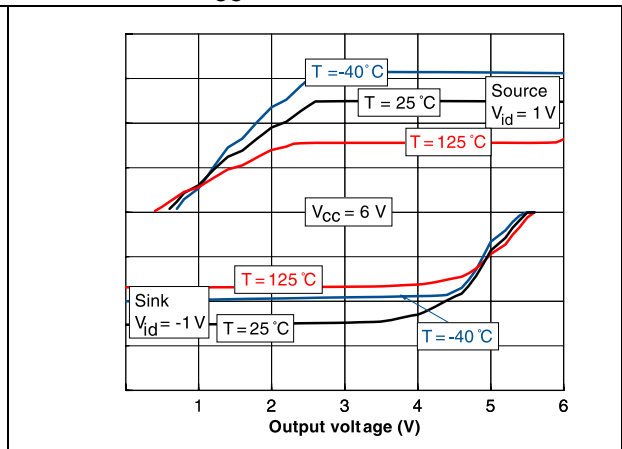

Figure 14. Output current vs. output voltage at $V_{CC} = 10\text{ V}$

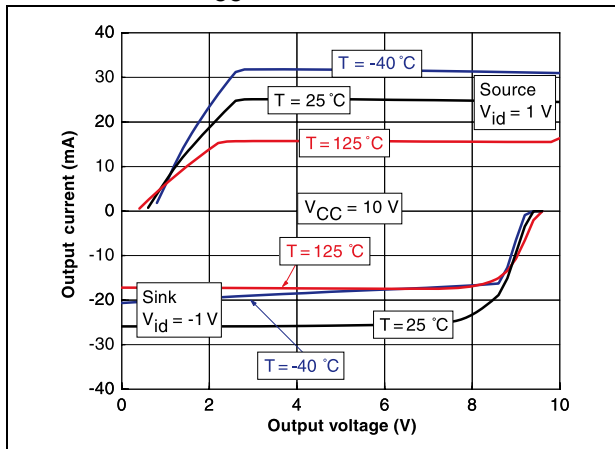

Figure 15. Output current vs. output voltage at $V_{CC} = 30\text{ V}$

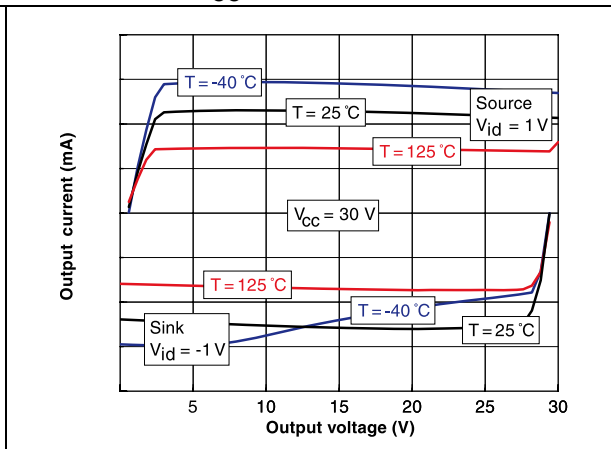

Figure 16. Voltage gain and phase for different capacitive load at $V_{CC} = 6\text{ V}$, $V_{icm} = 3\text{ V}$ and $T = 25\text{ °C}$

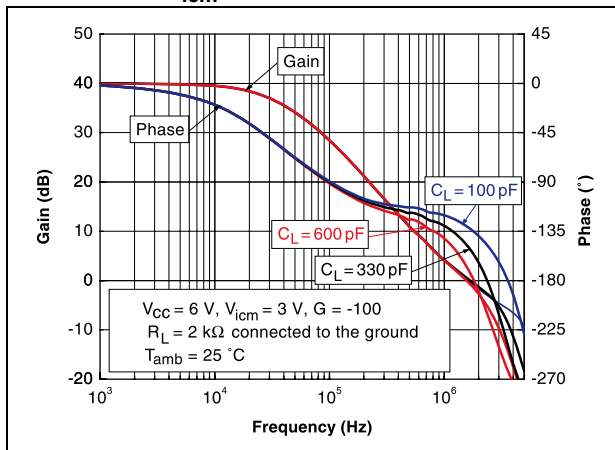

Figure 17. Voltage gain and phase for different capacitive load at $V_{CC} = 10\text{ V}$, $V_{icm} = 5\text{ V}$ and $T = 25\text{ °C}$

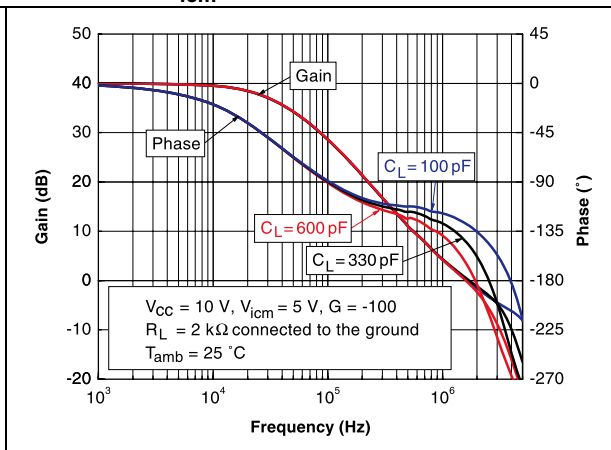

Figure 18. Voltage gain and phase for different capacitive load at $V_{CC} = 30\text{ V}$, $V_{icm} = 15\text{ V}$ and $T = 25\text{ °C}$

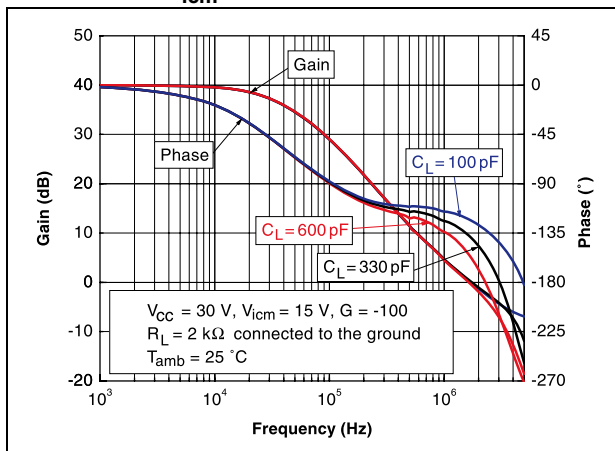

Figure 19. Frequency response for different capacitive load at $V_{CC} = 6\text{ V}$, $V_{icm} = 3\text{ V}$ and $T = 25\text{ °C}$

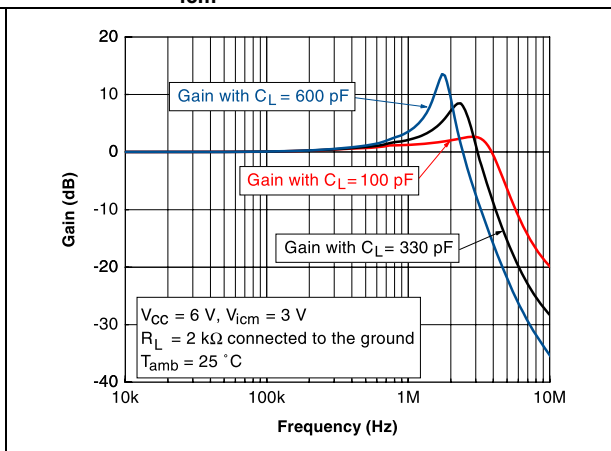

Figure 20. Frequency response for different capacitive load at $V_{CC} = 10\text{ V}$, $V_{icm} = 5\text{ V}$ and $T = 25\text{ }^\circ\text{C}$

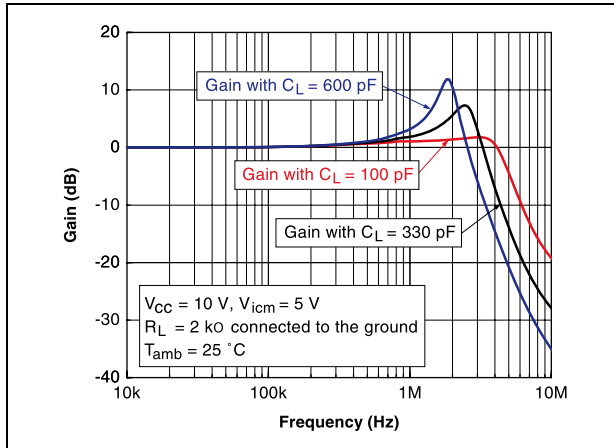

Figure 21. Frequency response for different capacitive load at $V_{CC} = 30\text{ V}$, $V_{icm} = 15\text{ V}$ and $T = 25\text{ }^\circ\text{C}$

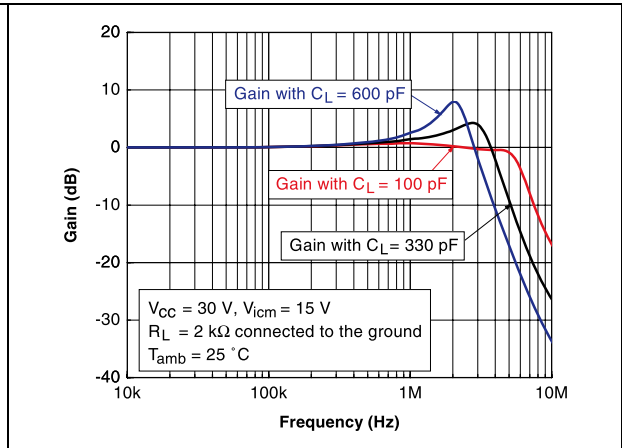

Figure 22. Gain margin vs. output current, at $V_{CC} = 6\text{ V}$, $V_{icm} = 3\text{ V}$ and $T = 25\text{ }^\circ\text{C}$

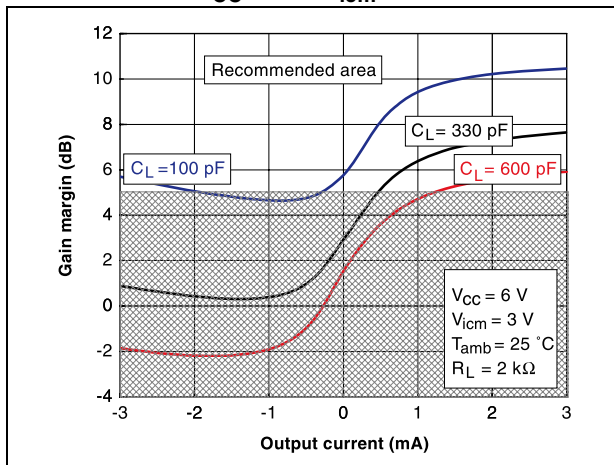

Figure 23. Gain margin vs. output current, at $V_{CC} = 10\text{ V}$, $V_{icm} = 5\text{ V}$ and $T = 25\text{ }^\circ\text{C}$

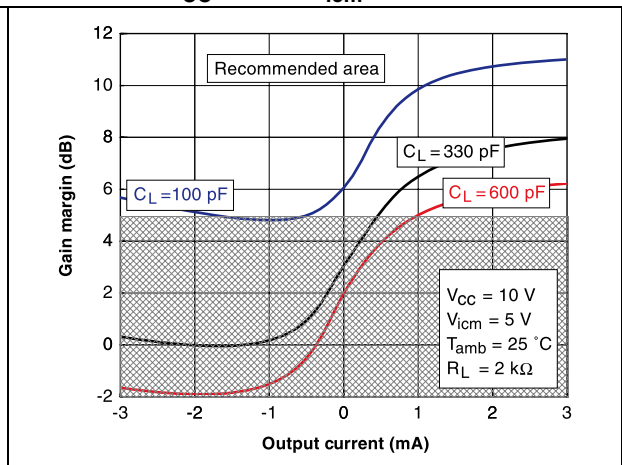

Figure 24. Gain margin vs. output current, at $V_{CC} = 30\text{ V}$, $V_{icm} = 15\text{ V}$ and $T = 25\text{ }^\circ\text{C}$

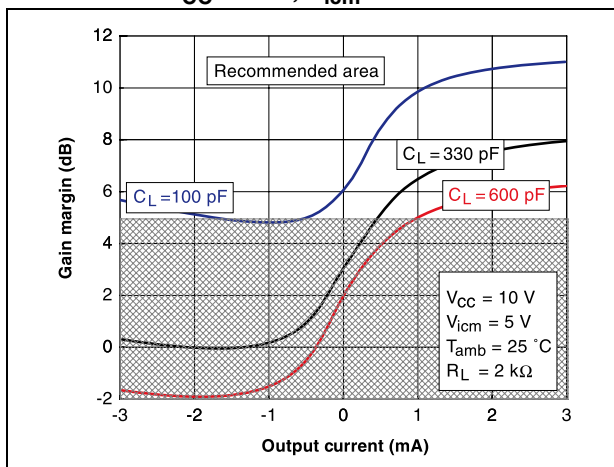

Figure 25. Phase margin vs. output current, at $V_{CC} = 6\text{ V}$, $V_{icm} = 3\text{ V}$ and $T = 25\text{ }^\circ\text{C}$

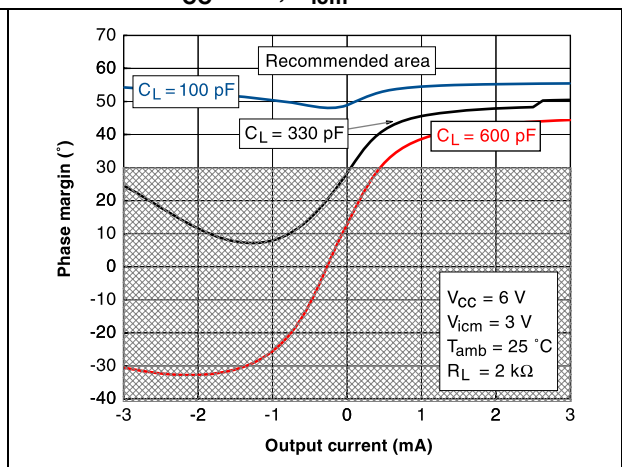

Figure 26. Phase margin vs. output current, at $V_{CC} = 10\text{ V}$, $V_{icm} = 5\text{ V}$ and $T = 25\text{ }^\circ\text{C}$

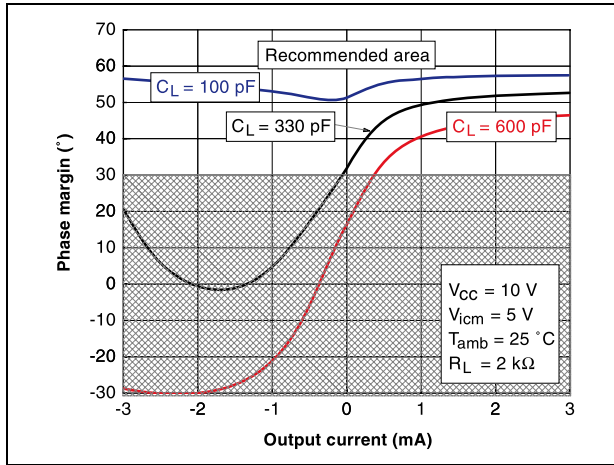
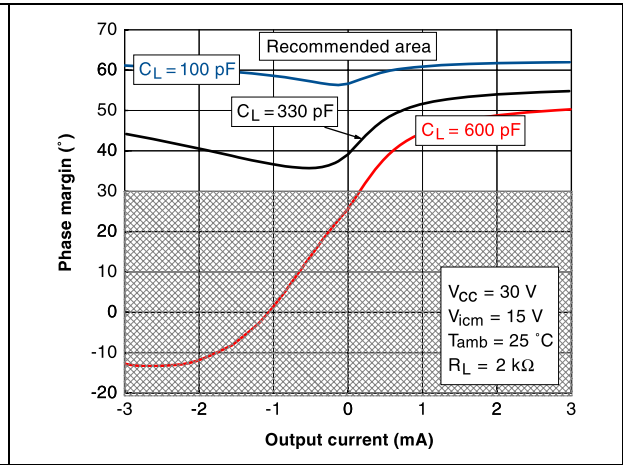

Figure 27. Phase margin vs. output current, at $V_{CC} = 30\text{ V}$, $V_{icm} = 15\text{ V}$ and $T = 25\text{ }^\circ\text{C}$



4 Package information

In order to meet environmental requirements, ST offers these devices in different grades of ECOPACK® packages, depending on their level of environmental compliance. ECOPACK specifications, grade definitions and product status are available at: www.st.com. ECOPACK is an ST trademark.

4.1 DIP14 package information

Figure 28. DIP14 package outline

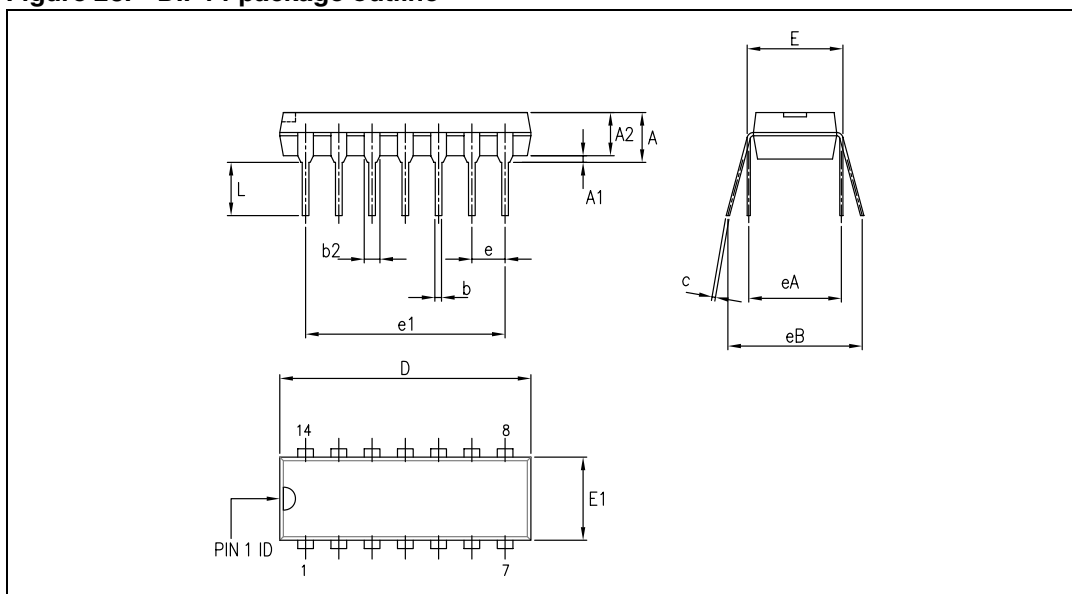

Table 4. DIP14 package mechanical data

Symbol	Dimensions					
	Millimeters			Inches		
	Min.	Typ.	Max.	Min.	Typ.	Max.
A			5.33			0.21
A1	0.38			0.015		
A2	2.92	3.30	4.95	0.11	0.13	0.19
b	0.36	0.46	0.56	0.014	0.018	0.022
b2	1.14	1.52	1.78	0.04	0.06	0.07
c	0.20	0.25	0.36	0.007	0.009	0.01
D	18.67	19.05	19.69	0.73	0.75	0.77
E	7.62	7.87	8.26	0.30	0.31	0.32
E1	6.10	6.35	7.11	0.24	0.25	0.28
e		2.54			0.10	
e1		15.24			0.60	
eA		7.62			0.30	
eB			10.92			0.43
L	2.92	3.30	3.81	0.11	0.13	0.15

Note: *D and E1 dimensions do not include mold flash or protrusions. Mold flash or protrusions shall not exceed 0.25 mm.*

4.2 SO-14 package information

Figure 29. SO-14 package outline

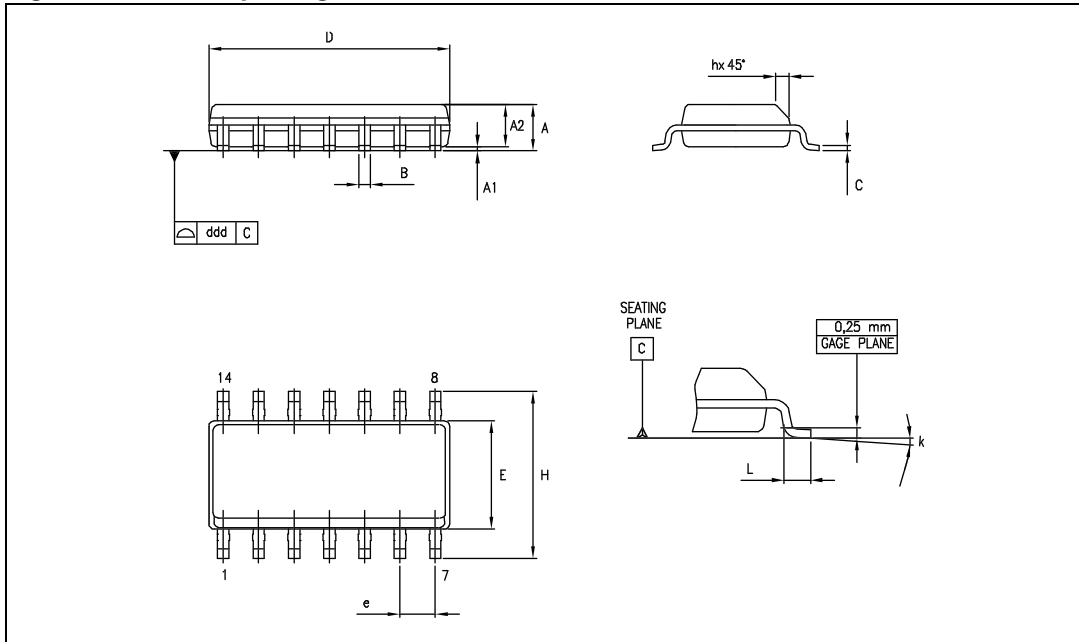

Table 5. SO-14 package mechanical data

Symbol	Dimensions					
	Millimeters			Inches		
	Min.	Typ.	Max.	Min.	Typ.	Max.
A	1.35		1.75	0.05		0.068
A1	0.10		0.25	0.004		0.009
A2	1.10		1.65	0.04		0.06
B	0.33		0.51	0.01		0.02
C	0.19		0.25	0.007		0.009
D	8.55		8.75	0.33		0.34
E	3.80		4.0	0.15		0.15
e		1.27			0.05	
H	5.80		6.20	0.22		0.24
h	0.25		0.50	0.009		0.02
L	0.40		1.27	0.015		0.05
k	8° (max.)					
ddd			0.10			0.004

Note: D and F dimensions do not include mold flash or protrusions. Mold flash or protrusions must not exceed 0.15 mm.

5 Ordering information

Table 6. Order codes

Order code	Temperature range	Package	Packaging	Marking
TS514IN	-40, + 125 °C	DIP14	Tube	TS514IN
TS514AIN				TS514AIN
TS514ID TS514IDT		SO-14	Tube or tape and reel	514I
TS514AID TS514AIDT				514AI

6 Revision history

Table 7. Document revision history

Date	Revision	Changes
09-Mar-2001	1	Initial release.
23-Jun-2005	2	Automotive grade part references inserted in the datasheet (see Chapter 5: Ordering information on page 14).
30-Sep-2005	3	The following changes were made in this revision. <ul style="list-style-type: none"> – An error in the device description was corrected on page 1. – Chapter 5: Ordering information on page 14 updated with complete list of markings. – Addition of supplementary data in Table 1: Absolute maximum ratings on page 2. – Addition of Table 2: Operating conditions on page 2. – Reorganization of Chapter 4: Package information on page 11. – Minor grammatical and formatting changes throughout.
24-Oct-2008	4	Added performance AC and DC characteristic curves for $V_{CC}=6\text{ V}$, $V_{CC}=10\text{ V}$ and $V_{CC}=30\text{ V}$ in Chapter 3: Electrical characteristics . Modified I_{CC} typ, added parameters over temperature in Table 3 . Deleted old macromodel. Added R_{thjc} , R_{thja} in Table 1 . Corrected V_i and V_{id} AMR values in Table 1 . Added input common mode range V_{icm} in Table 2: Operating conditions . Updated Section 4.1: DIP14 package information and Section 4.2: SO-14 package information .
12-Sep-2012	5	Updated Features (removed “macromodel”). Updated CMR and SVR test conditions in Table 3 . Updated ECOPACK text in Section 4 . Removed TS514IYD, TS514IYDT, TS514AIYD, and TS514AIYDT order code from Table 6 . Minor corrections throughout document.

Please Read Carefully:

Information in this document is provided solely in connection with ST products. STMicroelectronics NV and its subsidiaries ("ST") reserve the right to make changes, corrections, modifications or improvements, to this document, and the products and services described herein at any time, without notice.

All ST products are sold pursuant to ST's terms and conditions of sale.

Purchasers are solely responsible for the choice, selection and use of the ST products and services described herein, and ST assumes no liability whatsoever relating to the choice, selection or use of the ST products and services described herein.

No license, express or implied, by estoppel or otherwise, to any intellectual property rights is granted under this document. If any part of this document refers to any third party products or services it shall not be deemed a license grant by ST for the use of such third party products or services, or any intellectual property contained therein or considered as a warranty covering the use in any manner whatsoever of such third party products or services or any intellectual property contained therein.

UNLESS OTHERWISE SET FORTH IN ST'S TERMS AND CONDITIONS OF SALE ST DISCLAIMS ANY EXPRESS OR IMPLIED WARRANTY WITH RESPECT TO THE USE AND/OR SALE OF ST PRODUCTS INCLUDING WITHOUT LIMITATION IMPLIED WARRANTIES OF MERCHANTABILITY, FITNESS FOR A PARTICULAR PURPOSE (AND THEIR EQUIVALENTS UNDER THE LAWS OF ANY JURISDICTION), OR INFRINGEMENT OF ANY PATENT, COPYRIGHT OR OTHER INTELLECTUAL PROPERTY RIGHT.

UNLESS EXPRESSLY APPROVED IN WRITING BY TWO AUTHORIZED ST REPRESENTATIVES, ST PRODUCTS ARE NOT RECOMMENDED, AUTHORIZED OR WARRANTED FOR USE IN MILITARY, AIR CRAFT, SPACE, LIFE SAVING, OR LIFE SUSTAINING APPLICATIONS, NOR IN PRODUCTS OR SYSTEMS WHERE FAILURE OR MALFUNCTION MAY RESULT IN PERSONAL INJURY, DEATH, OR SEVERE PROPERTY OR ENVIRONMENTAL DAMAGE. ST PRODUCTS WHICH ARE NOT SPECIFIED AS "AUTOMOTIVE GRADE" MAY ONLY BE USED IN AUTOMOTIVE APPLICATIONS AT USER'S OWN RISK.

Resale of ST products with provisions different from the statements and/or technical features set forth in this document shall immediately void any warranty granted by ST for the ST product or service described herein and shall not create or extend in any manner whatsoever, any liability of ST.

ST and the ST logo are trademarks or registered trademarks of ST in various countries.

Information in this document supersedes and replaces all information previously supplied.

The ST logo is a registered trademark of STMicroelectronics. All other names are the property of their respective owners.

© 2012 STMicroelectronics - All rights reserved

STMicroelectronics group of companies

Australia - Belgium - Brazil - Canada - China - Czech Republic - Finland - France - Germany - Hong Kong - India - Israel - Italy - Japan - Malaysia - Malta - Morocco - Philippines - Singapore - Spain - Sweden - Switzerland - United Kingdom - United States of America

www.st.com