



Chipsmall Limited consists of a professional team with an average of over 10 year of expertise in the distribution of electronic components. Based in Hongkong, we have already established firm and mutual-benefit business relationships with customers from,Europe,America and south Asia,supplying obsolete and hard-to-find components to meet their specific needs.

With the principle of "Quality Parts,Customers Priority,Honest Operation,and Considerate Service",our business mainly focus on the distribution of electronic components. Line cards we deal with include Microchip,ALPS,ROHM,Xilinx,Pulse,ON,Everlight and Freescale. Main products comprise IC,Modules,Potentiometer,IC Socket,Relay,Connector.Our parts cover such applications as commercial,industrial, and automotives areas.

We are looking forward to setting up business relationship with you and hope to provide you with the best service and solution. Let us make a better world for our industry!



## Contact us

Tel: +86-755-8981 8866 Fax: +86-755-8427 6832

Email & Skype: info@chipsmall.com Web: www.chipsmall.com

Address: A1208, Overseas Decoration Building, #122 Zhenhua RD., Futian, Shenzhen, China



## 80mA Low Noise LDO Voltage Regulator with Enable Function

### GENERAL DESCRIPTION

TS5213 is an efficient linear voltage regulator with ultra-low noise output, very low dropout voltage (typically 50mV at light loads and 320mV at 80mA), and very low ground current (225µA at 20mA), providing high output current even when the application requires very low dropout voltage. The Chip Enable (EN) includes a CMOS or TTL compatible input allows the output to be turned off to prolong battery life. When shutdown, power consumption drops nearly to zero. TS5213 is included a precision voltage reference, error correction circuit, a current limited output driver, over temperature shutdown and reversed battery protection.

### FEATURES

- Ultra Low Noise Output
- Output Current up to 80mA
- Low Power Consumption
- “Zero” Off-mode Consumption
- Logic Controlled Electronic Enable
- Current Limit & Thermal Shutdown Protection

### APPLICATION

- Cellular Telephones
- Palmtops, Notebook Computers
- Battery Powered Equipment
- SMPS Post Regulator and DC to DC Modules
- High-efficiency Linear Power Supplies
- Portable Application



#### Pin Definition:

1. Input
2. Ground
3. Enable
4. N/C
5. Output

**Notes:** Moisture sensitivity level: level 3. Per J-STD-020

### TYPICAL APPLICATION CIRCUIT

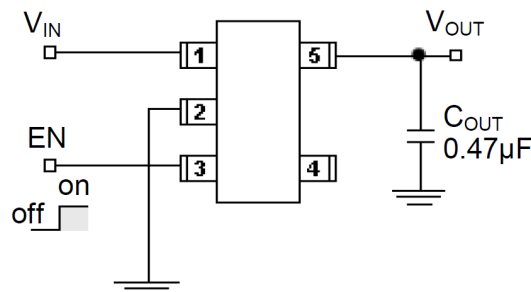

EN may be connected to  $V_{IN}$  pin to regulation ON  
 $C_{IN} > 0.1\mu F$  in basic operating  
 $C_{OUT} > 0.47\mu F$  in low noise operating

**ABSOLUTE MAXIMUM RATINGS** ( $T_A = 25^\circ\text{C}$  unless otherwise noted) (Note 1)

| PARAMETER  | SYMBOL          | LIMIT            | UNIT                      |
|--|-----------------|------------------|---------------------------|
| Input Supply Voltage                               | $V_{IN}$        | -20~ +20         | V                         |
| Enable Input Voltage                               | $V_{CE}$        | -20~ +20         | V                         |
| Power Dissipation (Note 2)                         | $P_D$           | Internal limited |                           |
| Thermal Resistance                                 | $R_{\theta JA}$ | 220              | $^\circ\text{C}/\text{W}$ |
| Operating Junction Temperature Range               | $T_J$           | -40 ~ +125       | $^\circ\text{C}$          |
| Storage Temperature Range                          | $T_{STG}$       | -65 ~ +150       | $^\circ\text{C}$          |
| Lead Soldering Temperature (260 $^\circ\text{C}$ ) |                 | 5                | S                         |

**RECOMMEND OPERATING RATING** (Note 2)

| PARAMETER            | SYMBOL   | LIMIT        | UNIT |
|----------------------|----------|--------------|------|
| Input Supply Voltage | $V_{IN}$ | +2.5 ~ +16   | V    |
| Enable Input Voltage | $V_{CE}$ | 0 ~ $V_{IN}$ | V    |

**ELECTRICAL SPECIFICATIONS**

( $V_{IN} = V_O + 1\text{V}$ ,  $I_O = 100\mu\text{A}$ ,  $C_{OUT} = 1\mu\text{F}$ ,  $V_{ce} \geq 2\text{V}$ ,  $T_A = 25^\circ\text{C}$  unless otherwise noted)

| PARAMETER                        | CONDITIONS   | MIN                    | TYP   | MAX  | UNIT                  |               |
|----------------------------------|--|------------------------|-------|------|-----------------------|---------------|
| Output Voltage                   | $V_{IN} = V_O + 1\text{V}$                           | -3                     | --    | 3    | %                     |               |
|                                  | $-40^\circ\text{C} \leq T_J \leq +125^\circ\text{C}$ | -4                     | --    | 4    |                       |               |
| Output Voltage Temp. Coefficient | (Note 5)   | --                     | 50    | 200  | ppm/ $^\circ\text{C}$ |               |
| Line Regulation                  | $V_O + 1\text{V} \leq V_{IN} \leq 16\text{V}$        | --                     | 0.008 | 0.3  | %                     |               |
| Load Regulation (Note 6)         | $0.1\text{mA} \leq I_O \leq 80\text{mA}$             | --                     | 0.08  | 0.3  | %                     |               |
| Dropout Voltage (Note 7)         | $I_O = 100\mu\text{A}$                               | --                     | 50    | --   | mV                    |               |
|                                  | $I_O = 20\text{mA}$                                  | --                     | 230   | 300  |                       |               |
|                                  | $I_O = 50\text{mA}$                                  | --                     | 280   | 370  |                       |               |
|                                  | $I_O = 80\text{mA}$                                  | --                     | 320   | 420  |                       |               |
| Quiescent Current                | $V_{EN} \leq 0.4\text{V}$ (shutdown)                 | --                     | 0.01  | 10   | $\mu\text{A}$         |               |
| Ground Pin Current (Note 8)      | $V_{EN} \geq 2\text{V}$<br>(active)                  | $I_O = 100\mu\text{A}$ | --    | 80   | --                    | $\mu\text{A}$ |
|                                  |  | $I_O = 20\text{mA}$    | --    | 225  | 750                   |               |
|                                  |  | $I_O = 50\text{mA}$    | --    | 850  | --                    |               |
|                                  |  | $I_O = 80\text{mA}$    | --    | 1800 | 3000                  |               |
| Output Current Limit             | $V_{OUT} = 0\text{V}$                                | --                     | 250   | 500  | mA                    |               |
| Power Supply Rejection Ratio     | At $f = 100\text{Hz}$ , $I_O = 100\mu\text{A}$ ,     | --                     | 65    | --   | dB                    |               |
| Thermal Regulation (Note 9)      |  | --                     | 0.05  | --   | %/W                   |               |

**ELECTRICAL SPECIFICATIONS**

 ( $V_{IN} = V_O + 1V$ ,  $I_O = 100\mu A$ ,  $C_{OUT} = 1\mu F$ ,  $V_{ce} \geq 2V$ ,  $T_A = 25^\circ C$  unless otherwise noted)

**Enable Function**

| PARAMETER                       | CONDITIONS          | MIN | TYP  | MAX | UNIT    |
|---------------------------------|---------------------|-----|------|-----|---------|
| Enable Input Logic-Low Voltage  | Regulation shutdown | --  | --   | 0.6 | V       |
| Enable Input Logic-High Voltage | Regulation enable   | 2.0 | --   | --  | V       |
| Enable Input Current            | $V_{IL} \leq 0.6V$  | --  | 0.01 | 1   | $\mu A$ |
|                                 | $V_{IH} \geq 2.0V$  | --  | 15   | 50  | V       |

**Note:**

- Exceeding the absolute maximum rating may damage the device.
- The maximum allowable power dissipation at any  $T_A$  is  $P_{D(MAX)} = [T_{J(MAX)} - T_A] + R_{\theta JA}$ . Exceeding the maximum allowable power dissipation will result in excessive die temperature, and the regulator will go into thermal shutdown.
- Devices are ESD sensitive. Handling precautions recommended.
- The device is not guaranteed to function outside its operating rating.
- Output voltage temperature coefficient is defined as the worst case voltage change divided by the total temperature range.
- Regulation is measured at constant junction temperature using low duty cycle pulse testing. Parts are tested for load regulation in the load range from 1mA to 80mA. Changes in output voltage due to heating effects are covered by the thermal regulation specification.
- Dropout voltage is defined as the input to output differential at which the output voltage drops 2% below its nominal value measured at 1V differential.
- Ground pin current is the regulator quiescent current plus pass transistor base current. The total current drawn from the supply is the sum of the load current plus the ground pin current.
- Thermal regulation is defined as the change in output voltage at a time "t" after a change in power dissipation is applied, excluding load or line regulation effects. Specifications are for a 80mA load pulse at  $V_{IH} = 16V$  for  $t = 10ms$ .

## ORDERING INFORMATION

| OUTPUT VOLTAGE | PART NO.        | PACKAGE | PACKING            |
|----------------|-----------------|---------|--------------------|
| 3.3V           | TS5213CX533 RFG | SOT-25  | 3,000pcs / 7" Reel |
| 5V             | TS5213CX550 RFG | SOT-25  | 3,000pcs / 7" Reel |

**Note:**

1. Compliant to RoHS Directive 2011/65/EU and in accordance to WEEE 2002/96/EC.
2. Halogen-free according to IEC 61249-2-21 definition.

## BLOCK DIAGRAMS

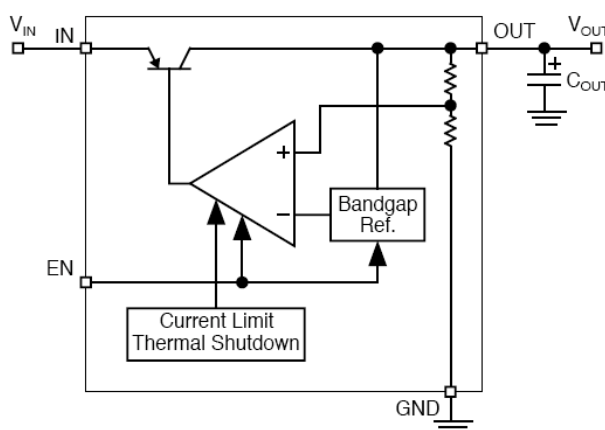

## APPLICATION INFORMATION

### Enable Input

TS5213 series feature an active-high (>2V) enable (EN) input that allows ON/OFF control of the regulator. Current drain reduces to “zero” when the device is shutdown, with only micro-amperes of leakage current. The EN is compatible with CMOS logic interfacing. EN may be directly tied to  $V_{IH}$  and pulled up to the maximum supply voltage.

### Input Capacitor Requirement

An input capacitor of 0.17 $\mu$ F or greater is recommended when the device is more than 10” away from the bulk AC supply capacitance or when the supply is a battery.

### Output Capacitor Requirement

The TS5213 series requires an output capacitor to maintain stability and improve transient response is necessary. The TS5213 is ultra-stable, requiring only 0.47 $\mu$ F of output capacitance for stability. It is stable with all type of capacitors, including the tiny, low-ESR ceramic chip capacitors. The output capacitor value may be increased without limit.

### No Load Stability

The TS5213 series will remain stable and in regulation with no load, unlike many other voltage regulators. This is especially important in CMOS RAM keep alive applications.

## APPLICATION INFORMATION (CONTINUE)

### Thermal Characteristics

TS5213 series is designed to provide 80mA of continuous current in a very small package. Maximum power dissipation can be calculated based on the output current and the voltage drop across the part. To determine the maximum power dissipation of the package, use the junction-ambient thermal resistance of the device and the following basic equation:

$$P_{D(MAX)} = [ T_{J(MAX)} - T_A ] / \Theta_{JA}$$

$T_{J(MAX)}$  is the maximum junction temperature of the die(125°C), and  $T_a$  is the ambient operating temperature.  $\Theta_{JA}$  is layout dependent, the actual power dissipation of the regulator circuit can be determined using the equation:

$$P_D = (V_{IN} - V_{OUT}) * I_{OUT} + V_{IN} * I_{GND}$$

Substituting  $P_{D(MAX)}$  for  $P_D$  and solving for the operating conditions that are critical to the application will give the maximum operating conditions for the regulator circuit. For example, when operating the TS5213CX550 at room temperature with a minimum footprint layout, the maximum input voltage for a set output current can be determined as follows:

$$P_{D(MAX)} = (125^{\circ}\text{C} - 25^{\circ}\text{C}) / 220^{\circ}\text{C/W}$$

$$P_{D(MAX)} = 455\text{mW}$$

The junction to ambient thermal resistance for the minimum footprint is 220°C/W, the maximum power dissipation must not be exceeded for proper operation. Using the output voltage of 5.0V and an output current of 80mA, the maximum input voltage can be determined. Form the electrical characteristics table, the maximum ground current for 80mA output current is 1mA.

$$445\text{mW} = (V_{IN} - 5.0\text{V}) * 80\text{mA} + V_{IN} * 1.8\text{mA}$$

$$445\text{mW} = V_{IN} * 80\text{mA} - 5.0 * 80\text{mA} + V_{IN} * 1.8\text{mA}$$

$$445\text{mW} = V_{IN} * 80\text{mA} - 400\text{mW} + V_{IN} * 1.8\text{mA}$$

$$845\text{mW} = V_{IN} * 81.8\text{mA}$$

$$V_{IN} (\text{max}) = 10.33\text{V}$$

Therefore, a 5.0V application at 80mA of output current can accept a maximum input voltage of 10.33V in a SOT-25 package.

**CHARACTERISTICS CURVES**

( $T_C = 25^\circ\text{C}$  unless otherwise noted)

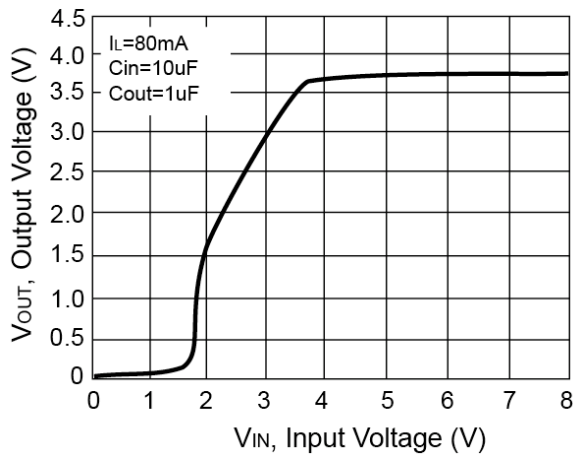

**Figure 1. Output Voltage vs. Input Voltage**

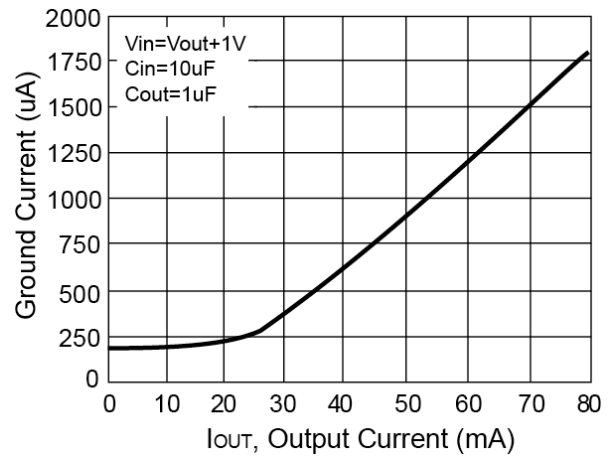

**Figure 2. Ground Current vs. Output Current**

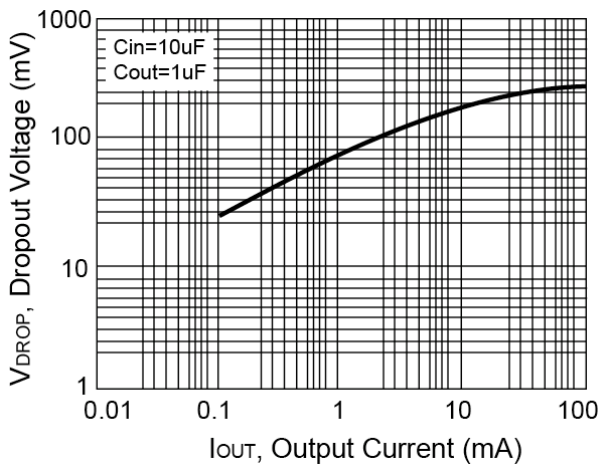

**Figure 3. Dropout Voltage vs. Output Current**

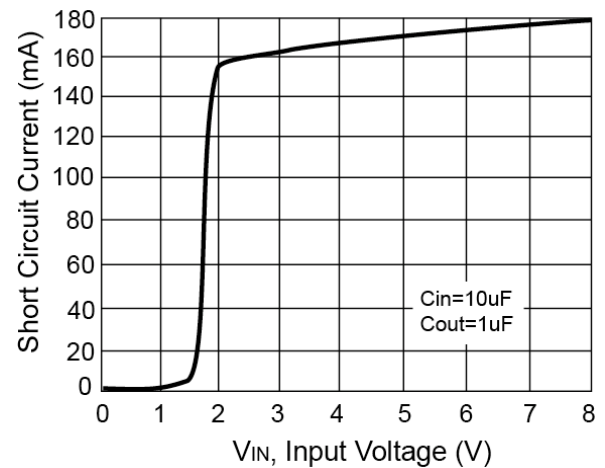

**Figure 4. Short Circuit Current vs. Input Voltage**

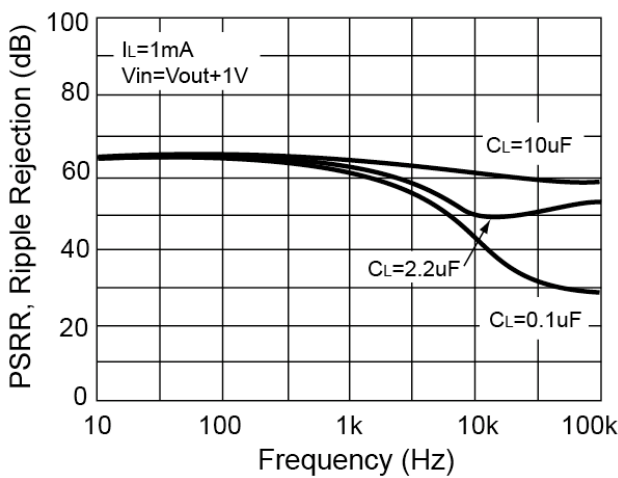

**Figure 5. Ripple Rejection vs. Frequency**

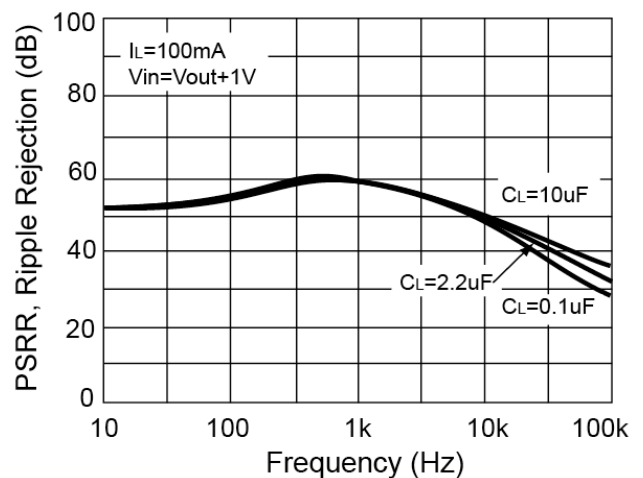

**Figure 6. Ripple Rejection vs. Frequency**

**PACKAGE OUTLINE DIMENSIONS** (Unit: Millimeters)

**SOT-25**

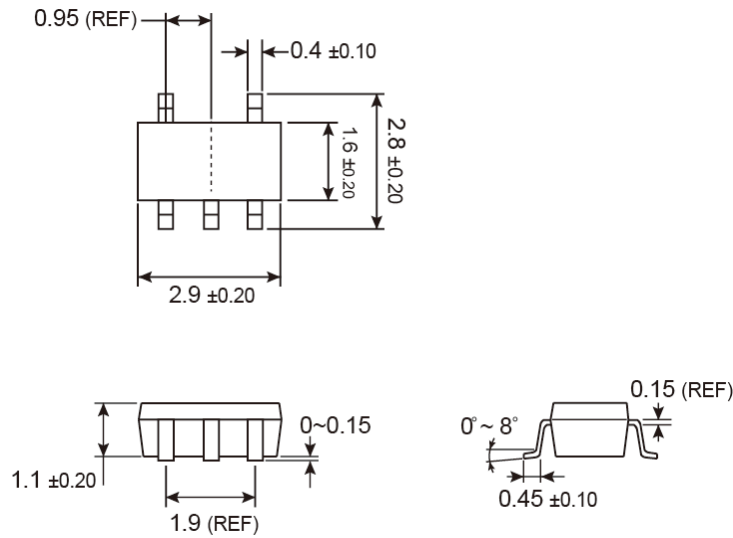

**SUGGESTED PAD LAYOUT** (Unit: Millimeters)

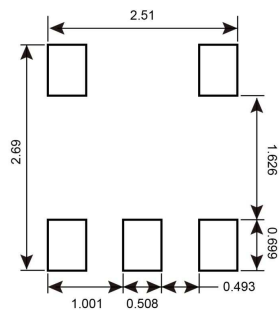

**MARKING DIAGRAM**

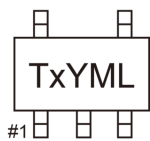

- T** = Device Code
- X** = Voltage Code (**5** = 5.0V, **S** = 3.3V)
- Y** = Year Code
- M** = Month Code for Halogen Free Product
  - O** =Jan    **P** =Feb    **Q** =Mar    **R** =Apr
  - S** =May    **T** =Jun    **U** =Jul    **V** =Aug
  - W** =Sep    **X** =Oct    **Y** =Nov    **Z** =Dec
- L** = Lot Code (1~9, A~Z)



## Notice

Specifications of the products displayed herein are subject to change without notice. TSC or anyone on its behalf, assumes no responsibility or liability for any errors or inaccuracies.

Information contained herein is intended to provide a product description only. No license, express or implied, to any intellectual property rights is granted by this document. Except as provided in TSC's terms and conditions of sale for such products, TSC assumes no liability whatsoever, and disclaims any express or implied warranty, relating to sale and/or use of TSC products including liability or warranties relating to fitness for a particular purpose, merchantability, or infringement of any patent, copyright, or other intellectual property right.

The products shown herein are not designed for use in medical, life-saving, or life-sustaining applications. Customers using or selling these products for use in such applications do so at their own risk and agree to fully indemnify TSC for any damages resulting from such improper use or sale.