



Chipsmall Limited consists of a professional team with an average of over 10 year of expertise in the distribution of electronic components. Based in Hongkong, we have already established firm and mutual-benefit business relationships with customers from,Europe,America and south Asia,supplying obsolete and hard-to-find components to meet their specific needs.

With the principle of “Quality Parts,Customers Priority,Honest Operation,and Considerate Service”,our business mainly focus on the distribution of electronic components. Line cards we deal with include Microchip,ALPS,ROHM,Xilinx,Pulse,ON,Everlight and Freescale. Main products comprise IC,Modules,Potentiometer,IC Socket,Relay,Connector.Our parts cover such applications as commercial,industrial, and automotives areas.

We are looking forward to setting up business relationship with you and hope to provide you with the best service and solution. Let us make a better world for our industry!



Contact us

Tel: +86-755-8981 8866 Fax: +86-755-8427 6832

Email & Skype: info@chipsmall.com Web: www.chipsmall.com

Address: A1208, Overseas Decoration Building, #122 Zhenhua RD., Futian, Shenzhen, China



320MHz Single Supply Video Buffer with Low In/Out Rail

- **Bandwidth: 320MHz**
- **Single supply operation down to 3V**
- **Low input & output rail**
- **Very low harmonic distortion**
- **Slew rate: 780V/ μ s**
- **Voltage input noise: 7nV/ \sqrt Hz**
- **Specified for 150 Ω and 100 Ω loads**
- **Internal gain of 6dB**
- **Compatible with the PCB layout of a single op-amp**
- **Tested on 5V power supply**
- **Data min. and max. are tested during production**

Description

The TSH340 is a single supply video buffer featuring an internal gain of 6dB and a large bandwidth of 320MHz for only 9.8mA of quiescent current.

An **advantage** of this circuit is its input and output negative rail feature, which is very close to GND in single supply. This rail is tested and guaranteed during production at 60mV maximum from GND on a 150 Ω load. This allows a good output swing which fits perfectly when driving a video signal on a 75 Ω video line. *Chapter 5* of this datasheet gives technical support when using the TSH340 as a driver for video DAC output on a video line. In particular, this chapter focuses on applying a video signal DC shift to avoid any clamping of the synchronization tip.

The TSH340 is available in tiny SOT23-5 and SO8 plastic packages.

Order Codes

| Part Number | Temperature Range | Package | Packaging | Marking |
|-------------|-------------------|---------|-------------|---------|
| TSH340ILT | -40°C to +85°C | SOT23-5 | Tape & Reel | K306 |
| TSH340ID | | | Tube | TSH340I |
| TSH340IDT | | SO-8 | Tape & Reel | TSH340I |

Pin Connections (top view)

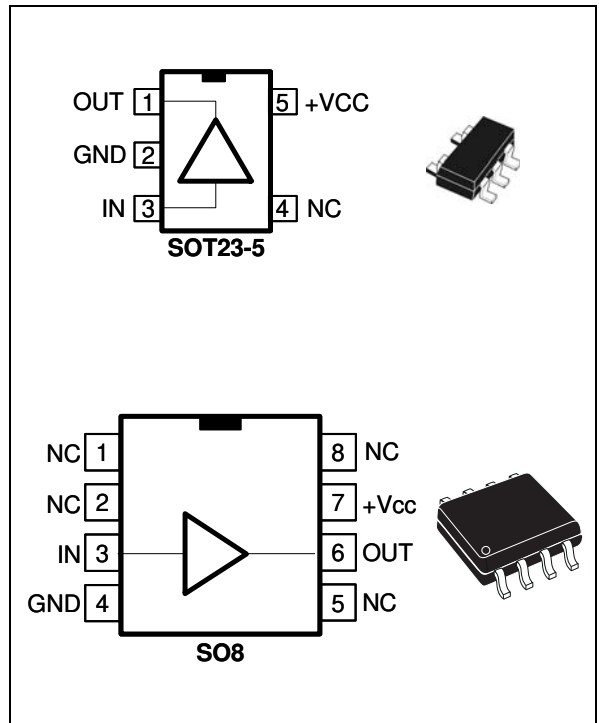

Applications

- **High-end video systems**
- **High Definition TV (HDTV)**
- **Broadcast and graphic video**
- **Multimedia products**

1 Absolute Maximum Ratings

Table 1. Key parameters and their absolute maximum ratings

| Symbol | Parameter | Value | Unit |
|------------|---|-------------|------|
| V_{CC} | Supply voltage ¹ | 6 | V |
| V_{in} | Input Voltage Range ² | -0.2 to +3 | V |
| T_{oper} | Operating Free Air Temperature Range | -40 to +85 | °C |
| T_{std} | Storage Temperature | -65 to +150 | °C |
| T_j | Maximum Junction Temperature | 150 | °C |
| R_{thjc} | Thermal Resistance Junction to Case SOT23-5 SO8 | 80 | °C/W |
| | | 75 | |
| R_{thja} | Thermal Resistance Junction to Ambient Area SOT23-5 SO8 | 250 | °C/W |
| | | 175 | |
| $P_{max.}$ | Maximum Power Dissipation (@ $T_a=25^{\circ}C$) for $T_j=150^{\circ}C$ SOT23-5 SO8 | 500 | mW |
| | | 715 | |
| ESD | CDM: Charged Device Model HBM: Human Body Model MM: Machine Model | 2 | kV |
| | | 1.5 | kV |
| | | 200 | V |

1) All voltage values, except differential voltage, are with respect to network terminal.

2) The magnitude of input and output voltage must never exceed $V_{CC} + 0.3V$.

Table 2. Operating conditions

| Symbol | Parameter | Value | Unit |
|-----------|---------------------------|-----------------------|------|
| V_{CC} | Power Supply Voltage | 3 to 5.5 ¹ | V |
| V_{icm} | Common Mode Input Voltage | -0.4 to 3 | V |

1) Tested in full production at 0V/5V single power supply

2 Electrical Characteristics

Table 3. $V_{CC} = +5V$, $T_{amb} = 25^{\circ}C$ (unless otherwise specified)

| Symbol | Parameter | Test Condition | Min. | Typ. | Max. | Unit |
|---|--|--|------|------|------|-----------------|
| DC Performance | | | | | | |
| V_{OS} | Output Offset Voltage ¹ | no Load, T_{amb} | -30 | -5 | +30 | mV |
| | | $-40^{\circ}C < T_{amb} < +85^{\circ}C$ | | -6.8 | | |
| I_{ib} | Input Bias Current | T_{amb} , $V_{icm}=0.6V$ | | 6 | 16 | μA |
| | | $-40^{\circ}C < T_{amb} < +85^{\circ}C$ | | 7.2 | | |
| PSR | Power Supply Rejection Ratio $20 \log (\Delta V_{cc}/\Delta V_{out})$ | $\Delta V_{cc}=200mVp-p$, $F=1MHz$ | | -90 | | dB |
| ICC | Total Supply Current | no Load, $V_{in}=100mV$ | | 9.8 | 12.8 | mA |
| G | DC Voltage Gain | $R_L = 150\Omega$ | 1.95 | 2 | 2.05 | V/V |
| Rin | Input Resistance | T_{amb} | | 8 | | M Ω |
| Cin | Input Capacitance | T_{amb} | | 3.2 | | pF |
| Dynamic Performance and Output Characteristics | | | | | | |
| Bw | -3dB Bandwidth | Small Signal $V_{out}=20mVp$ $V_{icm}=0.6V$, $R_L = 150\Omega$ | 190 | 320 | | MHz |
| | Gain Flatness @ 0.1dB | Small Signal $V_{out}=20mVp$ $V_{icm}=0.6V$, $R_L = 150\Omega$ | | 63 | | |
| FPBW | Full Power Bandwidth | $V_{icm}=0.6V$, $V_{OUT} = 2Vp-p$, $R_L = 150\Omega$ | 130 | 200 | | MHz |
| SR | Slew Rate | $V_{icm}=0.6V$, $V_{OUT} = 2Vp-p$, $R_L = 150\Omega$ | | 780 | | V/ μs |
| V_{OH} | High Level Output Voltage | $R_L = 150\Omega$ | 3.7 | 3.9 | | V |
| V_{OL} | Low Level Output Voltage | $R_L = 150\Omega$ | | 40 | 60 | mV |
| I_{OUT} | Output Short Circuit Current (Isource) | T_{amb} | | 100 | | mA |
| | | $-40^{\circ}C < T_{amb} < +85^{\circ}C$ | | 90 | | |
| | Output Current | $V_{out}=2Vp$, T_{amb} | 45 | 87 | | mA |
| Noise and Distortion | | | | | | |
| eN | Equivalent Input Noise Voltage | $F = 100kHz$ | | 7 | | nV/ \sqrt{Hz} |
| iN | Equivalent Input Noise Current | $F = 100kHz$ | | 1.5 | | pA/ \sqrt{Hz} |
| HD2 | 2nd Harmonic Distortion | $V_{OUT} = 2Vp-p$, $R_L = 150\Omega$ $F = 10MHz$, | | -85 | | dBc |
| HD3 | 3rd Harmonic Distortion | $V_{OUT} = 1Vp-p$, $R_L = 150\Omega$ $F = 10MHz$, | | -75 | | dBc |

1) Output Offset Voltage is determined from the following expression: $V_{OUT} = G \cdot V_{IN} + V_{OS}$

Figure 1. Frequency response

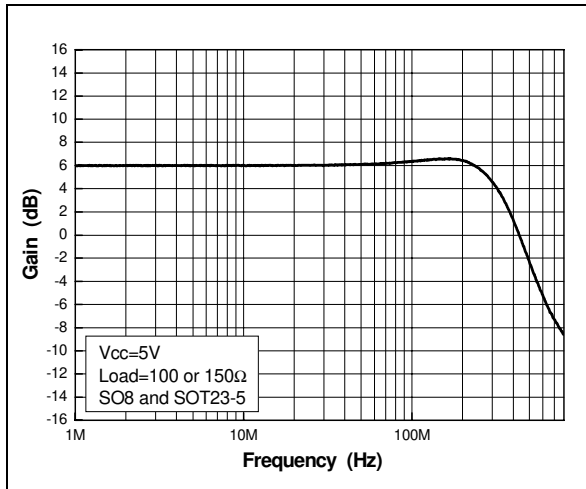

Figure 2. Gain flatness - SOT23-5

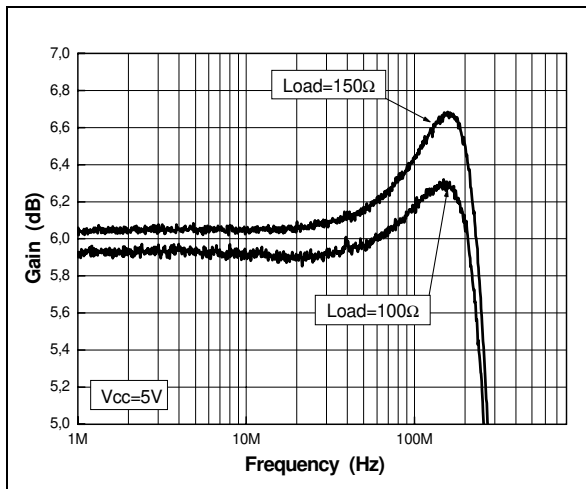

Figure 3. Total input noise vs. frequency

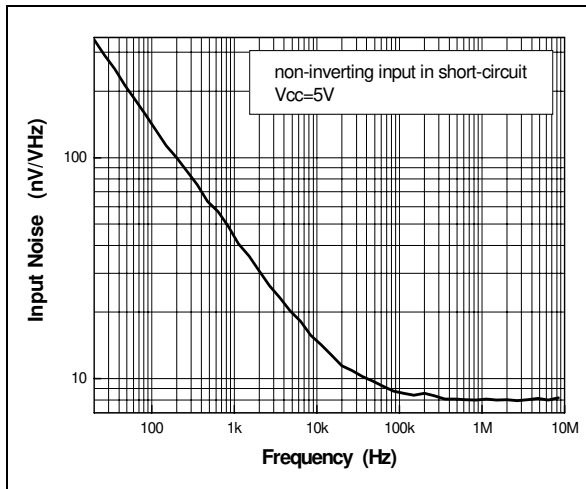

Figure 4. Frequency response on capa-load

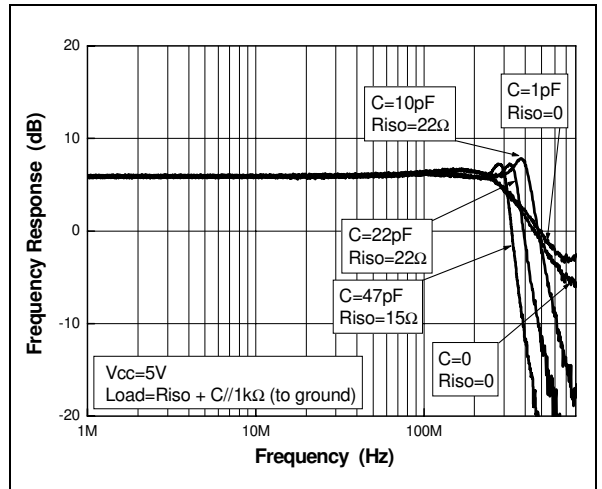

Figure 5. Gain flatness - SO8

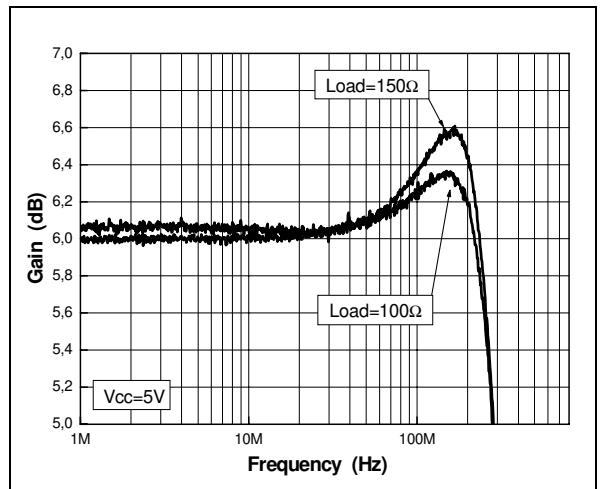

Figure 6. Positive and negative slew rate

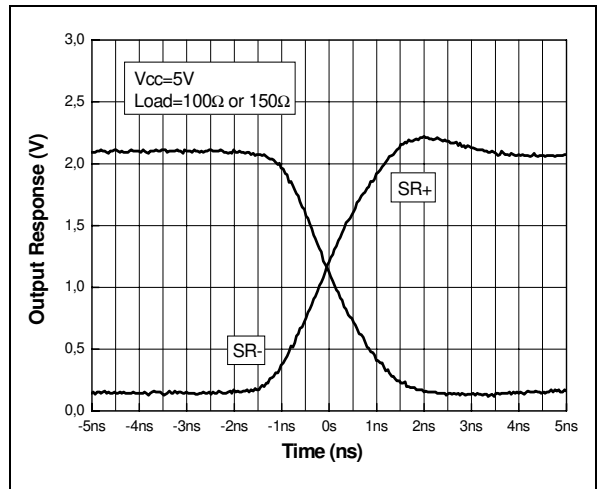

Figure 7. Distortion on 100Ω load

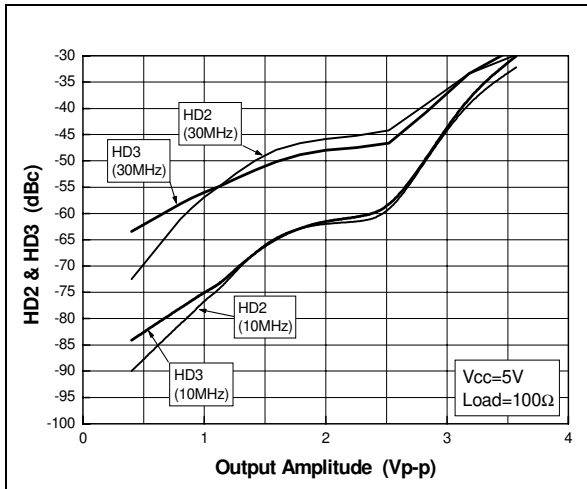

Figure 10. Distortion on 150Ω load

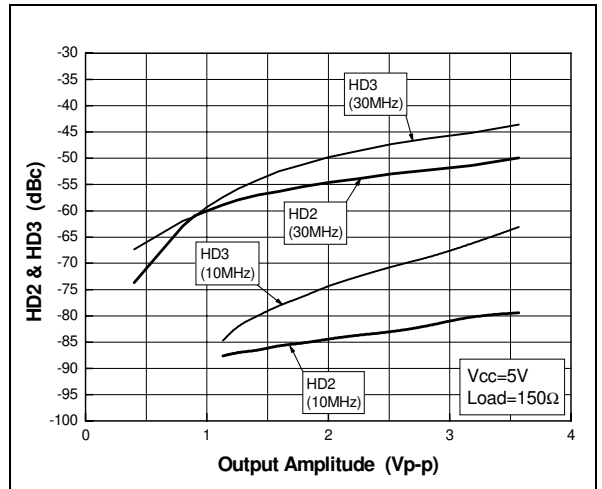

Figure 8. Output lower rail vs. frequency

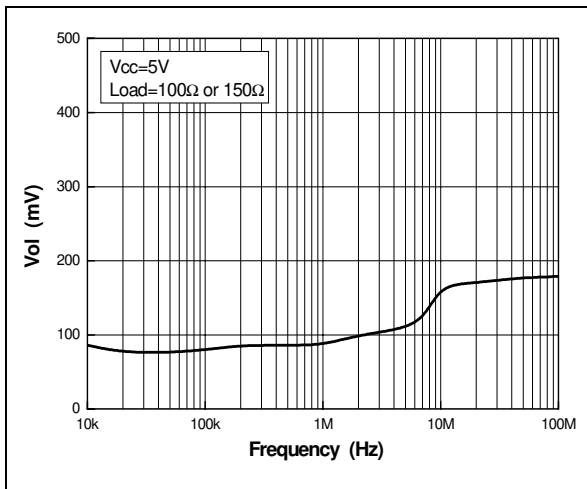

Figure 11. Output voltage swing vs. Vcc

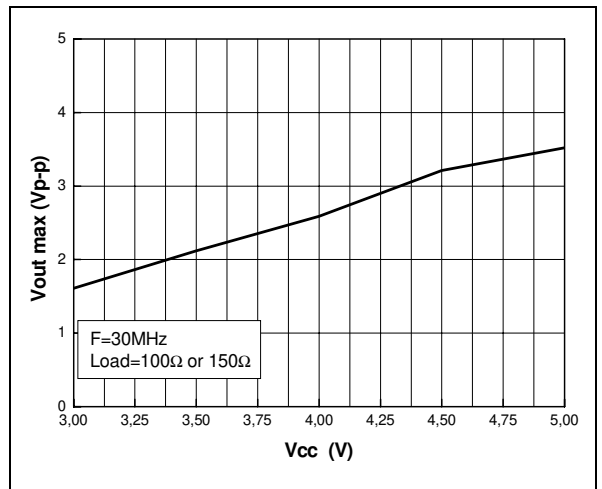

Figure 9. Output voltage swing vs. frequency

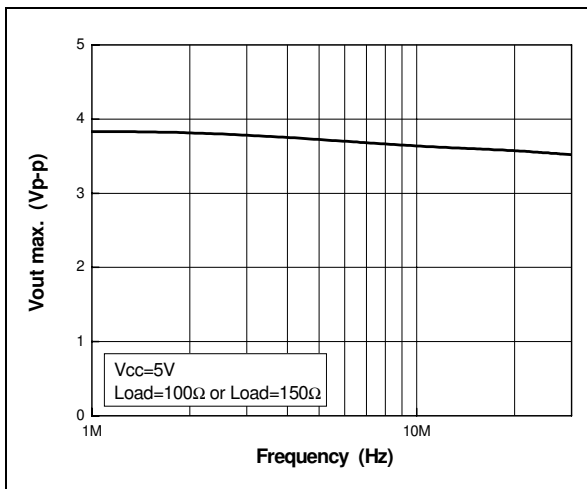

Figure 12. Quiescent current vs. vcc

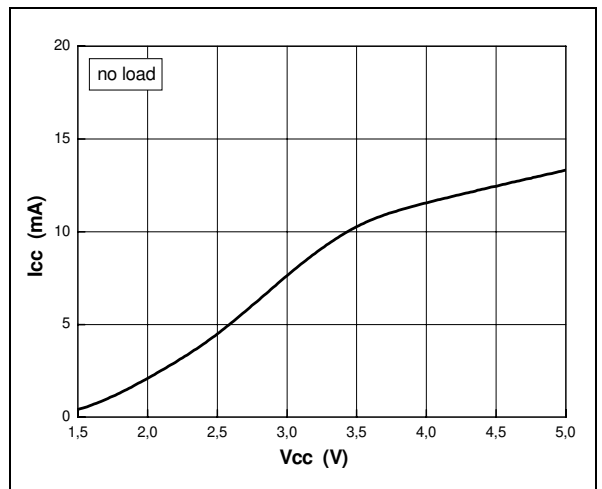

Figure 13. Isource

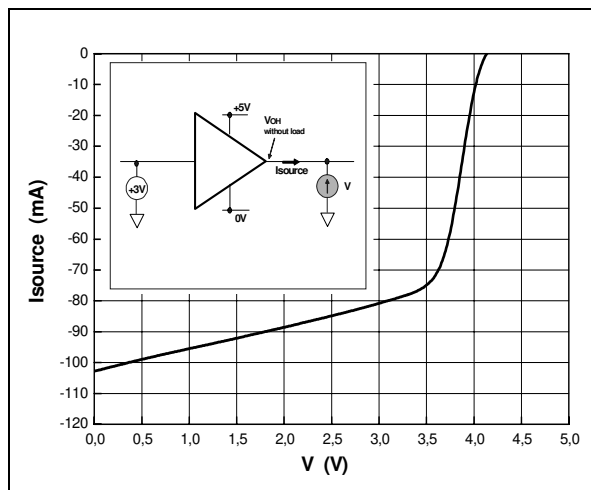

Figure 16. Reverse isolation vs. frequency

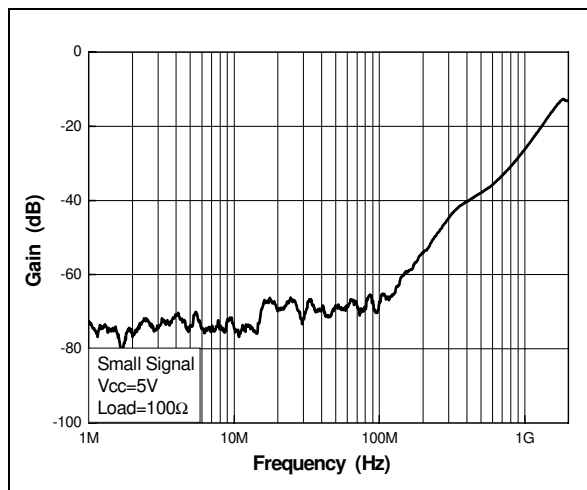

Figure 14. Bandwidth vs. temperature

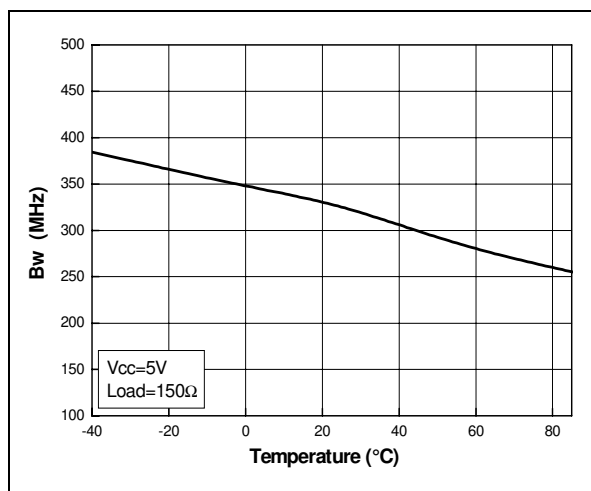

Figure 17. Voltage gain vs. temperature

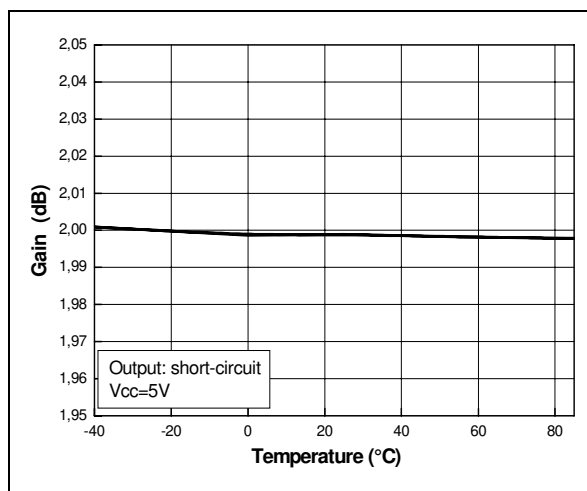

Figure 15. Output offset vs. temperature

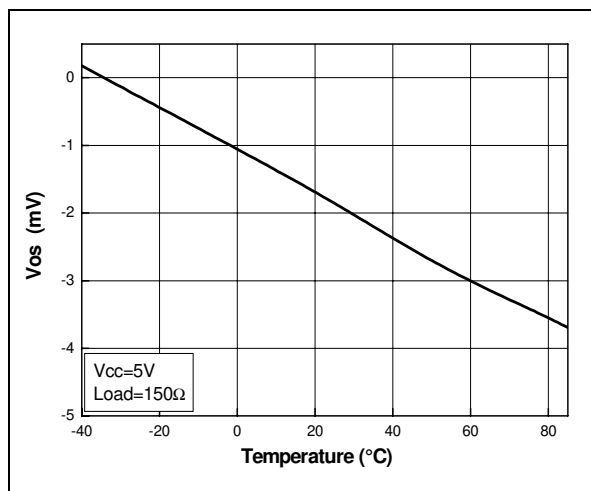

Figure 18. IBIAS vs. temperature

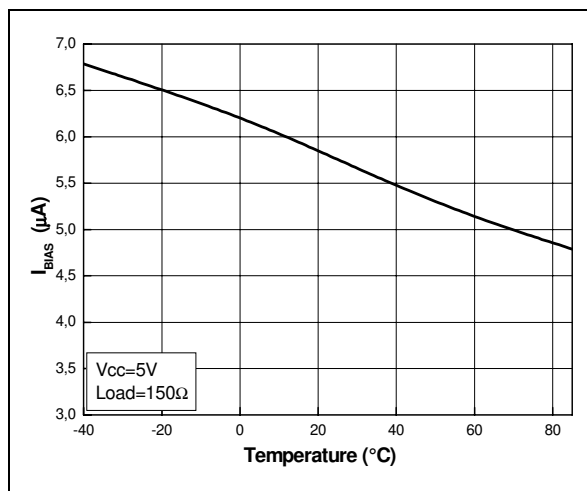

Figure 19. Supply current vs. temperature

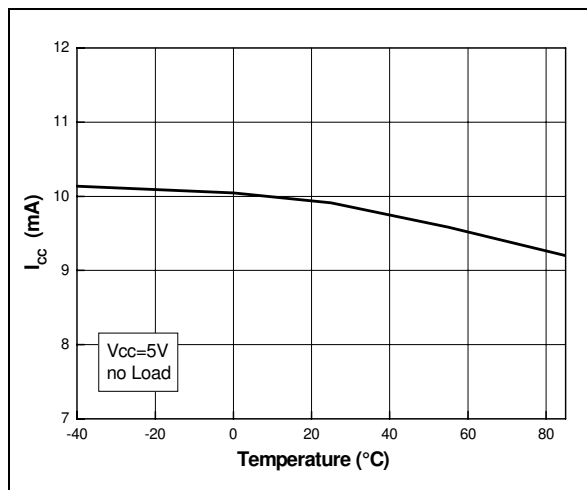

Figure 20. Output lower rail vs. temperature

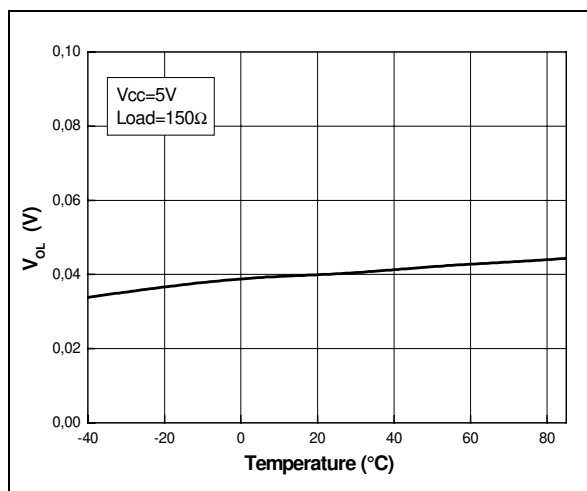
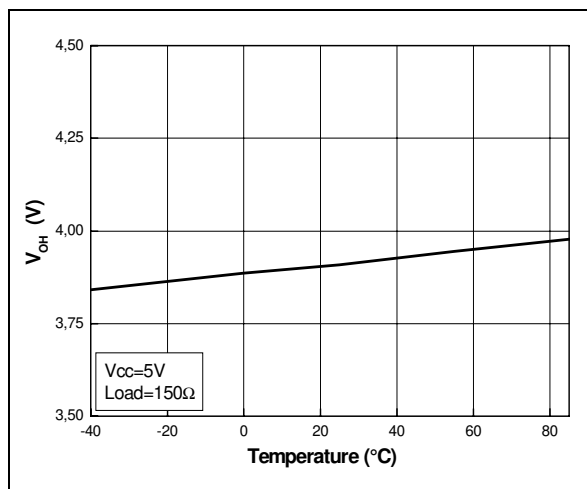

Figure 21. Output higher rail vs. temperature



3 Evaluation Boards

An evaluation board kit optimized for high-speed operational amplifiers is available (order code: KITHSEVAL/STDL). The kit includes the following evaluation boards, as well as a CD-ROM containing datasheets, articles, application notes and a user manual:

- SOT23_SINGLE_HF BOARD: Board for the evaluation of a single high-speed op-amp in SOT23-5 package.
- SO8_SINGLE_HF: Board for the evaluation of a single high-speed op-amp in SO8 package.
- SO8_DUAL_HF: Board for the evaluation of a dual high-speed op-amp in SO8 package.
- SO8_S_MULTI: Board for the evaluation of a single high-speed op-amp in SO8 package in inverting and non-inverting configuration, dual and single supply.
- SO14_TRIPLE: Board for the evaluation of a triple high-speed op-amp in SO14 package with video application considerations.

Board material:

- 2 layers
- FR4 ($\epsilon_r=4.6$)
- epoxy 1.6mm
- copper thickness: 35 μ m

Figure 22: Evaluation kit for high speed op-amps



4 Power Supply Considerations

Correct power supply bypassing is very important for optimizing performance in high-frequency ranges. Bypass capacitors should be placed as close as possible to the IC pins to improve high-frequency bypassing. A capacitor greater than $10\mu\text{F}$ is necessary to minimize the distortion. For better quality bypassing, a capacitor of 10nF is added using the same implementation conditions. Bypass capacitors must be incorporated for both the negative and the positive supply. On the SO8_SINGLE_HF board, these capacitors are C8 and C6.

Figure 23: Circuit for power supply bypassing

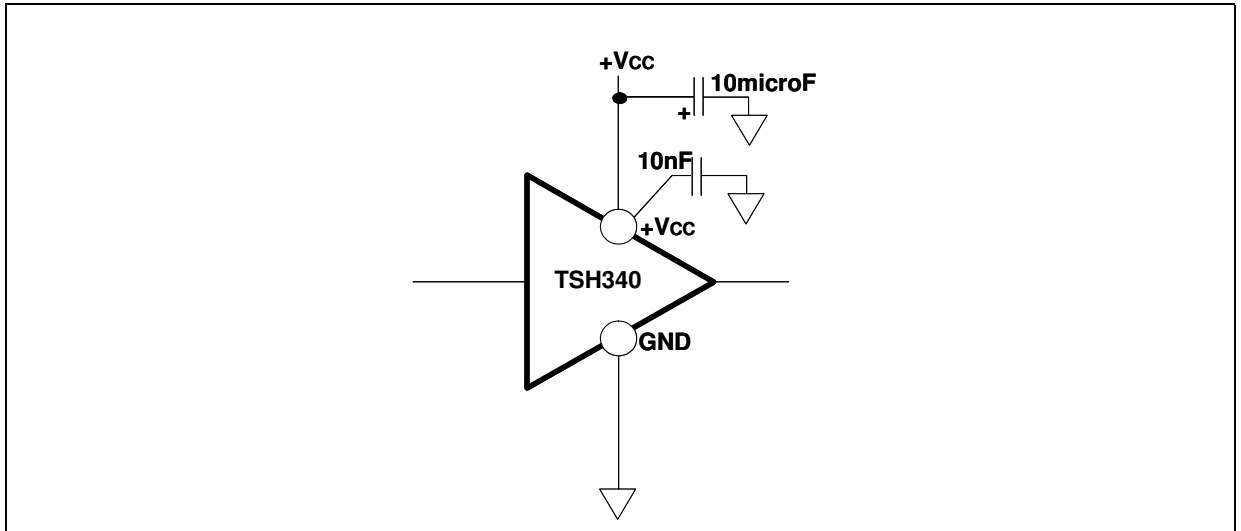

5 Using the TSH340 to Drive Video Signals

Figure 24. Implementation of the video driver on output video DACs

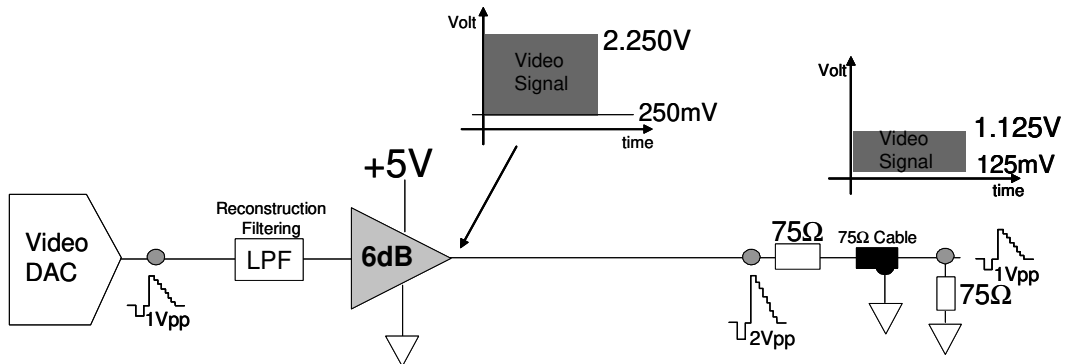

$$V_{OL}(100\text{MHz}) = 180\text{mV} \text{ (Figure 8)}$$

To drive the video signal properly, the output of the driver must be at least equal to 250mV (assuming V_{OS} and V_{OL} variations).

- **1st solution:**

Set the video DAC 0-IRE output level to 125mV.

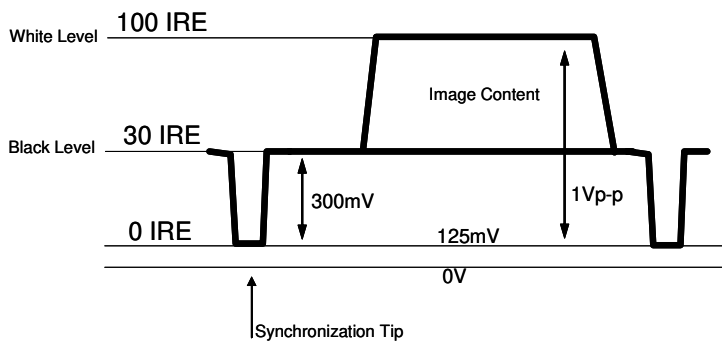

- **2nd solution:**

Implementation of a DC component in the input of the driver.

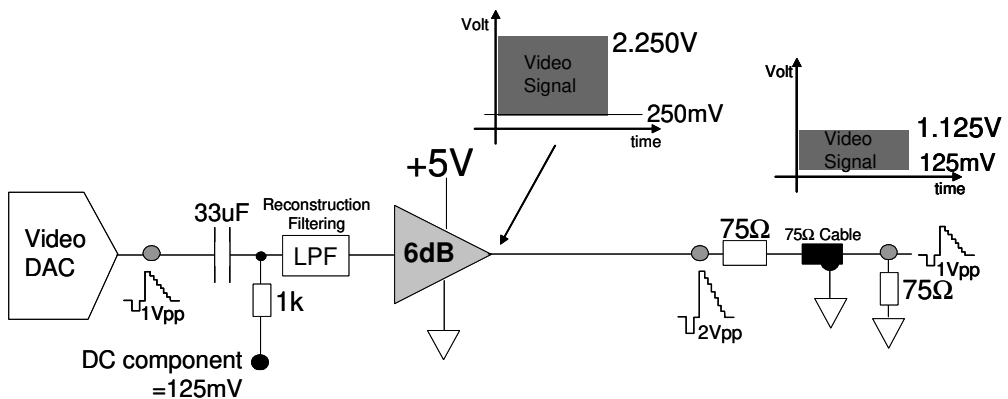

6 Package Mechanical Data

6.1 SO-8 package

SO-8 MECHANICAL DATA

| DIM. | mm. | | | inch | | |
|------|-----------|------|------|-------|-------|-------|
| | MIN. | TYP. | MAX. | MIN. | TYP. | MAX. |
| A | 1.35 | | 1.75 | 0.053 | | 0.069 |
| A1 | 0.10 | | 0.25 | 0.04 | | 0.010 |
| A2 | 1.10 | | 1.65 | 0.043 | | 0.065 |
| B | 0.33 | | 0.51 | 0.013 | | 0.020 |
| C | 0.19 | | 0.25 | 0.007 | | 0.010 |
| D | 4.80 | | 5.00 | 0.189 | | 0.197 |
| E | 3.80 | | 4.00 | 0.150 | | 0.157 |
| e | | 1.27 | | | 0.050 | |
| H | 5.80 | | 6.20 | 0.228 | | 0.244 |
| h | 0.25 | | 0.50 | 0.010 | | 0.020 |
| L | 0.40 | | 1.27 | 0.016 | | 0.050 |
| k | 8° (max.) | | | | | |
| ddd | | | 0.1 | | | 0.04 |

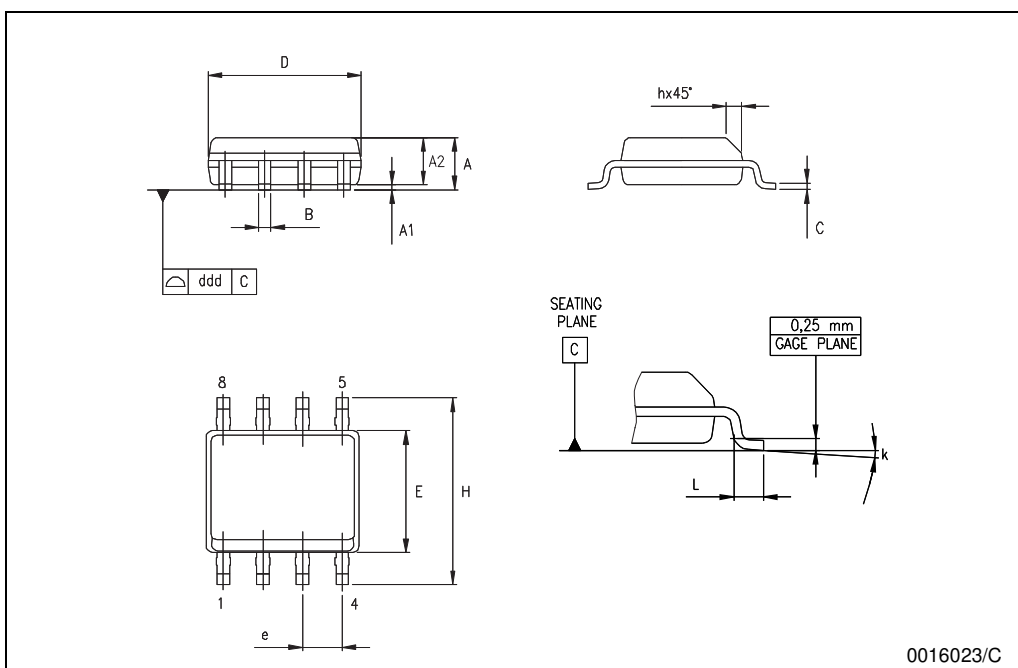

6.2 SOT23-5L (5-pin) package

SOT23-5L MECHANICAL DATA

| DIM. | mm. | | | mils | | |
|------|------|------|------|-------|------|-------|
| | MIN. | TYP. | MAX. | MIN. | TYP. | MAX. |
| A | 0.90 | | 1.45 | 35.4 | | 57.1 |
| A1 | 0.00 | | 0.15 | 0.0 | | 5.9 |
| A2 | 0.90 | | 1.30 | 35.4 | | 51.2 |
| b | 0.35 | | 0.50 | 13.7 | | 19.7 |
| C | 0.09 | | 0.20 | 3.5 | | 7.8 |
| D | 2.80 | | 3.00 | 110.2 | | 118.1 |
| E | 2.60 | | 3.00 | 102.3 | | 118.1 |
| E1 | 1.50 | | 1.75 | 59.0 | | 68.8 |
| e | | 0.95 | | | 37.4 | |
| e1 | | 1.9 | | | 74.8 | |
| L | 0.35 | | 0.55 | 13.7 | | 21.6 |

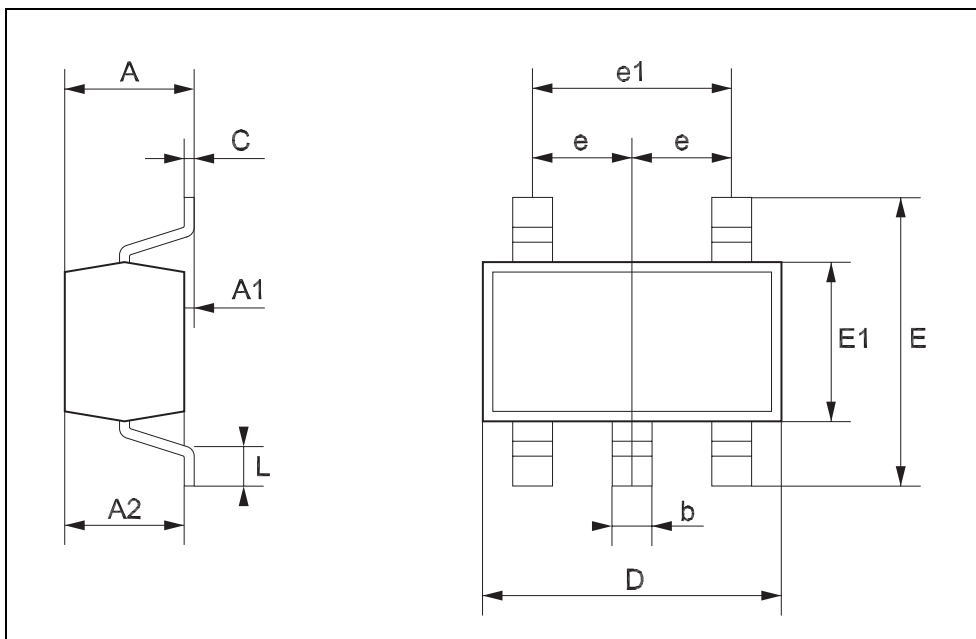

7 Revision History

| Date | Revision | Description of Changes |
|--------------|----------|---|
| 01 Jan. 2005 | 1 | First release corresponding to Preliminary Data version of datasheet. |
| 23 Mar. 2005 | 2 | Datasheet of mature, full-specification product. |

Information furnished is believed to be accurate and reliable. However, STMicroelectronics assumes no responsibility for the consequences of use of such information nor for any infringement of patents or other rights of third parties which may result from its use. No license is granted by implication or otherwise under any patent or patent rights of STMicroelectronics. Specifications mentioned in this publication are subject to change without notice. This publication supersedes and replaces all information previously supplied. STMicroelectronics products are not authorized for use as critical components in life support devices or systems without express written approval of STMicroelectronics.

The ST logo is a registered trademark of STMicroelectronics
All other names are the property of their respective owners

© 2005 STMicroelectronics - All rights reserved

STMicroelectronics group of companies

Australia - Belgium - Brazil - Canada - China - Czech Republic - Finland - France - Germany - Hong Kong - India - Israel - Italy - Japan - Malaysia - Malta - Morocco - Singapore - Spain - Sweden - Switzerland - United Kingdom - United States of America

www.st.com