



Chipsmall Limited consists of a professional team with an average of over 10 year of expertise in the distribution of electronic components. Based in Hongkong, we have already established firm and mutual-benefit business relationships with customers from,Europe,America and south Asia,supplying obsolete and hard-to-find components to meet their specific needs.

With the principle of “Quality Parts,Customers Priority,Honest Operation,and Considerate Service”,our business mainly focus on the distribution of electronic components. Line cards we deal with include Microchip,ALPS,ROHM,Xilinx,Pulse,ON,Everlight and Freescale. Main products comprise IC,Modules,Potentiometer,IC Socket,Relay,Connector.Our parts cover such applications as commercial,industrial, and automotives areas.

We are looking forward to setting up business relationship with you and hope to provide you with the best service and solution. Let us make a better world for our industry!



Contact us

Tel: +86-755-8981 8866 Fax: +86-755-8427 6832

Email & Skype: info@chipsmall.com Web: www.chipsmall.com

Address: A1208, Overseas Decoration Building, #122 Zhenhua RD., Futian, Shenzhen, China



IR Receiver Modules for Remote Control Systems

Description

The TSOP22..MQ1 - series are miniaturized receivers for infrared remote control systems. PIN diode and preamplifier are assembled on lead frame, the epoxy package is designed as IR filter.

The demodulated output signal can directly be decoded by a microprocessor. TSOP22..MQ1 is the standard IR remote control receiver series, supporting all major transmission codes.

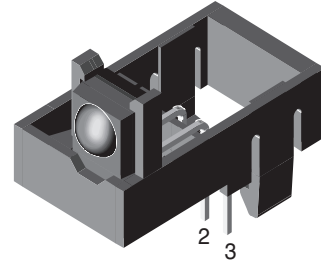

16870

Features

- Photo detector and preamplifier in one package
- Internal filter for PCM frequency
- Improved shielding against electrical field disturbance
- TTL and CMOS compatibility
- Output active low
- Low power consumption



Special Features

- Improved immunity against ambient light
- Suitable burst length ≥ 10 cycles/burst

Parts Table

Part	Carrier Frequency
TSOP2230MQ1	30 kHz
TSOP2233MQ1	33 kHz
TSOP2236MQ1	36 kHz
TSOP2237MQ1	36.7 kHz
TSOP2238MQ1	38 kHz
TSOP2240MQ1	40 kHz
TSOP2256MQ1	56 kHz

Block Diagram

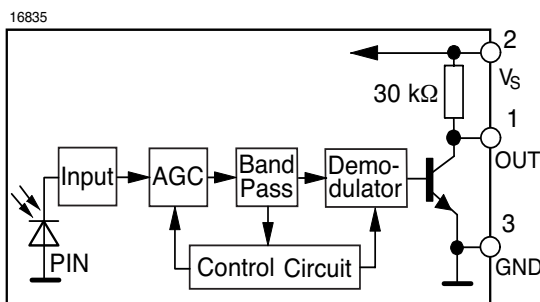

Application Circuit

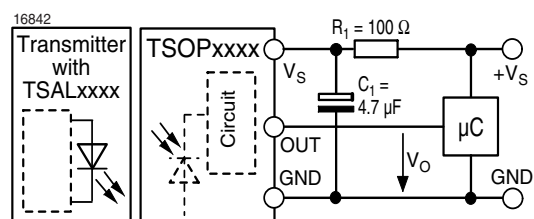

$R_1 + C_1$ recommended to suppress power supply disturbances.

The output voltage should not be hold continuously at a voltage below $V_O = 3.3$ V by the external circuit.

Absolute Maximum Ratings

Absolute Maximum Ratings

$T_{amb} = 25\text{ }^{\circ}\text{C}$, unless otherwise specified

Parameter	Test condition	Symbol	Value	Unit
Supply Voltage	(Pin 2)	V_S	- 0.3 to + 6.0	V
Supply Current	(Pin 2)	I_S	5	mA
Output Voltage	(Pin 1)	V_O	- 0.3 to + 6.0	V
Output Current	(Pin 1)	I_O	5	mA
Junction Temperature		T_j	100	$^{\circ}\text{C}$
Storage Temperature Range		T_{stg}	- 25 to + 85	$^{\circ}\text{C}$
Operating Temperature Range		T_{amb}	- 25 to + 85	$^{\circ}\text{C}$
Power Consumption	($T_{amb} \leq 85\text{ }^{\circ}\text{C}$)	P_{tot}	50	mW
Soldering Temperature	$t \leq 5\text{ s}$	T_{sd}	260	$^{\circ}\text{C}$

Electrical and Optical Characteristics

$T_{amb} = 25\text{ }^{\circ}\text{C}$, unless otherwise specified

Parameter	Test condition	Symbol	Min	Typ.	Max	Unit
Supply Current (Pin 2)	$V_S = 5\text{ V}$, $E_V = 0$	I_{SD}	0.8	1.2	1.5	mA
	$V_S = 5\text{ V}$, $E_V = 40\text{ klx}$, sunlight	I_{SH}		1.5		mA
Supply Voltage (Pin 2)		V_S	4.5		5.5	V
Transmission Distance	$E_V = 0$, test signal see fig.1, IR diode TSAL6200, $I_F = 250\text{ mA}$	d		35		m
Output Voltage Low (Pin 1)	$I_{OL} = 0.5\text{ mA}$, $E_e = 0.7\text{ mW/m}^2$, $f = f_o$	V_{OL}			250	mV
Minimum Irradiance (30 - 40 kHz)	Pulse width tolerance: $t_{pi} - 5/f_o < t_{po} < t_{pi} + 6/f_o$, test signal see fig.1	$E_{e\ min}$		0.2	0.4	mW/m^2
Minimum Irradiance (56 kHz)	Pulse width tolerance: $t_{pi} - 5/f_o < t_{po} < t_{pi} + 6/f_o$, test signal see fig.1	$E_{e\ min}$		0.3	0.5	mW/m^2
Maximum Irradiance	$t_{pi} - 5/f_o < t_{po} < t_{pi} + 6/f_o$	$E_{e\ max}$	30			W/m^2
Directivity	Angle of half transmission distance	$\phi_{1/2}$		± 45		deg

Typical Characteristics (Tamb = 25 °C unless otherwise specified)

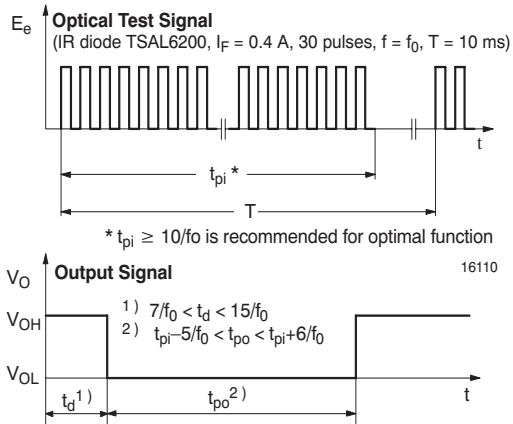

Figure 1. Output Function

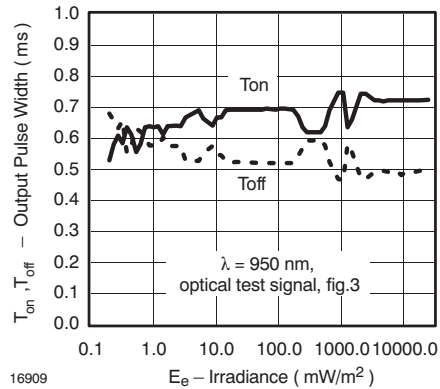

Figure 4. Output Pulse Diagram

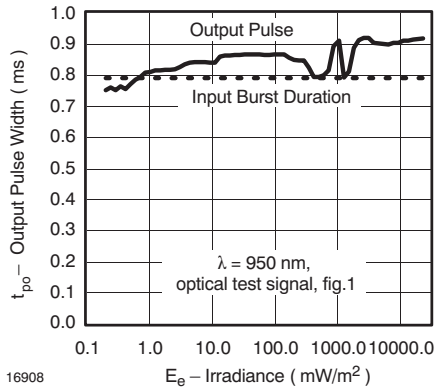

Figure 2. Pulse Length and Sensitivity in Dark Ambient

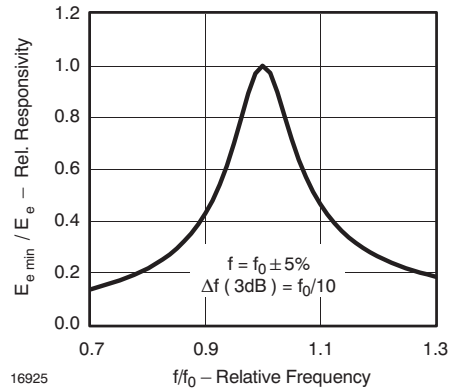

Figure 5. Frequency Dependence of Responsivity

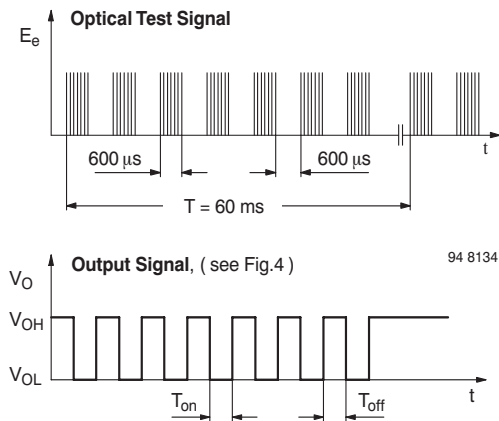

Figure 3. Output Function

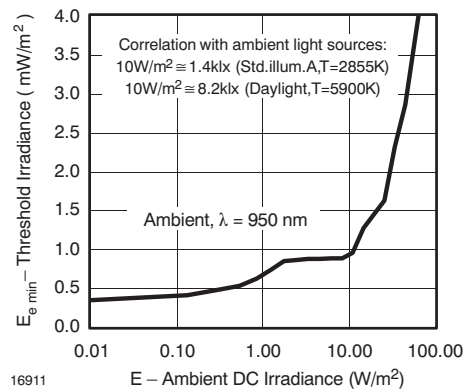
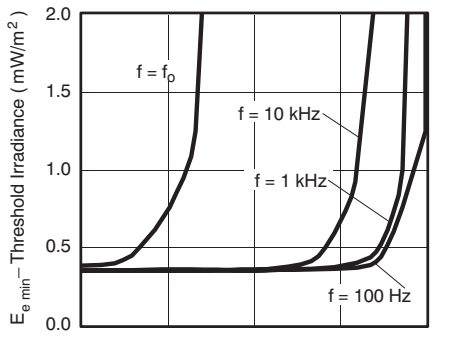
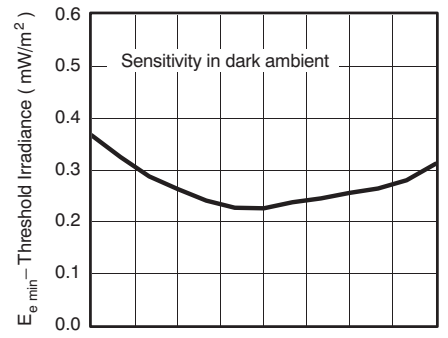

Figure 6. Sensitivity in Bright Ambient



16912 $\Delta V_{S,RMS}$ – AC Voltage on DC Supply Voltage (mV)

Figure 7. Sensitivity vs. Supply Voltage Disturbances



16918 T_{amb} – Ambient Temperature (°C)

Figure 10. Sensitivity vs. Ambient Temperature

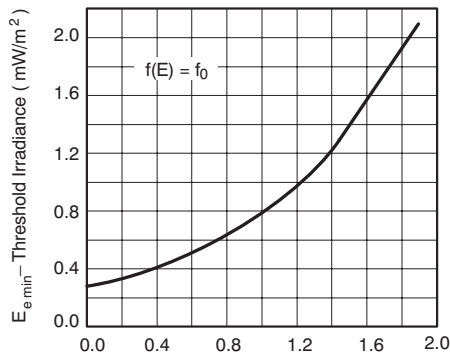

94 8147 E – Field Strength of Disturbance (kV/m)

Figure 8. Sensitivity vs. Electric Field Disturbances

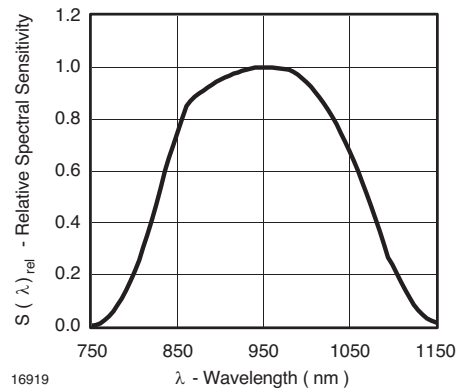

16919

Figure 11. Relative Spectral Sensitivity vs. Wavelength

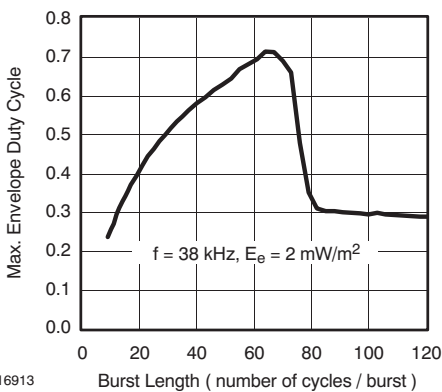

16913

Figure 9. Max. Envelope Duty Cycle vs. Burstlength

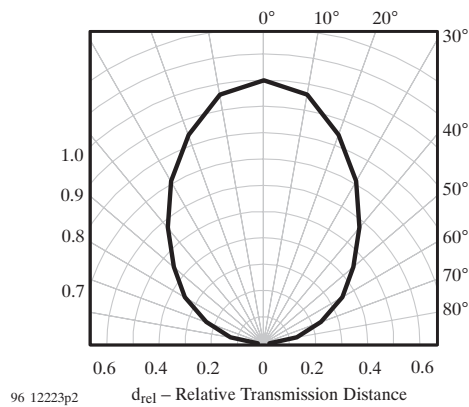

96 12223p2

Figure 12. Directivity

Suitable Data Format

The circuit of the TSOP22..MQ1 is designed in that way that unexpected output pulses due to noise or disturbance signals are avoided. A bandpass filter, an integrator stage and an automatic gain control are used to suppress such disturbances.

The distinguishing mark between data signal and disturbance signal are carrier frequency, burst length and duty cycle.

The data signal should fulfill the following conditions:

- Carrier frequency should be close to center frequency of the bandpass (e.g. 38 kHz).
- Burst length should be 10 cycles/burst or longer.
- After each burst which is between 10 cycles and 70 cycles a gap time of at least 14 cycles is necessary.
- For each burst which is longer than 1.8 ms a corresponding gap time is necessary at some time in the data stream. This gap time should be at least 4 times longer than the burst.
- Up to 800 short bursts per second can be received continuously.

Some examples for suitable data format are: NEC Code (repetitive pulse), NEC Code (repetitive data), Toshiba Micom Format, Sharp Code, RC5 Code, RC6 Code, R-2000 Code, Sony Code.

When a disturbance signal is applied to the TSOP22..MQ1 it can still receive the data signal. However the sensitivity is reduced to that level that no unexpected pulses will occur.

Some examples for such disturbance signals which are suppressed by the TSOP22..MQ1 are:

- DC light (e.g. from tungsten bulb or sunlight)
- Continuous signal at 38 kHz or at any other frequency
- Signals from fluorescent lamps with electronic ballast with high or low modulation (see Figure 13 or Figure 14).

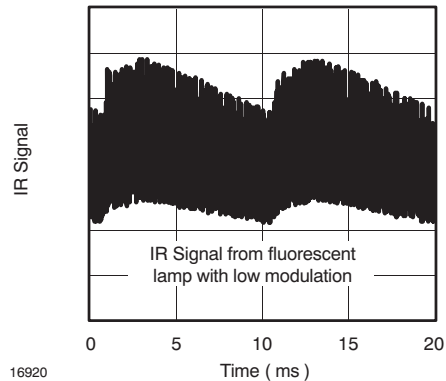

Figure 13. IR Signal from Fluorescent Lamp with low Modulation

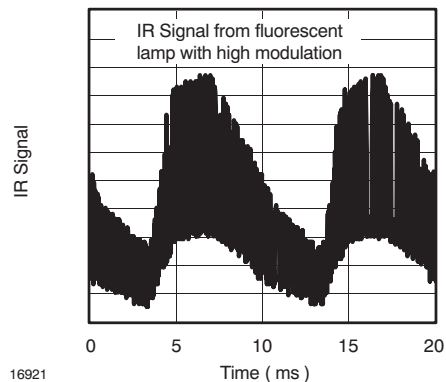

Figure 14. IR Signal from Fluorescent Lamp with high Modulation



Ozone Depleting Substances Policy Statement

It is the policy of Vishay Semiconductor GmbH to

1. Meet all present and future national and international statutory requirements.
2. Regularly and continuously improve the performance of our products, processes, distribution and operating systems with respect to their impact on the health and safety of our employees and the public, as well as their impact on the environment.

It is particular concern to control or eliminate releases of those substances into the atmosphere which are known as ozone depleting substances (ODSs).

The Montreal Protocol (1987) and its London Amendments (1990) intend to severely restrict the use of ODSs and forbid their use within the next ten years. Various national and international initiatives are pressing for an earlier ban on these substances.

Vishay Semiconductor GmbH has been able to use its policy of continuous improvements to eliminate the use of ODSs listed in the following documents.

1. Annex A, B and list of transitional substances of the Montreal Protocol and the London Amendments respectively
2. Class I and II ozone depleting substances in the Clean Air Act Amendments of 1990 by the Environmental Protection Agency (EPA) in the USA
3. Council Decision 88/540/EEC and 91/690/EEC Annex A, B and C (transitional substances) respectively.

Vishay Semiconductor GmbH can certify that our semiconductors are not manufactured with ozone depleting substances and do not contain such substances.

We reserve the right to make changes to improve technical design and may do so without further notice.

Parameters can vary in different applications. All operating parameters must be validated for each customer application by the customer. Should the buyer use Vishay Semiconductors products for any unintended or unauthorized application, the buyer shall indemnify Vishay Semiconductors against all claims, costs, damages, and expenses, arising out of, directly or indirectly, any claim of personal damage, injury or death associated with such unintended or unauthorized use.

Vishay Semiconductor GmbH, P.O.B. 3535, D-74025 Heilbronn, Germany
Telephone: 49 (0)7131 67 2831, Fax number: 49 (0)7131 67 2423



Notice

Specifications of the products displayed herein are subject to change without notice. Vishay Intertechnology, Inc., or anyone on its behalf, assumes no responsibility or liability for any errors or inaccuracies.

Information contained herein is intended to provide a product description only. No license, express or implied, by estoppel or otherwise, to any intellectual property rights is granted by this document. Except as provided in Vishay's terms and conditions of sale for such products, Vishay assumes no liability whatsoever, and disclaims any express or implied warranty, relating to sale and/or use of Vishay products including liability or warranties relating to fitness for a particular purpose, merchantability, or infringement of any patent, copyright, or other intellectual property right.

The products shown herein are not designed for use in medical, life-saving, or life-sustaining applications. Customers using or selling these products for use in such applications do so at their own risk and agree to fully indemnify Vishay for any damages resulting from such improper use or sale.