



Chipsmall Limited consists of a professional team with an average of over 10 year of expertise in the distribution of electronic components. Based in Hongkong, we have already established firm and mutual-benefit business relationships with customers from,Europe,America and south Asia,supplying obsolete and hard-to-find components to meet their specific needs.

With the principle of “Quality Parts,Customers Priority,Honest Operation,and Considerate Service”,our business mainly focus on the distribution of electronic components. Line cards we deal with include Microchip,ALPS,ROHM,Xilinx,Pulse,ON,Everlight and Freescale. Main products comprise IC,Modules,Potentiometer,IC Socket,Relay,Connector.Our parts cover such applications as commercial,industrial, and automotives areas.

We are looking forward to setting up business relationship with you and hope to provide you with the best service and solution. Let us make a better world for our industry!



Contact us

Tel: +86-755-8981 8866 Fax: +86-755-8427 6832

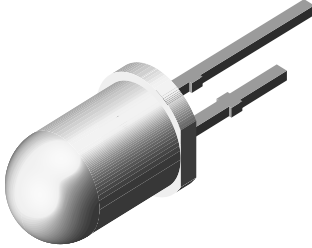
Email & Skype: info@chipsmall.com Web: www.chipsmall.com

Address: A1208, Overseas Decoration Building, #122 Zhenhua RD., Futian, Shenzhen, China





Infrared Emitting Diode, 950 nm, GaAs



94 8390

FEATURES

- Package type: leaded
- Package form: T-1 $\frac{3}{4}$
- Dimensions (in mm): \varnothing 5
- Leads with stand-off
- Peak wavelength: $\lambda_p = 950$ nm
- High reliability
- Angle of half intensity: $\varphi = \pm 15^\circ$
- Low forward voltage
- Suitable for high pulse current operation
- Good spectral matching with Si photodetectors
- Compliant to RoHS Directive 2002/95/EC and in accordance to WEEE 2002/96/EC



DESCRIPTION

TSUS5200 is an infrared, 950 nm emitting diode in GaAs technology molded in a blue-gray tinted plastic package.

Note

** Please see document "Vishay Material Category Policy": www.vishay.com/doc?99902

APPLICATIONS

- Infrared remote control and free air transmission systems with low forward voltage and small package requirements
- Emitter in transmissive sensors
- Emitter in reflective sensors

| PRODUCT SUMMARY | | | | |
|-----------------|---------------|-----------------|------------------|------------|
| COMPONENT | I_e (mW/sr) | φ (deg) | λ_p (nm) | t_r (ns) |
| TSUS5200 | 20 | ± 15 | 950 | 800 |
| TSUS5201 | 25 | ± 15 | 950 | 800 |
| TSUS5202 | 30 | ± 15 | 950 | 800 |

Note

- Test conditions see table "Basic Characteristics"

| ORDERING INFORMATION | | | |
|----------------------|-----------|------------------------------|-------------------|
| ORDERING CODE | PACKAGING | REMARKS | PACKAGE FORM |
| TSUS5200 | Bulk | MOQ: 4000 pcs, 4000 pcs/bulk | T-1 $\frac{3}{4}$ |
| TSUS5201 | Bulk | MOQ: 4000 pcs, 4000 pcs/bulk | T-1 $\frac{3}{4}$ |
| TSUS5202 | Bulk | MOQ: 4000 pcs, 4000 pcs/bulk | T-1 $\frac{3}{4}$ |

Note

- MOQ: minimum order quantity

| ABSOLUTE MAXIMUM RATINGS ($T_{amb} = 25^\circ\text{C}$, unless otherwise specified) | | | | |
|---|--|------------|---------------|------------------|
| PARAMETER | TEST CONDITION | SYMBOL | VALUE | UNIT |
| Reverse voltage | | V_R | 5 | V |
| Forward current | | I_F | 150 | mA |
| Peak forward current | $t_p/T = 0.5, t_p = 100 \mu\text{s}$ | I_{FM} | 300 | mA |
| Surge forward current | $t_p = 100 \mu\text{s}$ | I_{FSM} | 2.5 | A |
| Power dissipation | | P_V | 170 | mW |
| Junction temperature | | T_j | 100 | $^\circ\text{C}$ |
| Operating temperature range | | T_{amb} | - 40 to + 85 | $^\circ\text{C}$ |
| Storage temperature range | | T_{stg} | - 40 to + 100 | $^\circ\text{C}$ |
| Soldering temperature | $t \leq 5$ s, 2 mm from case | T_{sd} | 260 | $^\circ\text{C}$ |
| Thermal resistance junction/ambient | J-STD-051, leads 7 mm, soldered on PCB | R_{thJA} | 230 | K/W |

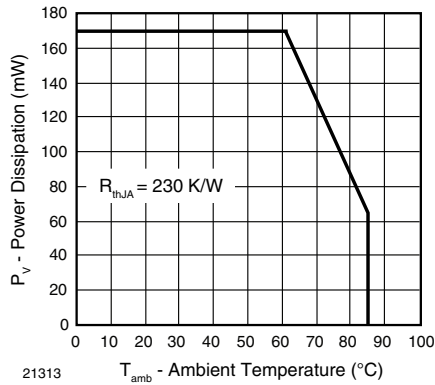


Fig. 1 - Power Dissipation Limit vs. Ambient Temperature

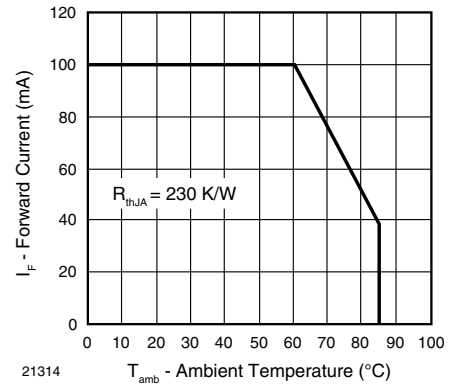


Fig. 1 - Forward Current Limit vs. Ambient Temperature

| BASIC CHARACTERISTICS (T _{amb} = 25 °C, unless otherwise specified) | | | | | | |
|--|---|-----------------------------|------|-------|------|------|
| PARAMETER | TEST CONDITION | SYMBOL | MIN. | TYP. | MAX. | UNIT |
| Forward voltage | I _F = 100 mA, t _p = 20 ms | V _F | | 1.3 | 1.7 | V |
| Temperature coefficient of V _F | I _F = 100 mA | TK _{V_F} | | - 1.3 | | mV/K |
| Reverse current | V _R = 5 V | I _R | | | 100 | μA |
| Junction capacitance | V _R = 0 V, f = 1 MHz, E = 0 | C _j | | 30 | | pF |
| Temperature coefficient of φ _e | I _F = 20 mA | TK _{φ_e} | | - 0.8 | | %/K |
| Angle of half intensity | | φ | | ± 15 | | deg |
| Peak wavelength | I _F = 100 mA | λ _p | | 950 | | nm |
| Spectral bandwidth | I _F = 100 mA | Δλ | | 50 | | nm |
| Temperature coefficient of λ _p | I _F = 100 mA | TK _{λ_p} | | 0.2 | | nm/K |
| Rise time | I _F = 100 mA | t _r | | 800 | | ns |
| | I _F = 1.5 A | t _r | | 400 | | ns |
| Fall time | I _F = 100 mA | t _f | | 800 | | ns |
| | I _F = 1.5 A | t _f | | 400 | | ns |
| Virtual source diameter | | d | | 3.8 | | mm |

| TYPE DEDICATED CHARACTERISTICS ($T_{amb} = 25\text{ }^{\circ}\text{C}$, unless otherwise specified) | | | | | | | |
|---|---|----------|----------|------|------|------|-------|
| PARAMETER | TEST CONDITION | PART | SYMBOL | MIN. | TYP. | MAX. | UNIT |
| Forward voltage | $I_F = 1.5\text{ A}$, $t_p = 100\text{ }\mu\text{s}$ | TSUS5200 | V_F | | 2.2 | 3.4 | V |
| | | TSUS5201 | V_F | | 2.2 | 3.4 | V |
| | | TSUS5202 | V_F | | 2.2 | 2.7 | V |
| Radiant intensity | $I_F = 100\text{ mA}$, $t_p = 20\text{ ms}$ | TSUS5200 | I_e | 10 | 20 | 50 | mW/sr |
| | | TSUS5201 | I_e | 15 | 25 | 50 | mW/sr |
| | | TSUS5202 | I_e | 20 | 30 | 50 | mW/sr |
| | $I_F = 1.5\text{ A}$, $t_p = 100\text{ }\mu\text{s}$ | TSUS5200 | I_e | 95 | 180 | | mW/sr |
| | | TSUS5201 | I_e | 120 | 230 | | mW/sr |
| | | TSUS5202 | I_e | 170 | 280 | | mW/sr |
| Radiant power | $I_F = 100\text{ mA}$, $t_p = 20\text{ ms}$ | TSUS5200 | ϕ_e | | 13 | | mW |
| | | TSUS5201 | ϕ_e | | 14 | | mW |
| | | TSUS5202 | ϕ_e | | 15 | | mW |

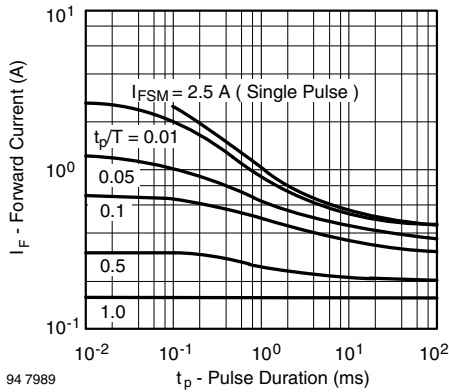
BASIC CHARACTERISTICS ($T_{amb} = 25\text{ }^{\circ}\text{C}$, unless otherwise specified)


Fig. 2 - Pulse Forward Current vs. Pulse Duration

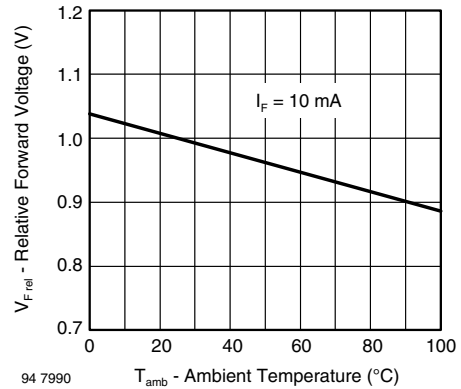


Fig. 4 - Relative Forward Voltage vs. Ambient Temperature

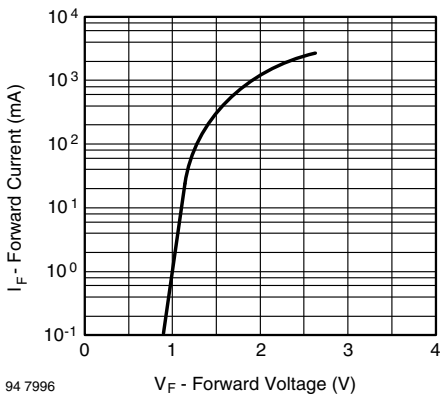


Fig. 3 - Forward Current vs. Forward Voltage

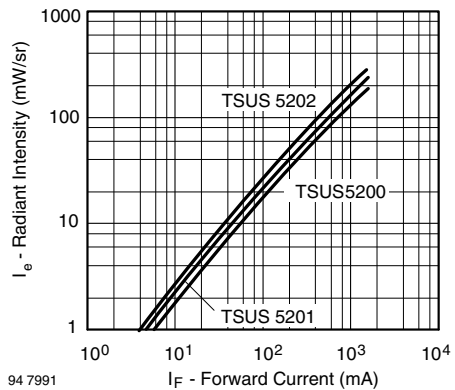


Fig. 5 - Radiant Intensity vs. Forward Current

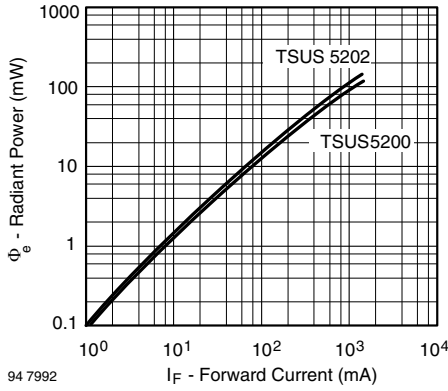


Fig. 6 - Radiant Power vs. Forward Current

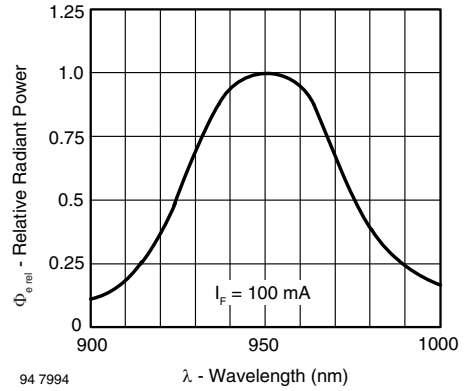


Fig. 8 - Relative Radiant Power vs. Wavelength

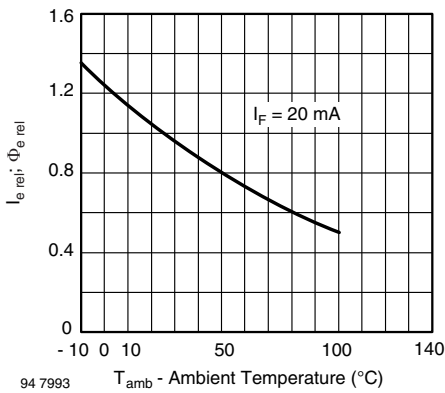


Fig. 7 - Relative Radiant Intensity/Power vs. Ambient Temperature

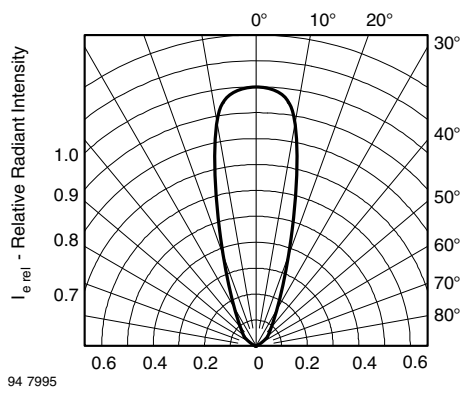
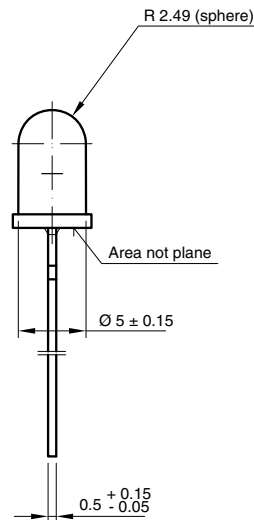
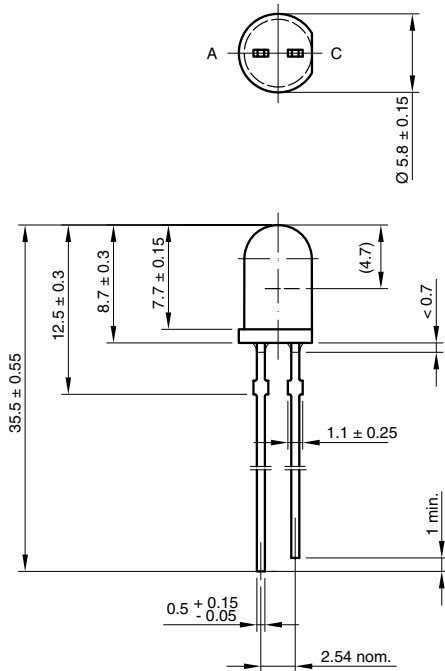


Fig. 9 - Relative Radiant Intensity vs. Angular Displacement

PACKAGE DIMENSIONS in millimeters



technical drawings according to DIN specifications

6.544-5258.02-4
Issue: 7; 23.07.10
95 10916



Disclaimer

ALL PRODUCT, PRODUCT SPECIFICATIONS AND DATA ARE SUBJECT TO CHANGE WITHOUT NOTICE TO IMPROVE RELIABILITY, FUNCTION OR DESIGN OR OTHERWISE.

Vishay Intertechnology, Inc., its affiliates, agents, and employees, and all persons acting on its or their behalf (collectively, "Vishay"), disclaim any and all liability for any errors, inaccuracies or incompleteness contained in any datasheet or in any other disclosure relating to any product.

Vishay makes no warranty, representation or guarantee regarding the suitability of the products for any particular purpose or the continuing production of any product. To the maximum extent permitted by applicable law, Vishay disclaims (i) any and all liability arising out of the application or use of any product, (ii) any and all liability, including without limitation special, consequential or incidental damages, and (iii) any and all implied warranties, including warranties of fitness for particular purpose, non-infringement and merchantability.

Statements regarding the suitability of products for certain types of applications are based on Vishay's knowledge of typical requirements that are often placed on Vishay products in generic applications. Such statements are not binding statements about the suitability of products for a particular application. It is the customer's responsibility to validate that a particular product with the properties described in the product specification is suitable for use in a particular application. Parameters provided in datasheets and / or specifications may vary in different applications and performance may vary over time. All operating parameters, including typical parameters, must be validated for each customer application by the customer's technical experts. Product specifications do not expand or otherwise modify Vishay's terms and conditions of purchase, including but not limited to the warranty expressed therein.

Except as expressly indicated in writing, Vishay products are not designed for use in medical, life-saving, or life-sustaining applications or for any other application in which the failure of the Vishay product could result in personal injury or death. Customers using or selling Vishay products not expressly indicated for use in such applications do so at their own risk. Please contact authorized Vishay personnel to obtain written terms and conditions regarding products designed for such applications.

No license, express or implied, by estoppel or otherwise, to any intellectual property rights is granted by this document or by any conduct of Vishay. Product names and markings noted herein may be trademarks of their respective owners.