



Chipsmall Limited consists of a professional team with an average of over 10 year of expertise in the distribution of electronic components. Based in Hongkong, we have already established firm and mutual-benefit business relationships with customers from,Europe,America and south Asia,supplying obsolete and hard-to-find components to meet their specific needs.

With the principle of “Quality Parts,Customers Priority,Honest Operation,and Considerate Service”,our business mainly focus on the distribution of electronic components. Line cards we deal with include Microchip,ALPS,ROHM,Xilinx,Pulse,ON,Everlight and Freescale. Main products comprise IC,Modules,Potentiometer,IC Socket,Relay,Connector.Our parts cover such applications as commercial,industrial, and automotives areas.

We are looking forward to setting up business relationship with you and hope to provide you with the best service and solution. Let us make a better world for our industry!



Contact us

Tel: +86-755-8981 8866 Fax: +86-755-8427 6832

Email & Skype: info@chipsmall.com Web: www.chipsmall.com

Address: A1208, Overseas Decoration Building, #122 Zhenhua RD., Futian, Shenzhen, China



REV.	N° DCR	NATURE DE LA MODIFICATION	DATE	VISA
A	ECR-4981	Suppression reference 43 TA3 A00 FP	23/06/2010	L.B

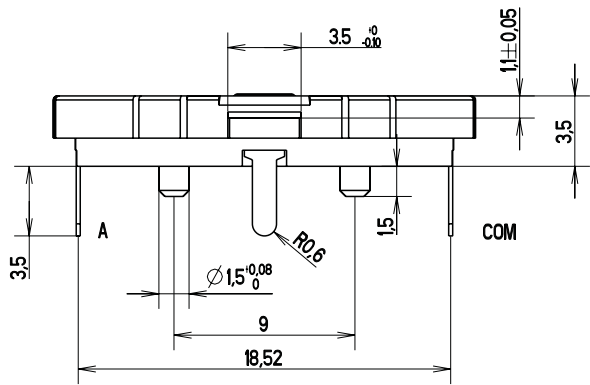

COVER DESIGN GUIDELINE

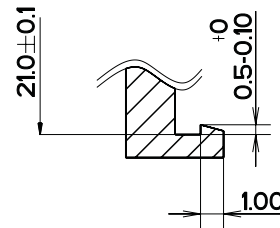

CONTACT CONFIGURATION

Push



Rotation output waveform

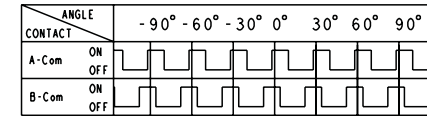

CW ← → CCW

Numbers of detent : 24

Pulse/Rotation : 12 pulse/360°

1

2

3

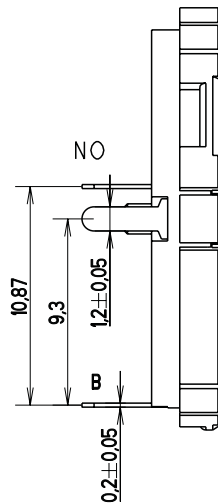
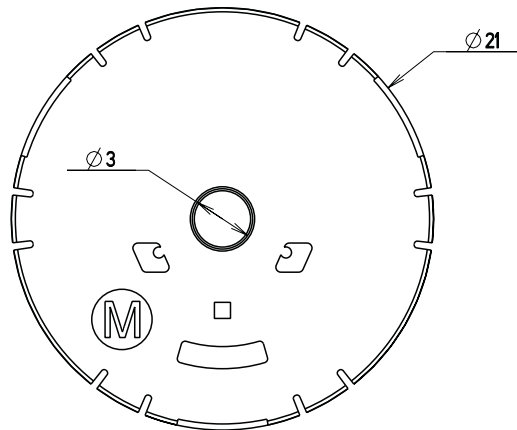

PCB LAYOUT

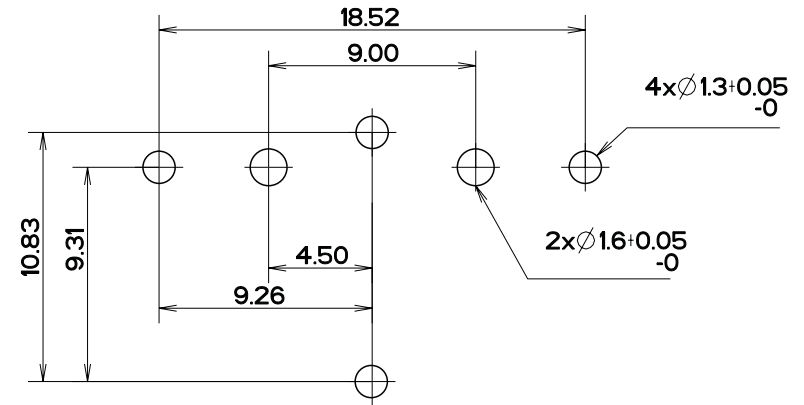

Reference	Designation
43 TA3 C00 FP	TSW A-3N-C LFS

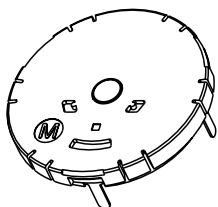

ECHELLE 2,000

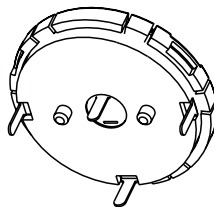

MATERIAL / VOLUME	TREATMENT	PROTECTION
UNLESS OTHERWISE : - DIMENSIONS GIVEN BEFORE PROTECTION - BURRS AND SHARP EDGES DELETED	LINEAR TOLERANCE ± 0.4 ANGULAR TOLERANCE ± 1° SURFACE FINISH Ra	CRITICAL DIMENSIONS 0 SPC DIMENSIONS 0
CREATE BY JUILLE P DATE 07/09/2009	MODIFICATION see revision table on the first sheet REPLACE	
CHECKED BY KUBAT L DATE	FILENAME 43MTA001FP.KPLUAE FOLDER Dossier racine/dole_south.rd/zippy/bouton/produit	
APPROVED BY Laurent Kubit DATE 2010.06.24 08:52:15 +02'00'	PART DESCRIPTION Tact and Scroll Wheel TYPE A	
G&K Components C&K Components	SCALE 4,000	
BP 359 - 39105 Dole - FRANCE -	SIZE A3 SHEET 1 / 1	PART NUMBER CU 43 MTA 001 FP REV A

A

B

C

D

E

F

1

2

3

4