



Chipsmall Limited consists of a professional team with an average of over 10 year of expertise in the distribution of electronic components. Based in Hongkong, we have already established firm and mutual-benefit business relationships with customers from,Europe,America and south Asia,supplying obsolete and hard-to-find components to meet their specific needs.

With the principle of “Quality Parts,Customers Priority,Honest Operation,and Considerate Service”,our business mainly focus on the distribution of electronic components. Line cards we deal with include Microchip,ALPS,ROHM,Xilinx,Pulse,ON,Everlight and Freescale. Main products comprise IC,Modules,Potentiometer,IC Socket,Relay,Connector.Our parts cover such applications as commercial,industrial, and automotives areas.

We are looking forward to setting up business relationship with you and hope to provide you with the best service and solution. Let us make a better world for our industry!



Contact us

Tel: +86-755-8981 8866 Fax: +86-755-8427 6832

Email & Skype: info@chipsmall.com Web: www.chipsmall.com

Address: A1208, Overseas Decoration Building, #122 Zhenhua RD., Futian, Shenzhen, China





T1/E1/PRI-ISDN/CEPT Magnetic Module, Multi Port, 40 pin SMD

MODEL NUMBER
TTC-6021

- Surface Mount Device withstands IR reflow profile process
- Operating temperature: -40°C to +85°C

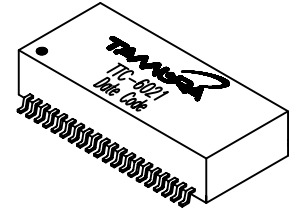

Electrical Specification from 0°C to +70°C						@ -40°C
DCR (ΩMax)	Crosstalk (dB Min)	OCL (mH Min)	Hipot (Vrms)	Leakage Inductance (μH Max)	Cww (pF Max)	OCL (mH Min)
Primary	0.1-10 MHz	Primary 100KHz 0.1Vrms	60 sec	100KHz 0.1Vrms	100KHz 0.1Vrms	Primary 100KHz 0.1Vrms
0.8	-35	1.2	1500	0.5	35	0.6

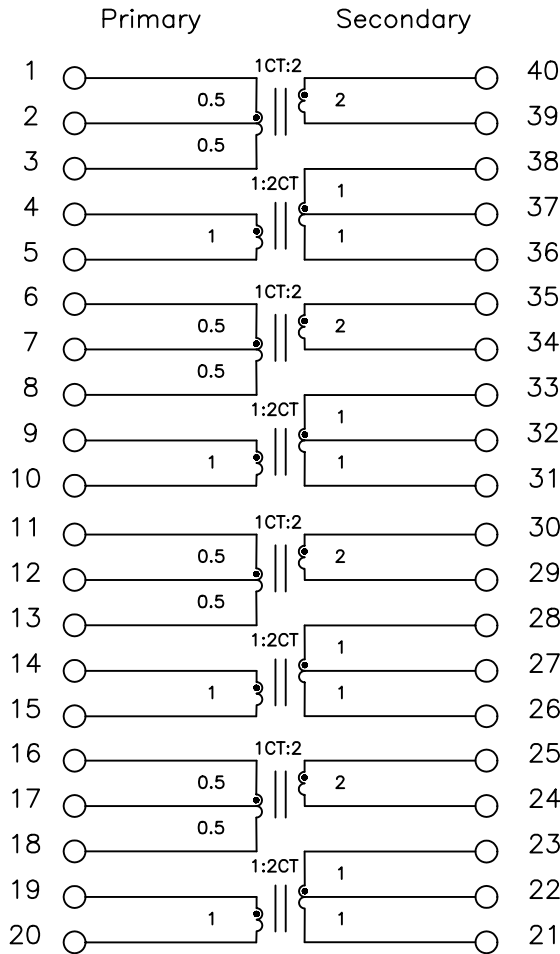

PREPARED BY:

D. Rund

ENGINEER:

L. Le

QUALITY CONTROL:

T. Clem

APPROVED:

J. Coleman

DWG CONTROL NO.
P-A1-12874
ACAD\TTC\A1128741.DWG

REV
-

T1/E1/PRI-ISDN/CEPT MAGNETIC MODULE
MULTI PORT, 40 PIN SMD

TAMURA CORPORATION OF AMERICA
43352 BUSINESS PARK DRIVE, TEMECULA, CA. 92590-6624
(909) 699-1270 FAX 9096769482

TTC-6021

MODEL SPECIFICATION

DIM: MM[IN] | SCL: NONE | SH: 1 OF 2

PROPRIETARY NOTICE: THIS DRAWING PRINT OR DOCUMENT AND SUBJECT MATTER DISCLOSED HEREIN ARE PROPRIETARY ITEMS TO WHICH TAMURA RETAINS THE EXCLUSIVE RIGHT OF DISSEMINATION, REPRODUCTION, MANUFACTURE AND SALE. THIS DRAWING, PRINT OR DOCUMENT IS SUBMITTED IN CONFIDENCE FOR CONSIDERATION BY THE RECIPIENT ALONE UNLESS PERMISSION FOR FURTHER DISCLOSURE IS EXPRESSLY GRANTED IN WRITING.



T1/E1/PRI-ISDN/CEPT Magnetic
Module, Multi Port, 40 pin SMD

MODEL NUMBER
TTC-6021

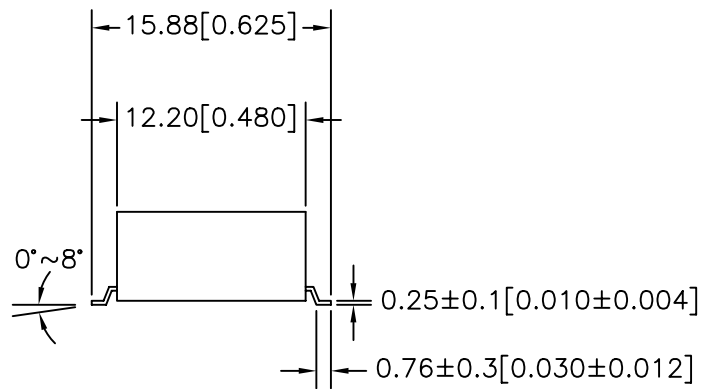
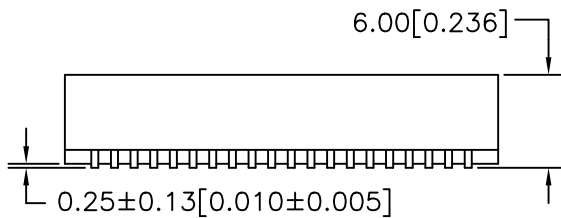
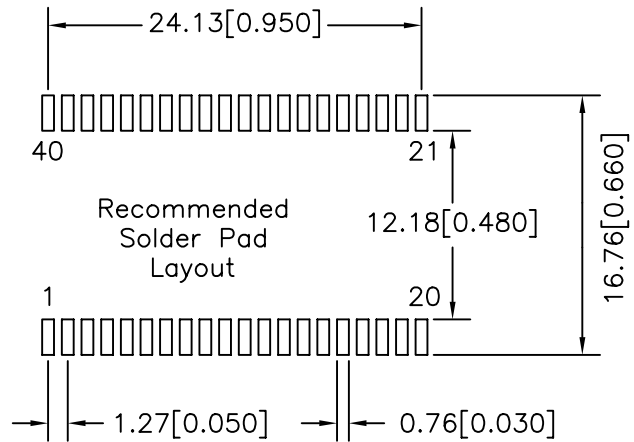
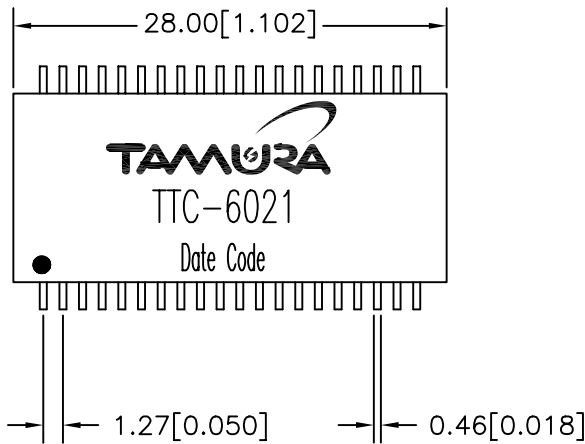
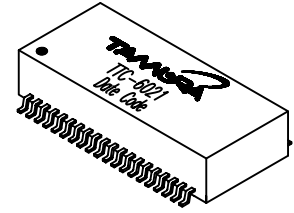

PREPARED BY:

D. Rund

ENGINEER:

L. Le

QUALITY CONTROL:

T. Clem

APPROVED:

J. Coleman

NOTE: Unless otherwise specified, all dimensions are mm[in] with tolerance of ±0.25[0.010]

DWG CONTROL NO. P-A1-12874 ACAD\TTC\A1128742.DWG	REV -	T1/E1/PRI-ISDN/CEPT MAGNETIC MODULE MULTI PORT, 40 PIN SMD
--	----------	---

TTC-6021

MODEL SPECIFICATION

TAMURA CORPORATION OF AMERICA
43352 BUSINESS PARK DRIVE, TEMECULA, CA. 92590-6624
(909) 699-1270 FAX 9096769482

DIM: MM[IN] | SCL: NONE | SH: 2 OF 2

PROPRIETARY NOTICE: THIS DRAWING PRINT OR DOCUMENT AND SUBJECT MATTER DISCLOSED HEREIN ARE PROPRIETARY ITEMS TO WHICH TAMURA RETAINS THE EXCLUSIVE RIGHT OF DISSEMINATION, REPRODUCTION, MANUFACTURE AND SALE. THIS DRAWING, PRINT OR DOCUMENT IS SUBMITTED IN CONFIDENCE FOR CONSIDERATION BY THE RECIPIENT ALONE UNLESS PERMISSION FOR FURTHER DISCLOSURE IS EXPRESSLY GRANTED IN WRITING.