



Chipsmall Limited consists of a professional team with an average of over 10 year of expertise in the distribution of electronic components. Based in Hongkong, we have already established firm and mutual-benefit business relationships with customers from,Europe,America and south Asia,supplying obsolete and hard-to-find components to meet their specific needs.

With the principle of “Quality Parts,Customers Priority,Honest Operation,and Considerate Service”,our business mainly focus on the distribution of electronic components. Line cards we deal with include Microchip,ALPS,ROHM,Xilinx,Pulse,ON,Everlight and Freescale. Main products comprise IC,Modules,Potentiometer,IC Socket,Relay,Connector.Our parts cover such applications as commercial,industrial, and automotives areas.

We are looking forward to setting up business relationship with you and hope to provide you with the best service and solution. Let us make a better world for our industry!



Contact us

Tel: +86-755-8981 8866 Fax: +86-755-8427 6832

Email & Skype: info@chipsmall.com Web: www.chipsmall.com

Address: A1208, Overseas Decoration Building, #122 Zhenhua RD., Futian, Shenzhen, China



REV. Status

PRELIMINARY
10/23/00 LL

PRELIMINARY 1
CHANGED PIN
STYLE
11/28/00 LL

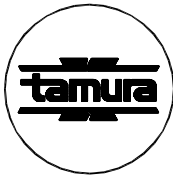

10/100 Base-T LAN Magnetic Module Single Port, 16 pin SMD

MODEL NUMBER
TTC-8103

- Complies with IEEE 802.3 Standard
- Surface Mount Device withstands IR reflow profile process
- Operating temperature: 0°C to 70°C
- Enhanced Common Mode Attenuation

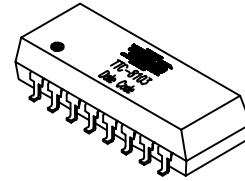

Electrical Specification @ 25°C							
Insertion Loss (dB Max)	Return Loss (dB Min)			CMRR (dB Min)	Crosstalk (dB Min)	OCL (μH Min)	Hipot (Vrms)
0.1-100 MHz	0.1-30 MHz	60 MHz	80 MHz	0.1-100 MHz	0.1-100 MHz	8mA DC Bias	60 sec
-1	-18	-14	-12	-35	-35	350	1500

RY
R
A
Z
I
N
E
R
E

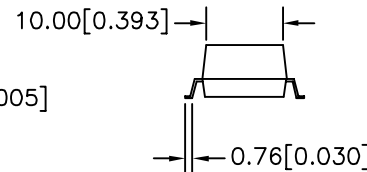
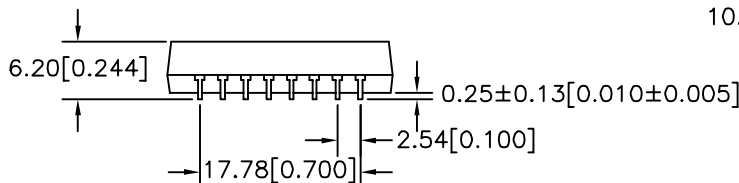
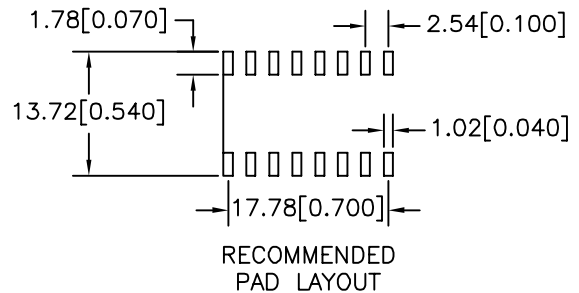
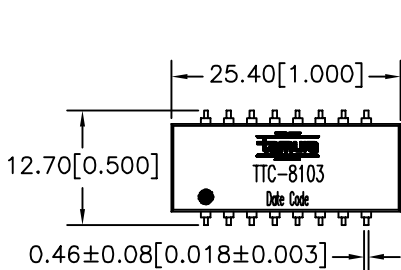
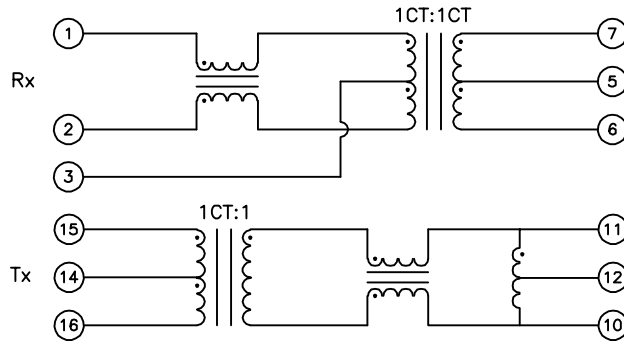

NOTE: Unless otherwise specified, all dimensions are mm[in] with tolerance of ±0.25[0.010]

PREPARED BY:

D. Rund

ENGINEER:

L. Le

QUALITY CONTROL:

D. Kelley

APPROVED:

J. Coleman

DWG CONTROL NO. P-A1-12617
ACAD\TTC\A1126171.DWG

REV PR1

10/100 Base-T LAN Magnetic Module
Single Port, 16 pin SMD

CONTENTS OF THIS DRAWING ARE SUBJECT TO CHANGE WITHOUT PRIOR NOTICE

TAMURA CORPORATION OF AMERICA
43352 BUSINESS PARK DRIVE, TEMECULA, CA. 92590-6624
(909) 699-1270 FAX 9096769482

TTC-8103

MODEL SPECIFICATION

DIM: mm(In) SCL: none SH: 1 OF 1

PROPRIETARY NOTICE: THIS DRAWING PRINT OR DOCUMENT AND SUBJECT MATTER DISCLOSED HEREIN ARE PROPRIETARY ITEMS TO WHICH TAMURA RETAINS THE EXCLUSIVE RIGHT OF DISSEMINATION, REPRODUCTION, MANUFACTURE AND SALE. THIS DRAWING, PRINT OR DOCUMENT IS SUBMITTED IN CONFIDENCE FOR CONSIDERATION BY THE RECIPIENT ALONE UNLESS PERMISSION FOR FURTHER DISCLOSURE IS EXPRESSLY GRANTED IN WRITING.