



Chipsmall Limited consists of a professional team with an average of over 10 year of expertise in the distribution of electronic components. Based in Hongkong, we have already established firm and mutual-benefit business relationships with customers from,Europe,America and south Asia,supplying obsolete and hard-to-find components to meet their specific needs.

With the principle of “Quality Parts,Customers Priority,Honest Operation,and Considerate Service”,our business mainly focus on the distribution of electronic components. Line cards we deal with include Microchip,ALPS,ROHM,Xilinx,Pulse,ON,Everlight and Freescale. Main products comprise IC,Modules,Potentiometer,IC Socket,Relay,Connector.Our parts cover such applications as commercial,industrial, and automotives areas.

We are looking forward to setting up business relationship with you and hope to provide you with the best service and solution. Let us make a better world for our industry!



Contact us

Tel: +86-755-8981 8866 Fax: +86-755-8427 6832

Email & Skype: info@chipsmall.com Web: www.chipsmall.com

Address: A1208, Overseas Decoration Building, #122 Zhenhua RD., Futian, Shenzhen, China





GD Series - Page A3



GDH Series - Page A5



AD Series - Page A7

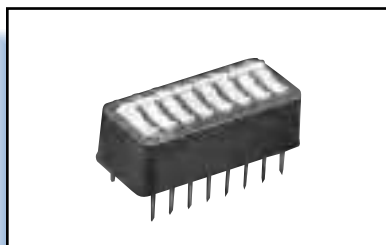

7000 Series - Page A11



7100 Series - Page A17



S Series - Page A18



MRD Series - Page A21



DRD Series - Page A23

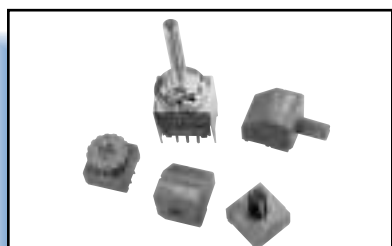

DR Series - Page A25

DIP Switches

A
DIP Switches

DIP Switch Part Number Index

ADE02A7	ADF07A8	ADPA05SA9	GDR02A5
ADE02SA7	ADF07SA8	ADPA05SAA9	GDR02SA5
ADE02SAA7	ADF07SAA8	ADPA06A9	GDR04A5
ADE03A7	ADF07SATA8	ADPA06SA9	GDR04SA5
ADE03SA7	ADF07STA8	ADPA06SAA9	GDR06A5
ADE03SAA7	ADF07STTRA8	ADPA07A9	GDR06SA5
ADE04A7	ADF07TA8	ADPA07SA9	GDR08A5
ADE04SA7	ADF08A8	ADPA07SAA9	GDR08SA5
ADE04SAA7	ADF08SA8	ADPA08A9	GDR10A5
ADE05A7	ADF08SAA8	ADPA08SA9	GDR10SA5
ADE05SA7	ADF08SATA8	ADPA08SAA9	GDS02A3
ADE05SAA7	ADF08STA8	ADPA09A9	GDS02NTSA3
ADE06A7	ADF08STTRA8	ADPA09SA9	GDS02SA3
ADE06SA7	ADF08TA8	ADPA09SAA9	GDS02STRA3
ADE06SAA7	ADF09A8	ADPA10A9	GDS04A3
ADE07A7	ADF09SA8	ADPA10SA9	GDS04NTSA3
ADE07SA7	ADF09SAA8	ADPA10SAA9	GDS04SA3
ADE07SAA7	ADF09SATA8	APD10SAA9	GDS04STRA3
ADE08A7	ADF09STA8	DRD*RAEA25	GDS06A3
ADE08SA7	ADF09STTRA8	DRD10CEA23	GDS06NTSA3
ADE08SAA7	ADF09TA8	DRD10CESA23	GDS06SA3
ADE09A7	ADF10A8	DRD10EA23	GDS06STRA3
ADE09SA7	ADF10SA8	DRD10ESA23	GDS08A3
ADE09SAA7	ADF10SAA8	DRD16CEA23	GDS08NTSA3
ADE10A7	ADF10SATA8	DRD16CESA23	GDS08SA3
ADE10SA7	ADF10STA8	DRD16EA23	GDS08STRA3
ADE10SAA7	ADF10STTRA8	DRD16ESA23	GDS10A3
ADE12A7	ADF10TA8	DRMA25	GDS10SA3
ADE12SA7	ADF12A8	DRSA25	GDS10STRA3
ADE12SAA7	ADF12SA8	DRWA25	MGDH04A6
ADF02A8	ADF12SAA8	GDB02A4	MRD10A21
ADF02SA8	ADF12SATA8	GDB02SA4	MRD10SA21
ADF02SAA8	ADF12STA8	GDB04A4	MRD16CA21
ADF02SATA8	ADF12STTRA8	GDB04SA4	MRD16SA21
ADF02STA8	ADF12TA8	GDB06A4	SLV04A18
ADF02STTRA8	ADP02A9	GDB06SA4	SLV06A18
ADF02TA8	ADP02SA9	GDB08A4	SSH02A18
ADF03A8	ADP02SAA9	GDB08SA4	SSH04A18
ADF03SA8	ADP04A9	GDB10A4	SSH06A18
ADF03SAA8	ADP04SA9	GDB10SA4	SSH08A18
ADF03SATA8	ADP04SAA9	GDH02SA5	SSH10A18
ADF03STA8	ADP05A9	GDH02STRA5	SSV02A18
ADF03STTRA8	ADP05SA9	GDH04SA5	SSV04A18
ADF03TA8	ADP05SAA9	GDH04STRA5	SSV06A18
ADF04A8	ADP06A9	GDH06SA5	SSV08A18
ADF04SA8	ADP06SA9	GDH06STRA5	SSV10A18
ADF04SAA8	ADP06SAA9	GDH08SA5	435166A15
ADF04SATA8	ADP07A9	GDH08STRA5	435469A14
ADF04STA8	ADP07SA9	GDH10SA5	435470A13
ADF04STTRA8	ADP07SAA9	GDH10STRA5	435626A15
ADF04TA8	ADP08A9	GDP02A4	435640A17
ADF05A8	ADP08SA9	GDP02NTSA4	435668A17
ADF05SA8	ADP08SAA9	GDP02SA4	435704A20
ADF05SAA8	ADP09A9	GDP02STRA4	435802A12
ADF05SATA8	ADP09SA9	GDP04A4	436860A20
ADF05STA8	ADP09SAA9	GDP04NTSA4		
ADF05STTRA8	ADP10A9	GDP04SA4		
ADF05TA8	ADP10SA9	GDP06A4		
ADF06A8	ADPA02A9	GDP06SA4		
ADF06SA8	ADPA02SA9	GDP08A4		
ADF06SAA8	ADPA02SAA9	GDP08SA4		
ADF06SATA8	ADPA04A9	GDP08STRA4		
ADF06STA8	ADPA04SA9	GDP10A4		
ADF06STTRA8	ADPA04SAA9	GDP10SA4		
ADF06TA8	ADPA05A9	GDP10STRA4		

DIP Switches, Low Profile, Slide Actuator, Through Hole and Surface Mount

FEATURES:

- Conventional gold wiping contact system
- Available in PC and surface mount configurations
- Traditional tape seal standard
- 95% Minimum solder coverage (90/10 tin lead)
- Withstands wave soldering temperature of 245°C for 3-5 seconds
- Heat deflection temperature of 260°C for surface mount compatibility
- End stackable (GDS version)
- Auto-insertable (GDS and GDB version)
- Vacuum pick and place compatible (GDS, GDB and GDH)
- Half pitch .050" terminal spacing (GDH version)
- Available in optional tape & reel packaging
- Shipped in the off position

MATERIAL SPECIFICATIONS:

Moving ContactGold over nickel over copper alloy
 Fixed ContactGold over nickel over copper alloy
 Base MaterialPPS UL94V-0
 Cover MaterialPPS UL94V-0
 Actuator MaterialHigh temperature polyester/polyamide
 TerminalTin lead plated over nickel over copper alloy

TYPICAL PERFORMANCE CHARACTERISTICS:

Contact Rating0.4 VA @ 24 VDC
 Initial Contact Resistance100 Milliohms max.
 Insulation Resistance100 Megohms min. @ 250 VDC
 Dielectric Strength300 VAC
 Life Expectancy1,000 Cycles
 Operating Force60-600 Grams

ENVIRONMENTAL SPECIFICATIONS:

Operating Temperature-30°C to +85°C
 Storage Temperature-45°C to +100°C
 Solder Heat ResistanceSee page M3-4

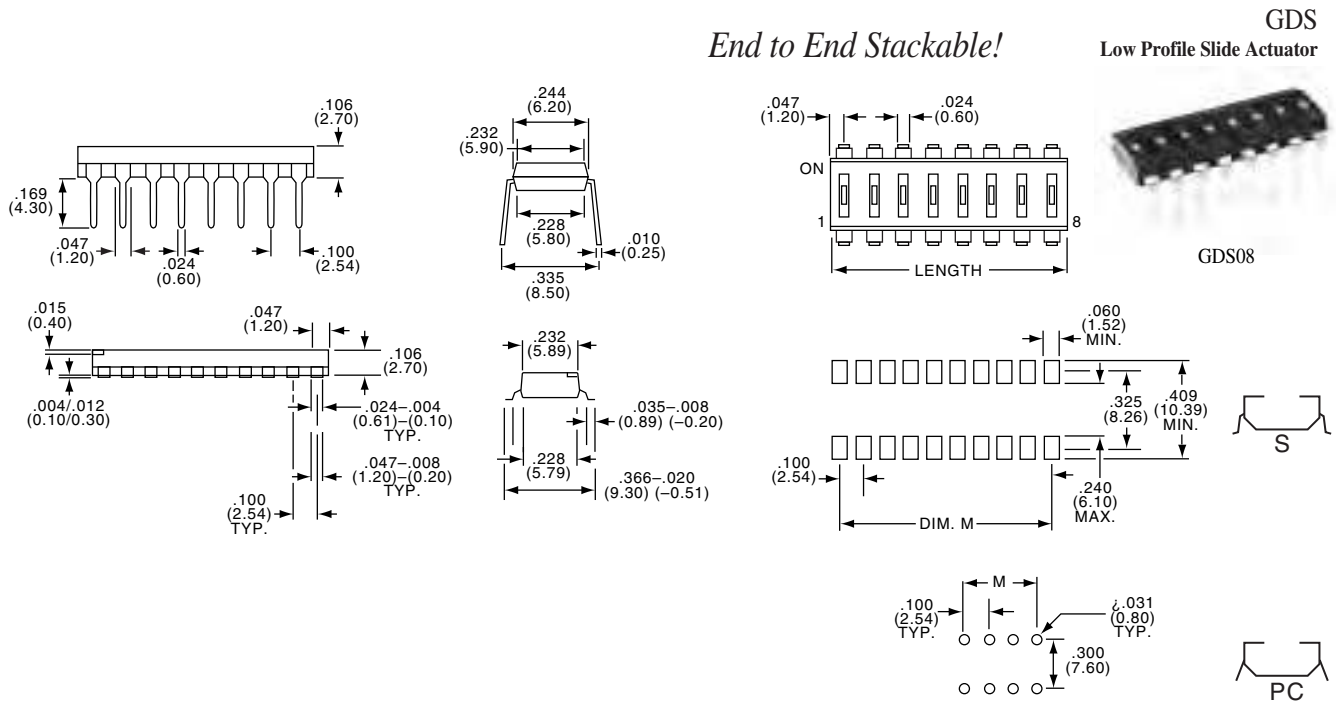

Part Number								Poles	Length	Dim. M
PC Model		S Model		Tape & Reel		S Model No Tape				
Tyco Electronics	Alcoswitch	Tyco Electronics	Alcoswitch	Tyco Electronics	Alcoswitch	Tyco Electronics	Alcoswitch			
5-1437590-5	GDS02	5-1437590-7	GDS02S	5-1437590-8	GDS02STR	5-1437590-6	GDS02NTS	2	.194(4.94)	.100(2.54)
5-1437590-9	GDS04	6-1437590-1	GDS04S	6-1437590-2	GDS04STR	6-1437590-0	GDS04NTS	4	.394(10.02)	.300(7.62)
6-1437590-3	GDS06	6-1437590-5	GDS06S	6-1437590-6	GDS06STR	6-1437590-4	GDS06NTS	6	.594(15.10)	.500(12.7)
6-1437590-7	GDS08	6-1437590-9	GDS08S	7-1437590-0	GDS08STR	6-1437590-8	GDS08NTS	8	.794(20.18)	.700(17.78)
7-1437590-1	GDS10	7-1437590-2	GDS10S	7-1437590-3	GDS10STR	—	—	10	.994(25.26)	.900(22.86)

A

GD Series

DIP Switches, Piano Actuator, Through Hole and Surface Mount

SEE PAGE A3 FOR PRODUCT SPECIFICATIONS

GDP

Classic Profile Piano Actuator



GDP08

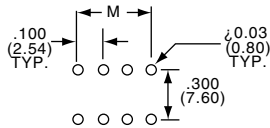
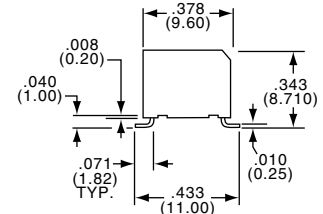
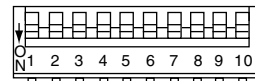
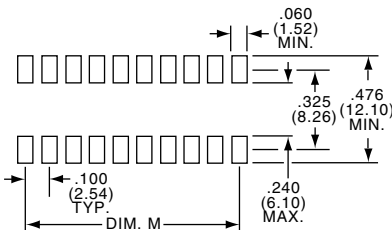
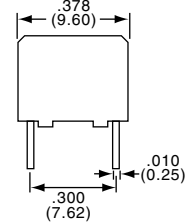
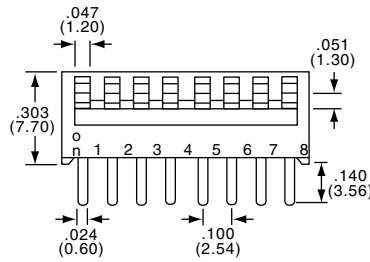
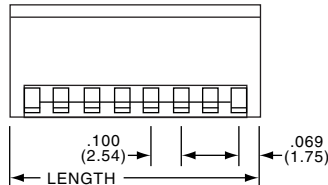
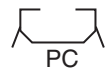
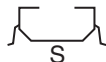

Part Number								Poles	Length	Dim. M
PC Model		S Model		Tape and Reel		S Model No Tape				
Tyco Electronics	Alcoswitch	Tyco Electronics	Alcoswitch	Tyco Electronics	Alcoswitch	Tyco Electronics	Alcoswitch			
3-1437590-2	GDP02	3-1437590-4	GDP02S	1571668-1	GDP02STR	3-1437590-3	GDP02NTS	2	.238(6.04)	.100(2.54)
3-1437590-5	GDP04	3-1437590-7	GDP04S	—	—	3-1437590-6	GDP04NTS	4	.438(11.12)	.300(7.62)
3-1437590-8	GDP06	3-1437590-9	GDP06S	—	—	—	—	6	.638(16.20)	.500(12.7)
4-1437590-0	GDP08	4-1437590-1	GDP08S	4-1437590-2	GDP08STR	—	—	8	.838(21.28)	.700(17.78)
4-1437590-3	GDP10	4-1437590-4	GDP10S	4-1437590-5	GDP10STR	—	—	10	1.038(26.36)	.900(22.86)

DIP Switches, Flush Rocker Actuator, Through Hole and Surface Mount

GDB

Flush Rocker Actuator



GDB08

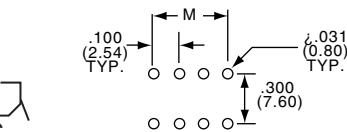
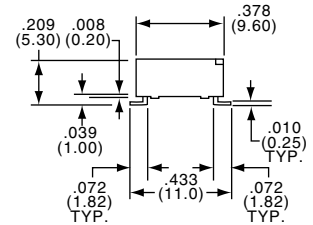
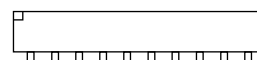
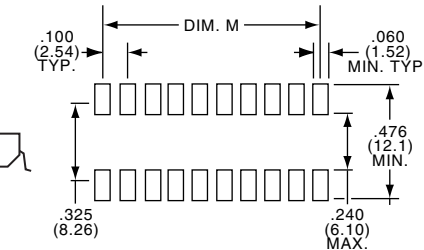
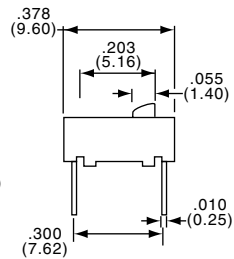
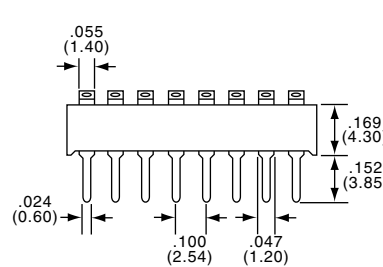
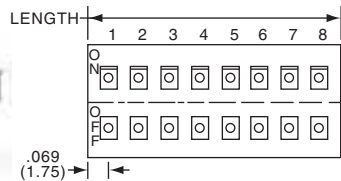
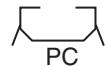

Part Number								Poles	Length	Dim. M
PC Model		S Model								
Tyco Electronics	Alcoswitch	Tyco Electronics	Alcoswitch							
1437590-1	GDB02	—	GDB02S					2	.238(6.04)	.100(2.54)
1437590-2	GDB04	1437590-3	GDB04S					4	.438(11.12)	.300(7.62)
1437590-4	GDB06	1437590-5	GDB06S					6	.638(16.20)	.500(12.7)
1437590-6	GDB08	1437590-7	GDB08S					8	.838(21.28)	.700(17.78)
1437590-8	GDB10	1437590-9	GDB10S					10	1.038(26.36)	.900(22.86)

DIP Switches, Recessed Rocker, Through Hole and Surface Mount

SEE PAGE A3 FOR PRODUCT SPECIFICATIONS

Part Number				Poles	Length	Dim. M
PC Model		S Model				
Tyco Electronics	Alcoswitch	Tyco Electronics	Alcoswitch			
4-1437590-6	GDR02	4-1437590-7	GDR02S	2	.238(6.04)	.100(2.54)
4-1437590-8	GDR04	4-1437590-9	GDR04S	4	.438(11.12)	.300(7.62)
5-1437590-0	GDR06	5-1437590-1	GDR06S	6	.638(16.20)	.500(12.7)
5-1437590-2	GDR08	5-1437590-3	GDR08S	8	.838(21.28)	.700(17.78)
5-1437590-4	GDR10	—	GDR10S	10	1.038(26.36)	.900(22.86)

GDR
Classic Profile
Recessed Rocker Actuator



GDR08

A
GD Series

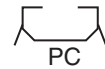
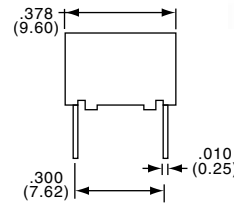
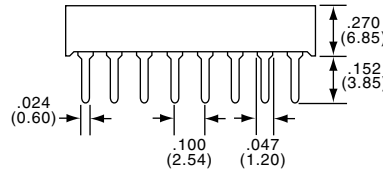
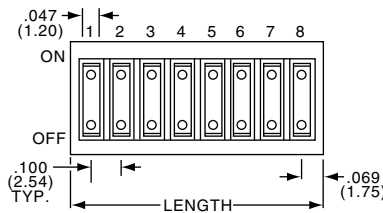

S

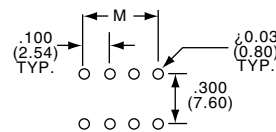
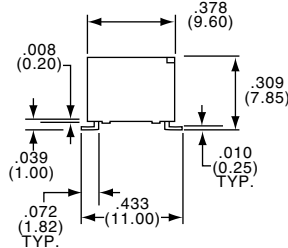
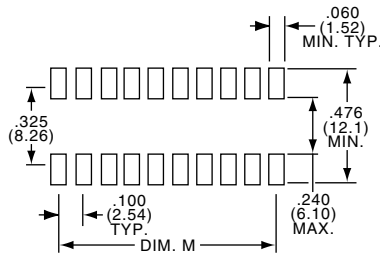

DIP Switches, Half Pitch, Low Profile

GDH
Half Pitch .050" Terminal Spacing

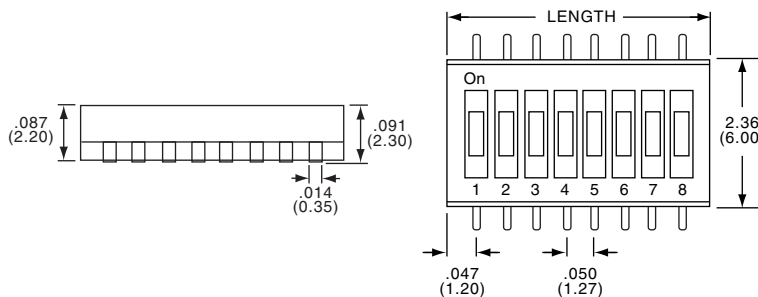

GDH08S

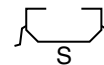
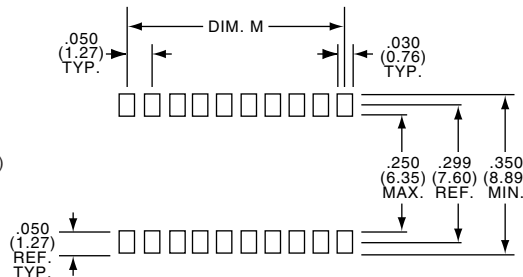
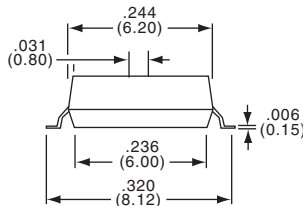

Part Number				Poles	Length	Dim. M
PC Model		S Model				
Tyco Electronics	Alcoswitch	Tyco Electronics	Alcoswitch			
1-1437590-0	GDH02S	1-1437590-3	GDH02STR	2	.144(3.66)	.050(1.27)
1-1437590-4	GDH04S	1-1437590-6	GDH04STR	4	.244(6.20)	.150(3.81)
1-1437590-9	GDH06S	2-1437590-1	GDH06STR	6	.344(8.75)	.250(6.35)
2-1437590-2	GDH08S	2-1437590-4	GDH08STR	8	.444(11.29)	.350(8.89)
2-1437590-6	GDH10S	2-1437590-8	GDH10STR	10	.544(13.82)	.450(11.43)

DIP Switches, Half Pitch, Ultra Low Profile, .067" High

MATERIAL SPECIFICATIONS:

ContactsCopper alloy, gold plate over nickel
 Case MaterialHigh temperature polyamide, UL 94V-0
 Actuator MaterialHigh temperature polyester, 94V-0
 Moving ContactCopper alloy, gold plate over nickel
 Fixed ContactCopper alloy, gold plate over nickel
 TerminalsCopper alloy, gold flash over nickel

TYPICAL PERFORMANCE CHARACTERISTICS:

Contact RatingNon-switching: 100 Milliamps @ 50 VDC
 Switching: 25 Milliamps @ 24 VDC
 Initial Contact Resistance100 Milliohms max.
 Insulation Resistance100 Megohms min. @ 100 VDC
 Dielectric Strength300 VAC, 1 minute
 Actuation Force60 - 600 Grams max.
 Life Expectancy1,000 Cycles min.

ENVIRONMENTAL SPECIFICATIONS:

Operating Temperature.....-30°C to +85°C (-22°F to +185°F)
 Storage Temperature.....-45°C to +100°C (-49°F to +212°F)

MGDH

Half Pitch .050" Terminal Spacing, .067" High



MGDH04

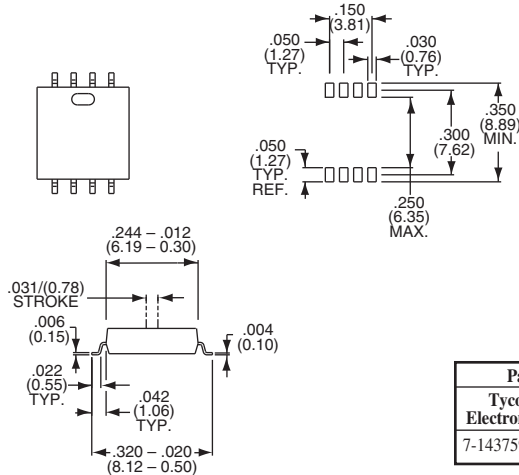
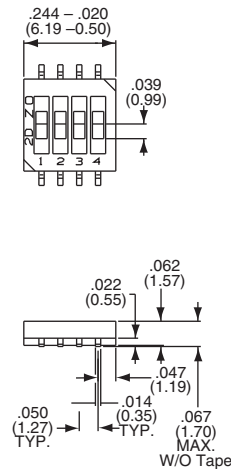

Part Number	
Tyco Electronics	Alcoswitch
7-1437590-5	MGDH04

DIP Switches, Extended Actuator, Auto Insertable, Through Hole and Surface Mount

FEATURES:

- Available in PC or surface mount termination.
- High pressure wiping contact allows aqueous or solvent cleaning without tape seal.
- Auto-insertable
- Tape Seal version available for vacuum pick-n-place
- Unique design can withstand vapor phase reflow or wave soldering conditions.
- Gas tight contacts
- Shipped in the off position

ENVIRONMENTAL SPECIFICATIONS:

Operating Temperature-30°C to + 85°C
 Storage Temperature-45°C to + 100°C
 Solder Heat Resistance.....245°C ± 5°C with switch in "off" position 30 seconds when mounted on a .060" thick PCB per MIL-STD202, Method 210
 Cleaning.....Aqueous solution or solvent

MATERIAL SPECIFICATIONS:

Base and CoverPPS-UL94V-0, (Black)
 Actuator.....PA6T-UL94V-0, (White)
 Fixed Contact/TerminalCopper alloy plate-solder/copper
 Moving ContactCopper alloy plate-gold/nickel

TYPICAL PERFORMANCE CHARACTERISTICS:

Contact Rating0.4 VA @ 20 VDC max.
 Max Rating Switching-100 Milliamp @ 24VDC
 Min Rating Switching-1 Microamp @ 1 Millivolt
 Max Rating Non Switching-1 Amp @ 5VDC
 Initial Contact Resistance50 Milliohms max.
 Insulation Resistance1,000 Megohms min. @ 100 VDC
 Dielectric Strength500 VAC
 Operating ForceLess than 800 grams
 Actuator TravelAD/R Series 1.30mm/.050" piano style 25°
 Life Expectancy1,000 Cycles



ADE

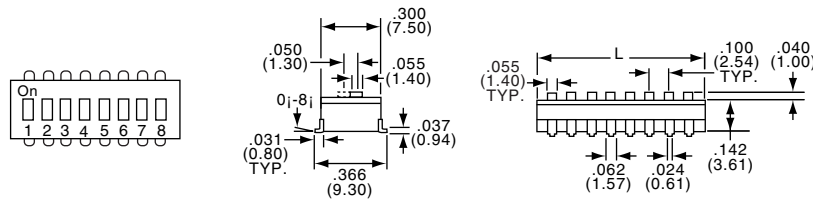

ADE08
Extended Actuator

S Termination Shown

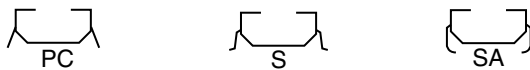

PC Term.		"S" Term.		"SA" Term.		No. of Positions	Actuator Style	Dim. L
Tyco Electronics	Alcoswitch	Tyco Electronics	Alcoswitch	Tyco Electronics	Alcoswitch			
1437586-2	ADE02	1437586-4	ADE02S	1437586-5	ADE02SA	2	Slide	.278(7.06)
1437586-7	ADE03	1437586-8	ADE03S	—	ADE03SA	3	Slide	.378(9.60)
1-1437586-0	ADE04	1-1437586-2	ADE04S	1-1437586-3	ADE04SA	4	Slide	.478(12.14)
1-1437586-5	ADE05	1-1437586-7	ADE05S	—	ADE05SA	5	Slide	.578(14.68)
1-1437586-8	ADE06	2-1437586-0	ADE06S	2-1437586-1	ADE06SA	6	Slide	.678(17.22)
2-1437586-3	ADE07	2-1437586-5	ADE07S	—	ADE07SA	7	Slide	.778(19.76)
2-1437586-6	ADE08	2-1437586-8	ADE08S	2-1437586-9	ADE08SA	8	Slide	.878(22.30)
3-1437586-0	ADE09	—	ADE09S	—	ADE09SA	9	Slide	.978(24.84)
3-1437586-2	ADE10	3-1437586-7	ADE10S	—	ADE10SA	10	Slide	1.078(27.38)
3-1437586-8	ADE12	1571337-1	ADE12S	—	ADE12SA	12	Slide	1.278(32.51)

See Page A9 for PC Pad Layout.

DIP Switches, Flush Acuator, Auto Insertable, Through Hole, and Surface Mount

SEE PAGE A7 FOR PRODUCT SPECIFICATIONS

ADF

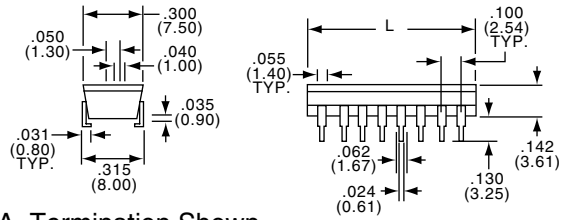
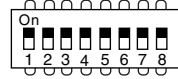

SA Termination Shown

See Page A9 for PC Pad Layout.

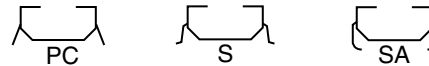

PC Term.		PC Term. w/Tape		No. of Positions	Actuator Style	Dim. L
Tyco Electronics	Alcoswitch	Tyco Electronics	Alcoswitch			
4-1437586-2	ADF02	5-1437586-0	ADF02T	2	Slide	.278(7.06)
5-1437586-1	ADF03	5-1437586-6	ADF03T	3	Slide	.378(9.60)
5-1437586-7	ADF04	6-1437586-4	ADF04T	4	Slide	.478(12.14)
6-1437586-5	ADF05	7-1437586-0	ADF05T	5	Slide	.578(14.68)
7-1437586-1	ADF06	8-1437586-0	ADF06T	6	Slide	.678(17.22)
8-1437586-1	ADF07	8-1437586-5	ADF07T	7	Slide	.778(19.76)
8-1437586-6	ADF08	9-1437586-5	ADF08T	8	Slide	.878(22.30)
9-1437586-6	ADF09	—	ADF09T	9	Slide	.978(24.84)
1437587-1	ADF10	1437587-7	ADF10T	10	Slide	1.078(27.38)
—	ADF12	1571336-1	ADF12T	12	Slide	1.278(32.51)

"S" Term.		"S" Term. w/Tape Seal		Tape & Reel		No. of Positions	Actuator Style	Dim. L
Tyco Electronics	Alcoswitch	Tyco Electronics	Alcoswitch	Tyco Electronics	Alcoswitch			
4-1437586-4	ADF02S	4-1437586-8	ADF02ST	4-1437586-9	ADF02STTR	2	Slide	.278(7.06)
5-1437586-2	ADF03S	5-1437586-4	ADF03ST	5-1437586-5	ADF03STTR	3	Slide	.378(9.60)
5-1437586-9	ADF04S	6-1437586-3	ADF04ST	1437583-6	ADF04STTR	4	Slide	.478(12.14)
6-1437586-6	ADF05S	6-1437586-8	ADF05ST	6-1437586-9	ADF05STTR	5	Slide	.578(14.68)
7-1437586-5	ADF06S	7-1437586-8	ADF06ST	7-1437586-9	ADF06STTR	6	Slide	.678(17.22)
8-1437586-2	ADF07S	8-1437586-3	ADF07ST	8-1437586-4	ADF07STTR	7	Slide	.778(19.76)
8-1437586-8	ADF08S	9-1437586-1	ADF08ST	9-1437586-2	ADF08STTR	8	Slide	.878(22.30)
9-1437586-7	ADF09S	9-1437586-8	ADF09ST	9-1437586-9	ADF09STTR	9	Slide	.978(24.84)
1437587-3	ADF10S	1437587-5	ADF10ST	1437587-6	ADF10STTR	10	Slide	1.078(27.38)
1437587-8	ADF12S	—	ADF12ST	1437587-9	ADF12STTR	12	Slide	1.278(32.51)

"SA" Term.		"SA" Term. w/Tape Seal		No. of Positions	Actuator Style	Dim. L
Tyco Electronics	Alcoswitch	Tyco Electronics	Alcoswitch			
4-1437586-5	ADF02SA	4-1437586-6	ADF02SAT	2	Slide	.278(7.06)
5-1437586-3	ADF03SA	—	ADF03SAT	3	Slide	.378(9.60)
6-1437586-0	ADF04SA	6-1437586-1	ADF04SAT	4	Slide	.478(12.14)
—	ADF05SA	—	ADF05SAT	5	Slide	.578(14.68)
7-1437586-6	ADF06SA	7-1437586-7	ADF06SAT	6	Slide	.678(17.22)
—	ADF07SA	—	ADF07SAT	7	Slide	.778(19.76)
8-1437586-9	ADF08SA	9-1437586-0	ADF08SAT	8	Slide	.878(22.30)
—	ADF09SA	—	ADF09SAT	9	Slide	.978(24.84)
—	ADF10SA	1437587-4	ADF10SAT	10	Slide	1.078(27.38)
—	ADF12SA	—	ADF12SAT	12	Slide	1.278(32.51)

DIP Switches, Piano Acuator, Auto Insertable, Through Hole, and Surface Mount

A
AD Series

ADP



ADP04S

Piano Actuator

"PC" Termination Shown

SEE PAGE A7 FOR PRODUCT SPECIFICATIONS

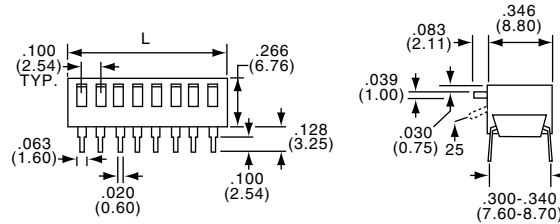

Lever Down "On"		"S" Term Lever Down "On"		"SA" Term. Lever Down "On"		No. of Positions	Actuator Style	Dim. L
Tyco Electronics	Alcoswitch	Tyco Electronics	Alcoswitch	Tyco Electronics	Alcoswitch			
1-1437587-1	ADP02	1-1437587-2	ADP02S	1-1437587-3	ADP02SA	2	Piano	.278(7.06)
1-1437587-5	ADP04	1-1437587-7	ADP04S	1-1437587-8	ADP04SA	4	Piano	.478(12.14)
2-1437587-0	ADP05	2-1437587-1	ADP05S	—	ADP05SA	5	Piano	.578(14.68)
2-1437587-2	ADP06	2-1437587-3	ADP06S	2-1437587-4	ADP06SA	6	Piano	.678(17.22)
2-1437587-5	ADP07	—	ADP07S	—	ADP07SA	7	Piano	.778(19.76)
2-1437587-6	ADP08	2-1437587-8	ADP08S	2-1437587-9	ADP08SA	8	Piano	.878(22.30)
3-1437587-0	ADP09	—	ADP09S	3-1437587-1	ADP09SA	9	Piano	.978(24.84)
3-1437587-3	ADP10	3-1437587-6	ADP10S	—	ADP10SA	10	Piano	1.078(27.38)

Lever Up "On"		"S" Term Lever Up "On"		"SA" Term. Lever Up "On"		No. of Positions	Actuator Style	Dim. L
Tyco Electronics	Alcoswitch	Tyco Electronics	Alcoswitch	Tyco Electronics	Alcoswitch			
4-1437587-7	ADPA02	—	ADPA02S	—	ADPA02SA	2	Piano	.278(7.06)
4-1437587-8	ADPA04	5-1437587-0	ADPA04S	5-1437587-1	ADPA04SA	4	Piano	.478(12.14)
5-1437587-2	ADPA05	5-1437587-3	ADPA05S	—	ADPA05SA	5	Piano	.578(14.68)
5-1437587-4	ADPA06	5-1437587-5	ADPA06S	5-1437587-6	ADPA06SA	6	Piano	.678(17.22)
5-1437587-7	ADPA07	—	ADPA07S	—	ADPA07SA	7	Piano	.778(19.76)
5-1437587-8	ADPA08	6-1437587-0	ADPA08S	—	ADPA08SA	8	Piano	.878(22.30)
—	ADPA09	—	ADPA09S	—	ADPA09SA	9	Piano	.978(24.84)
6-1437587-1	ADPA10	—	ADPA10S	—	ADPA10SA	10	Piano	1.078(27.38)

TERMINATION OPTIONS

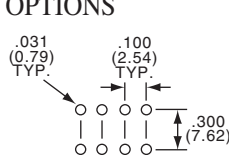

PC Termination

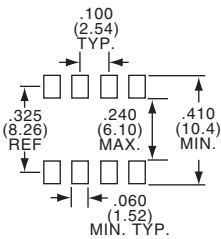

S Termination

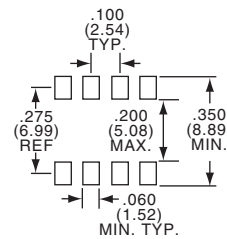
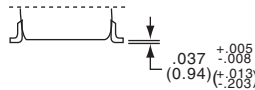

SA Termination

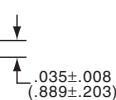

Hybrid DIP Switches, Through Hole and Surface Mount

A

AR Series

AUTO-INSERTABLE* DIP SWITCH WITH INTEGRAL RESISTORS

SEE PAGE A7 FOR PRODUCT SPECIFICATIONS

* Flush actuator versions are auto-insertable

FEATURES:

All the features of the AD SERIES - PLUS

- Thick film pull-up resistors molded into the base of the switch.
- Replaces discrete resistor network plus DIP Switch with one component.
- Available with 3.3K ohms or 10K ohms resistors.
- Ceramic substrate allows wave soldering temperatures of 245°C for up to 30 seconds per MIL-STD 202, Method 210.
- Custom resistor values available.
- Shipped in off position.

Rated Pwr.	Resistance	Tolerance	Max. Voltage
125 mW	3.3K Ohms (red)	±5% at 85°C	24V
125 mW	10K Ohms (green)	±5% at 85°C	24V

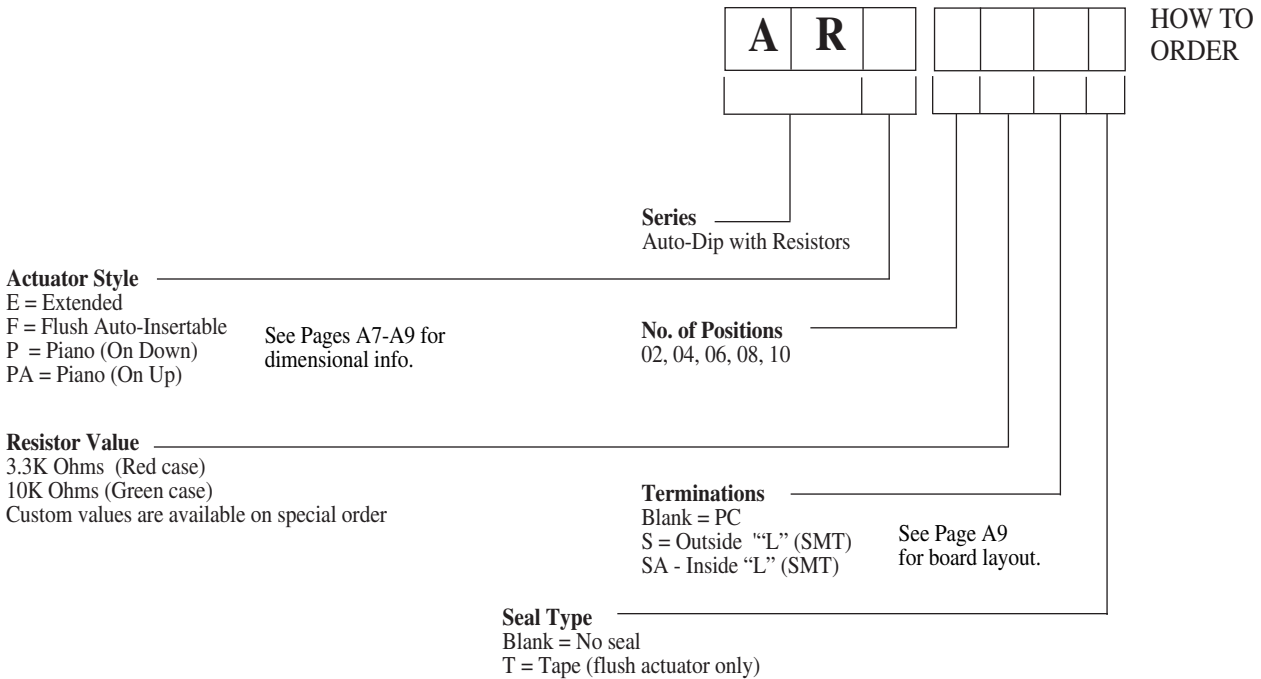
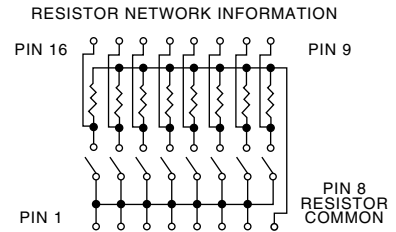

Example: ARF 06 10KST = Auto-Dip
 Flush actuator
 06 positions
 10K ohms resistors
 Outside "L" terminations & tape seal



Alcoswitch 7000 Series DIP switches are available in standard single pole, single throw; side actuated, single pole, single throw and multiple series versions. Contacts are made of high strength copper alloy with .000030 [0.00076] gold over .000050 [0.00127] nickel plating in contact area and legs plated to meet Tyco Electronics Solderability Specification 109-11-3.

The multiple series switches offer the unique feature of single pole switches coupled mechanically to provide switching of various poles simultaneously. This allows flexibility in programming.

Multipole switches are available with or without lever-actuated rockers and in a variety of configurations in addition to those listed. The maximum number of poles that can be ganged is six.

DIP Switches

Performance Characteristics

Current and Voltage Rating:

Nonswitching — 1.5 amperes max. at 50 VDC
 Switching — 100 milliamperes max at 5 VDC (resistive load);
 25 milliamperes max. at 24 VDC (resistive load)

Contact Resistance, Dry Circuit:

100 milliohms max. (end of life) and 50 milliohms (initial) at 50 mV open circuit, 50 milliamperes

Insulation Resistance:

1 x 10⁹ ohms min. at 100 VDC (initial)

Dielectric Withstanding Voltage:

500 VDC min. at standard atmospheric conditions

Capacitance:

5 picofarads max.

Temperature Rating:

Nonoperating — -73.3°C to +105°C
 Operating — -55°C to +105°C

Vibration:

Discontinuities shall not exceed 10 microseconds when subjected to 10-2000-10 Hz transversing for 20 minutes at .060 [1.52] inches total excursion

Shock:

No physical damage or discontinuities greater than 10 microseconds when tested with .10 ampere current applied per Tyco Electronics Specification 109-26, Condition A

Humidity:

Withstands an environment of +40°C and 95% RH for 96 hours

Durability:

No physical damage or contact resistance greater than 100 milliohms up to 7000 cycles of actuation with a resistive load of 24 VDC and 25 milliamperes max. current applied

Terminal Strength (Bend Test):

Two (2) 45° bend cycles per MIL-STD-202, Method 211, Condition B

Materials

Housing:

Glass-filled polyester, 94V-0 rated, black

Rocker:

Thermoplastic, 94V-0 rated, white

Spring Contacts and Leads:

Copper alloy with .000030 [0.00076] gold over .000050 [0.00127] nickel in contact area and .000150 [0.00381] tin-lead over .000050 [0.00127] nickel on solder legs, plated to meet Tyco Electronics Solderability Specification 109-11-3.

Technical Documents

Product Specification:

108-7519

Instruction Sheet:

408-07779

Application Specification:

114-1056

**Single Pole
Single Throw
Side Actuated
Low Profile**

Contact Lead Spacing —
.100 x .300 [2.54 x 7.62]
Lead Length — .140 [3.56]
below mounting surface

Contact Arrangement

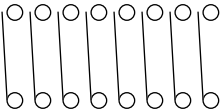

Pin 1

Note: Switches shown in open position

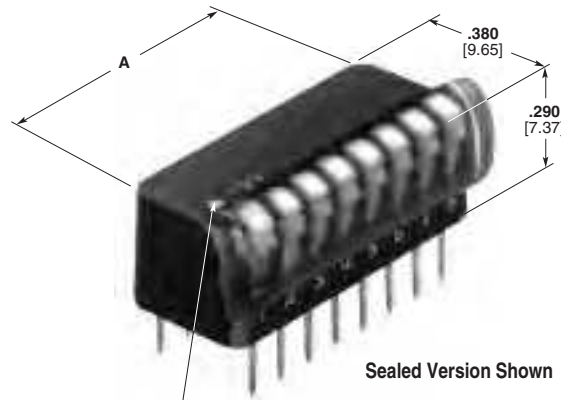

Sealed Version Shown

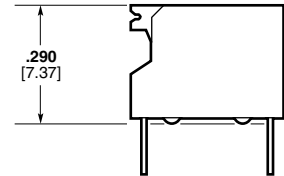

White Dot Identifies Pin 1

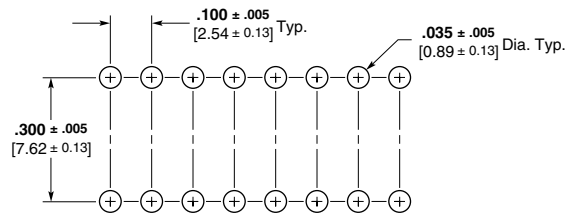

Recommended PC Board Hole Pattern

No. of Switches	Dim. A		SPST Side Actuated Part No.		
	inch	mm	Unsealed ¹	Sealed	Tape Sealed
2	.280	7.11	1-435802-0	—	—
3	.380	9.65	435802-2	—	—
4	.480	12.19	435802-3	1-435802-5	—
5	.580	14.73	435802-4	1-435802-6	—
6	.680	17.27	435802-5	1-435802-7	—
7	.780	19.81	435802-6	1-435802-8	—
8	.880	22.35	435802-1	435802-9	3-435802-8
9	.980	24.89	435802-7	1-435802-9	—
10	1.080	27.43	435802-8	2-435802-0	—
11	1.180	29.97	—	2-435802-1	—
12	1.280	32.51	—	2-435802-2	—

¹ All switches are bottom sealed.

DIP Switches, Extended Actuator, Single or Double Pole, Double Throw

Multiple Single Pole Double Throw

Contact Lead Spacing —
.100 x .300 [2.54 x 7.62]
Lead Length — .140 [3.56]
below mounting surface

Contact Arrangement

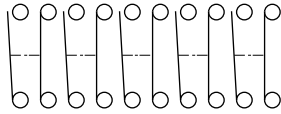

Pin 1

Note: Switch positions are closed when rockers are down toward white dots. Switches have make-before-break circuit design.

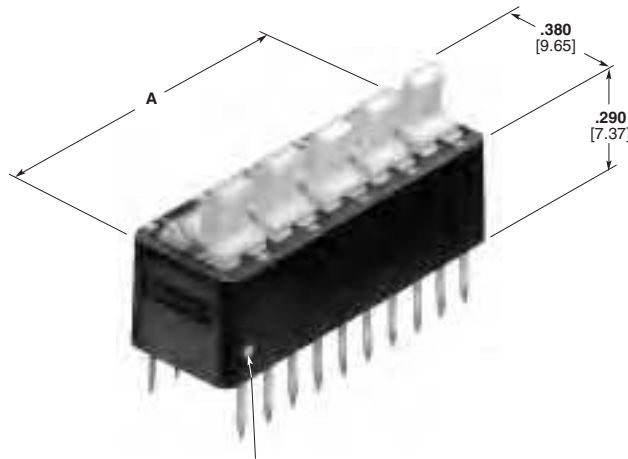

White Dot Identifies Pin 1

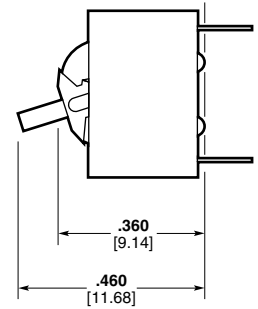

Extended Lever Actuator Shown

No. of Switches	Dim. A		SPDT Part No.	
	inch	mm	Low Profile Actuator	Extended Lever Actuator
1	.280	7.11	435470-7	2-435470-1
2	.480	12.19	435470-1	2-435470-2
3	.680	17.27	435470-2	—
4	.880	22.35	435470-3	2-435470-4
5	1.080	27.43	—	2-435470-5
6	1.280	32.51	—	2-435470-6

Double Pole Double Throw

Contact Lead Spacing —
.100 x .300 [2.54 x 7.62]
Lead Length — .140 [3.56]
below mounting surface

Contact Arrangement

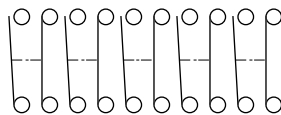

Pin 1

Note: Switch positions are closed when rockers are down toward white dots. Switches have make-before-break circuit design.

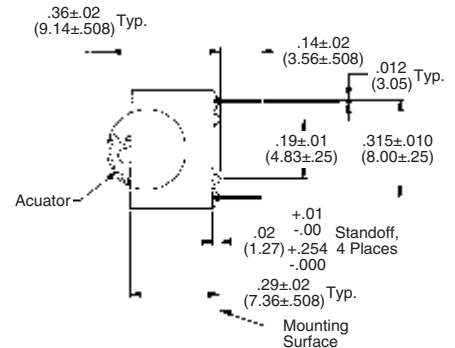
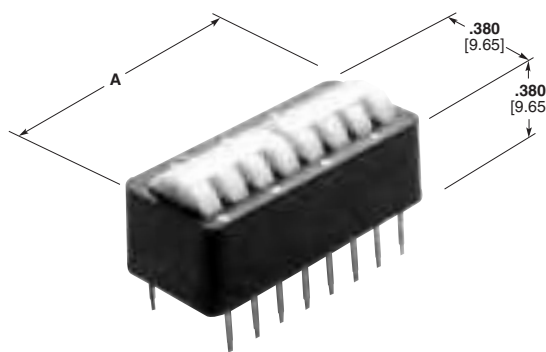

Low Profile Lever Actuator Shown

No. of Switches	Dim. A		DPDT Part No.	
	inch	mm	Low Profile Actuator	Extended Lever Actuator
1	.480	12.19	435470-5	3-435470-1
2	.880	22.35	435470-9	—

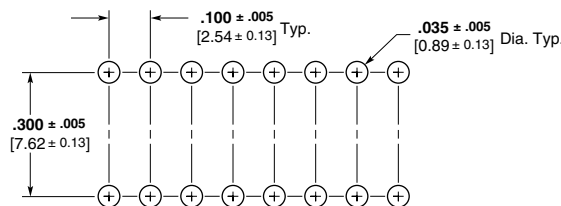

Recommended PC Board Hole Pattern

DIP Switches, Extended Actuator, Multiple Pole, Single Throw

Multiple Double Pole Single Throw

Contact Lead Spacing —
 .100 x .300 [2.54 x 7.62]
Lead Length — .140 [3.56]
 below mounting surface

Contact Arrangement

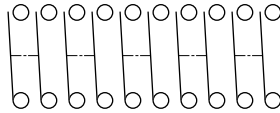

Pin 1

Note: Switches shown in open position.

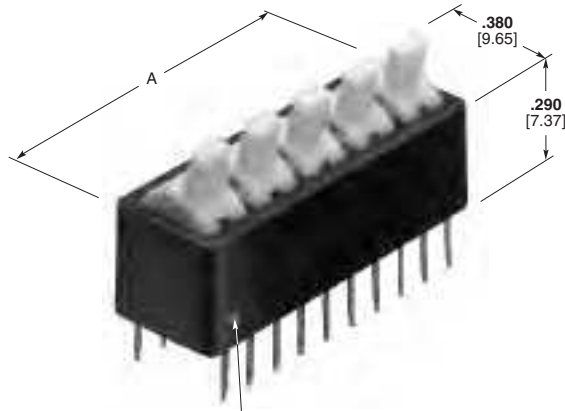

White Dot Identifies Pin 1

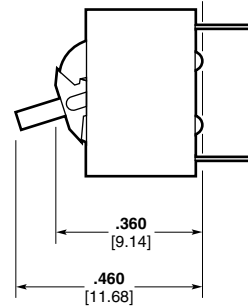

Extended Lever Actuator Shown

No. of Switches	Dim. A		DPST Part No.	
	inch	mm	Low Profile Actuator	Extended Lever Actuator
1	.280	7.11	435469-9	2-435469-1
2	.480	12.19	—	2-435469-2
4	.880	22.35	435469-3	2-435469-4
5	1.080	27.43	—	2-435469-5
6	1.280	32.51	—	2-435469-6

4-Pole Single Throw

Contact Lead Spacing —
 .100 x .300 [2.54 x 7.62]
Lead Length — .140 [3.56]
 below mounting surface

Contact Arrangement

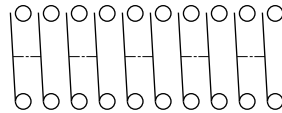

Pin 1

Note: Switches shown in open position.

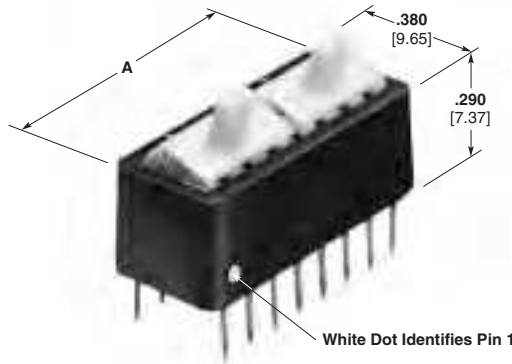

White Dot Identifies Pin 1

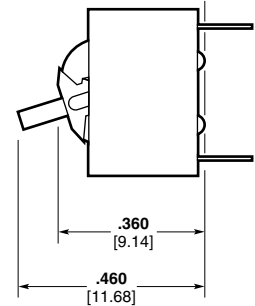

Extended Lever Actuator Shown

No. of Switches	Dim. A		4PST Part No.	
	inch	mm	Low Profile Actuator	Extended Lever Actuator
1	.480	12.19	435469-7	3-435469-1

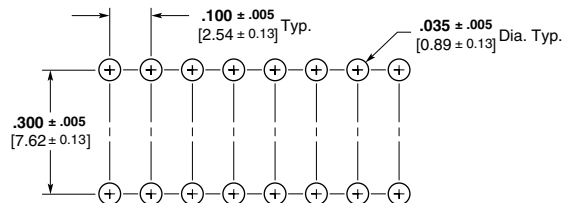

Recommended PC Board Hole Pattern

DIP Switches, Rocker Style Actuator

Contact Lead Spacing —
.100 x .300 [2.54 x 7.62]
Lead Length — .140 [3.56]
below mounting surface

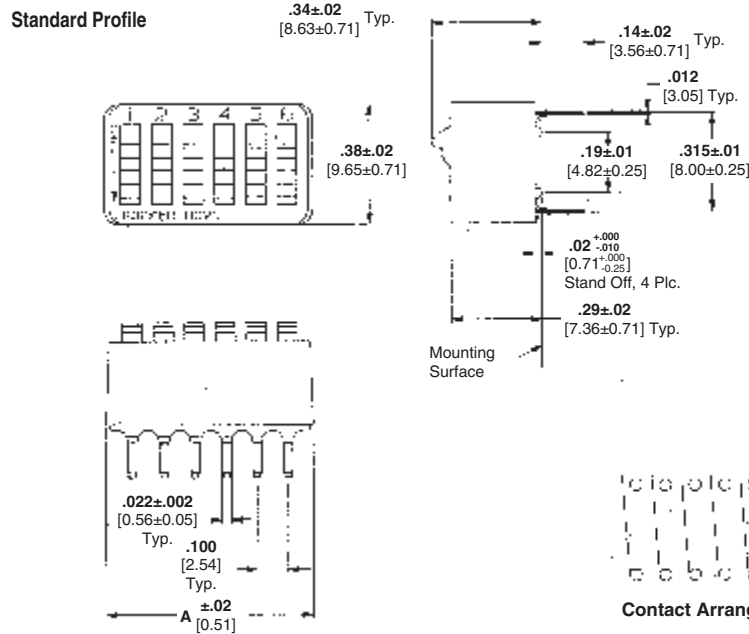
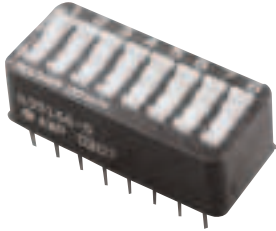

Contact Lead Spacing —
.100 x .300 [2.54 x 7.62]
Lead Length — .140 [3.56]
below mounting surface

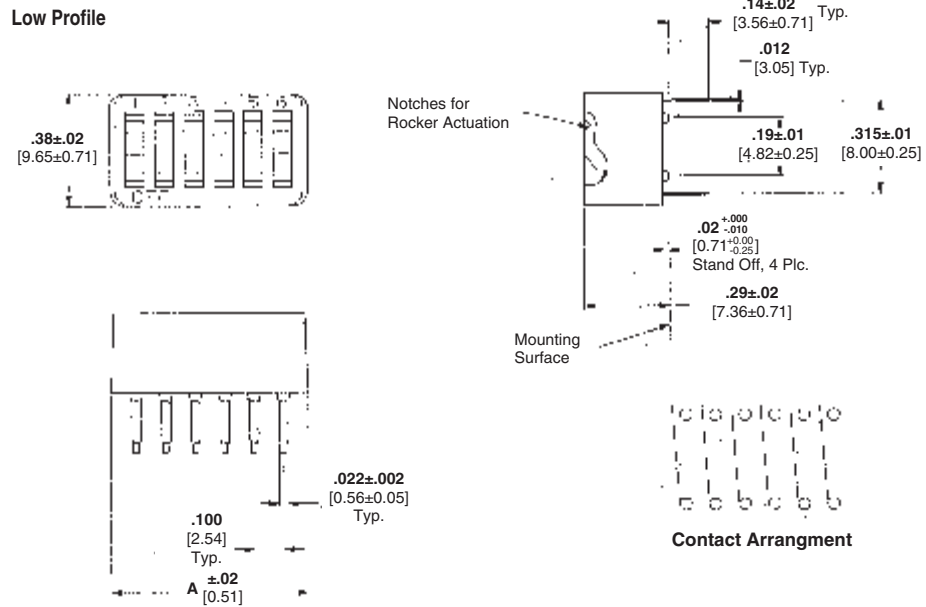

Number of Switches	SPST Standard Profile		SPST Low Profile	
	Unsealed	Sealed	Unsealed	Tape Sealed
2	2-435166-9	—	—	3-435626-6
3	—	—	—	3-435626-7
4	435166-2	4-435166-9	435626-1	3-435626-8
5	—	5-435166-0	435626-2	—
6	435166-4	5-435166-1	—	4-435626-0
7	435166-1	5-435166-2	—	4-435626-1
8	435166-5	5-435166-3	435626-5	4-435626-2
9	435166-6	—	—	—
10	435166-7	5-435166-5	—	4-435626-4

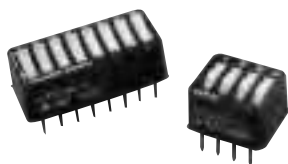

Alcoswitch 7100 Series DIP Switches are recommended for programming applications where the number of cycles per pole is limited. These single pole, single throw switches have been designed for a life of up to 2000 cycles per pole and feature contacts of copper alloy with .000030 [0.00076] gold over nickel plating in the contact area and legs plated to meet Tyco Electronics Solderability Specification 109-11-3. In addition, the SPST standard and low profile switches are also available with a top seal to provide protection during soldering and cleaning processes.

DIP Switches

Performance Characteristics

Current and Voltage Rating:

Nonswitching — 1.0 amperes max. at 40 VDC
 Switching — 60 milliamperes max at 5 VDC (resistive load);
 15 milliamperes max. at 24 VDC (resistive load)

Contact Resistance, Dry Circuit:

100 milliohms max. (end of life) and 50 milliohms (initial) at 50 mV open circuit, 50 milliamperes

Insulation Resistance:

1×10^9 ohms min. at 100 VDC (initial)

Dielectric Withstanding Voltage:

500 VDC min. at standard atmospheric conditions

Capacitance:

5 picofarads max.

Temperature Rating:

Nonoperating — -73°C to +105°C
 Operating — -55°C to +105°C

Vibration:

Discontinuities shall not exceed 10 microseconds when subjected to 10-2000-10 Hz transversing for 20 minutes at .060 [1.52] inches total excursion

Shock:

No physical damage or discontinuities greater than 10 microseconds when tested with .10 ampere current applied per Tyco Electronics Specification 109-26, Condition A

Humidity:

Withstands an environment of +40°C and 95% RH for 96 hours

Durability:

No physical damage or contact resistance greater than 100 milliohms after 2000 cycles of actuation with a resistive load of 24 VDC and 25 milliamperes max. current applied

Terminal Strength (Bend Test):

Two (2) 45° bend cycles per MIL-STD-202, Method 211, Condition B

Materials

Housing:

Glass-filled polyester, 94V-0 rated, blue

Rocker:

Thermoplastic, 94V-0 rated, white

Spring Contacts and Leads:

Copper alloy with .000030 [0.00076] gold over .000050 [0.00127] nickel in contact area and .000150 [0.00381] tin-lead over .000050 [0.00127] nickel on solder legs, plated to meet Tyco Electronics Solderability Specification 109-11-3.

Technical Documents

Product Specification:

108-7532

Instruction Sheet:

408-07779

Application Specification:

114-1056

DIP Switches, Rocker Style Actuator

**Single Pole
Single Throw**

Contact Lead Spacing —
.100 x .300 [2.54 x 7.62]
Lead Length — .140 [3.56]
below mounting surface

Contact Arrangement

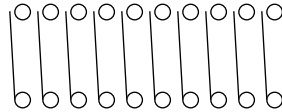

Pin 1

Note: Switches shown in open position.

**Single Pole
Single Throw
Low Profile**

Contact Lead Spacing —
.100 x .300 [2.54 x 7.62]
Lead Length — .140 [3.56]
below mounting surface

Contact Arrangement

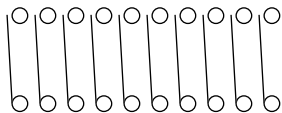

Pin 1

Note: Switches shown in open position.

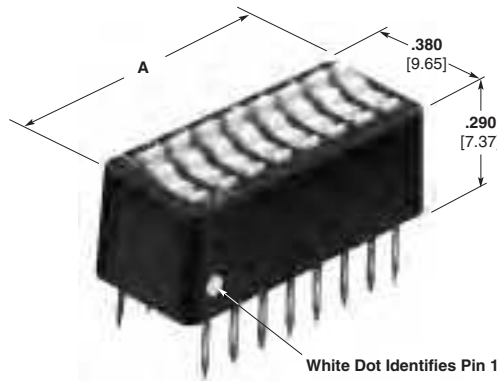

White Dot Identifies Pin 1

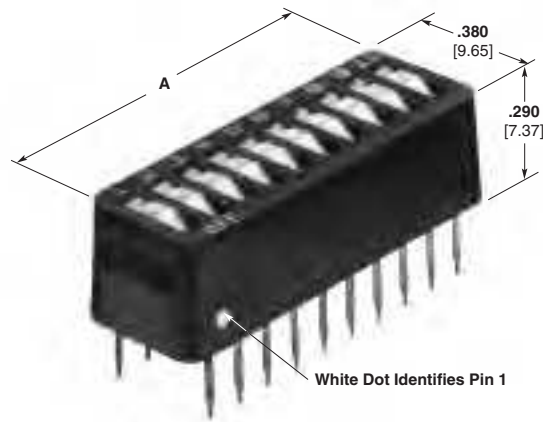
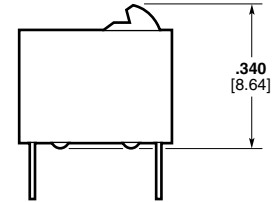

White Dot Identifies Pin 1

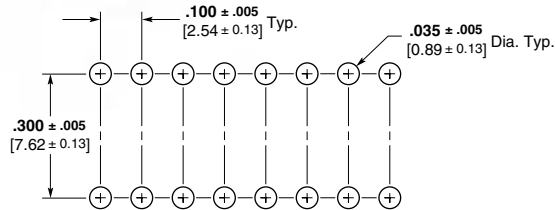
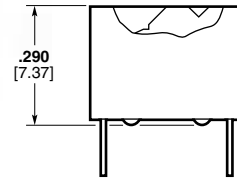

Recommended PC Board Hole Pattern

No. of Switches	Dim. A		SPST Standard Profile		SPST Low Profile	
	inch	mm	Unsealed ¹ Part No.	Sealed Part No.	Unsealed ¹ Part No.	Tape Sealed Part No.
2	.280	7.11	2-435640-9	—	435668-1	2-435668-6
3	.380	9.65	3-435640-0	—	—	3-435668-3
4	.480	12.19	435640-2	3-435640-5	435668-3	3-435668-4
5	.580	14.73	435640-3	3-435640-6	435668-4	3-435668-5
6	.680	17.27	435640-4	3-435640-7	435668-5	2-435668-5
7	.780	19.81	435640-1	3-435640-8	—	2-435668-7
8	.880	22.35	435640-5	3-435640-9	435668-7	2-435668-8
9	.980	24.89	435640-6	4-435640-0	—	2-435668-9
10	1.080	27.43	435640-7	4-435640-1	435668-9	3-435668-0
11	1.180	29.97	—	—	—	3-435668-1
12	1.280	32.51	3-435640-2	4-435640-3	—	3-435668-2

¹ All switches are bottom sealed.

Sip Switches, Low Profile, Vertical and Right Angle

FEATURES:

- End-to-end stackable in .100" center (SSV/SLV) versions
- High pressure wiping contacts allows aqueous or solvent cleaning
- Gas tight contacts (280,000 PSI)
- Ceramic substrate allows wave soldering temperature of 245° for up to 10 seconds (SLV Version)
- 2 SIP switches take up less board space than 1 DIP switch

ENVIRONMENTAL SPECIFICATIONS:

Operating Temperature-30°C to +85°C
 Storage Temperature-45°C to +100°C
 Solder Heat ResistanceWave soldering temperatures of 245°C ± 5°C with switch in off position 30 seconds when mounting on a .060" thick PCB per MIL-STD 202, Method 210

MATERIAL SPECIFICATIONS:

BasePPS 94V-0/Encapsulated Ceramic (SLV/SLH)
 CoverPBT 94V-0
 ContactsGold flashed Beryllium copper
 Actuator MaterialPolyamide
 Terminals/Fixed ContactsSolder coated copper alloy
 Terminal SealInsert molded
 Process SealGas tight contacts

TYPICAL PERFORMANCE CHARACTERISTICS:

Contact Rating0.4 VA @ 20 VDC max.
 Initial Contact Resistance50 Milliohms max.
 Insulation Resistance100 Megohms min. @ 100 VDC
 Dielectric Strength500 VAC
 Actuation Force800 Grams max.
 Actuator Travel50°
 Life Expectancy1,000 Cycles

SSV



SSV08

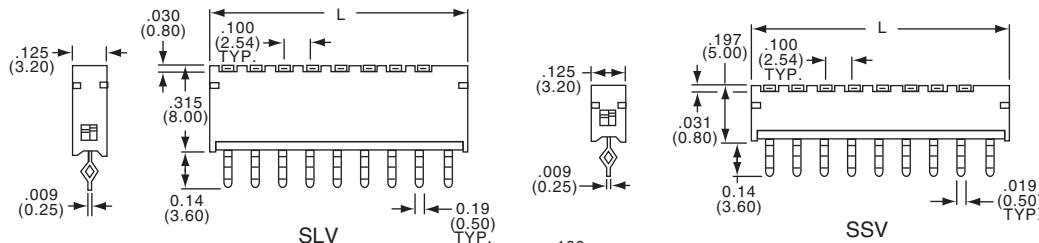

SLV



SLV08

Model		No. of Positions	Dim. L
Tyco Electronics	Alcoswitch		
2-1437589-2	SSV02	2	0.298
2-1437589-3	SSV04	4	0.498
2-1437589-4	SSV06	6	0.698
2-1437589-6	SSV08	8	0.898
2-1437589-7	SSV10	10	1.098
1-1437589-5	SLV04	4	0.498
1-1437589-6	SLV08	8	0.898

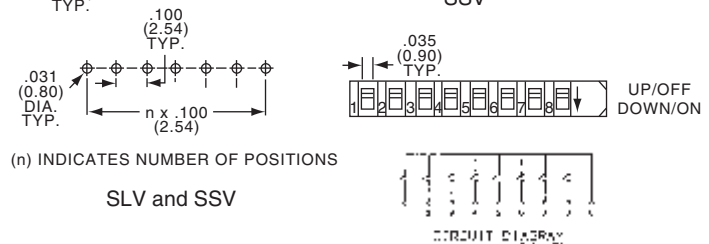

SSH



SSH06

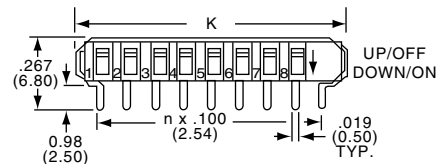
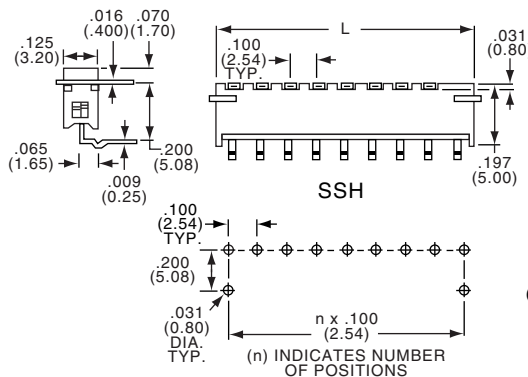

SSH

Model		No. of Positions	Dim. L	Dim. K
Tyco Electronics	Alcoswitch			
1-1437589-7	SSH02	2	0.298	0.338
1-1437589-8	SSH04	4	0.498	0.538
1-1437589-9	SSH06	6	0.699	0.738
2-1437589-0	SSH08	8	0.898	0.938
2-1437589-1	SSH10	10	1.098	1.138

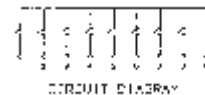

Alcoswitch DIP Shunts are a highly reliable, low cost means of manually programming various types of electrical/electronic equipment. The shunt consists of a series of conductive straps packaged in a DIP configuration. The straps can be retained intact for a closed circuit or broken with a hand tool to produce an open circuit.

DIP shunts are available in 4- through 12-position configurations. All shunts can be supplied either unprogrammed or preprogrammed.

DIP Shunts

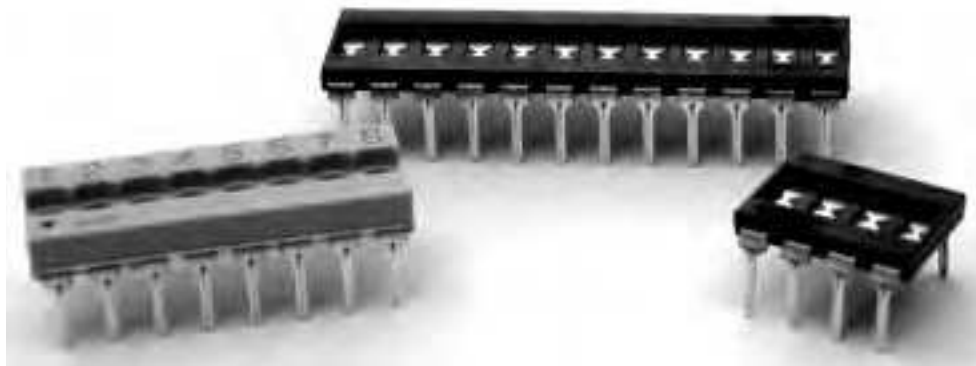

Performance Characteristics

Current Rating:

Standard Pressure — 2 amperes for +20°C rise above ambient (one conductor per shunt)
Machine Insertable — 1 ampere for +20°C rise above ambient (one conductor per shunt)

Insulation Resistance:

1 x 10¹⁰ ohms min. at 100 VDC

Dielectric Withstanding Voltage:

500 VDC min.

Capacitance:

2 picofarads max. between adjacent straps
5 picofarads max. across cut straps

Temperature Rating:

-55°C to +105°C

Humidity:

Withstands an environment of +40°C and 95% RH for 96 hours

Terminal Strength (Bend Test):

Two 45° bend cycles per MIL-STD-202, Method 211, Condition B
Resistance to Soldering Heat: EIA-364-56A Condition C

Reconnection Option

Cut straps can be reconnected by soldering bridging. Solder bridging recommendations are:

- Use low temperature solder
- Use solder tip approximately 1/32 [0.79] in diameter
- Do not let solder tip come in contact with plastic material

Materials

Housing:

Glass-filled thermoplastic, 94V-0 rated

Metal Parts:

Copper alloy with electroplated tin finish (gold plated I/O legs are optional)

Technical Documents

Product Specifications:

108-7533 Through Hole

Instruction Sheets:

408-07768 Through Hole

Application Specifications:

114-1054 Through Hole

**Standard Shunt
Standard Pressure**

Contact Lead Spacing —
.100 x .300 [2.54 x 7.62]
Lead Length — .140 [3.56]
below mounting surface
Housing Color — Black
Programming Tool — See below

**Programming
Hand Tool
Part No. 435862-1**

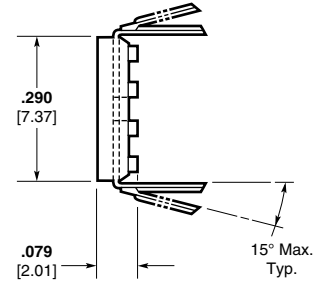
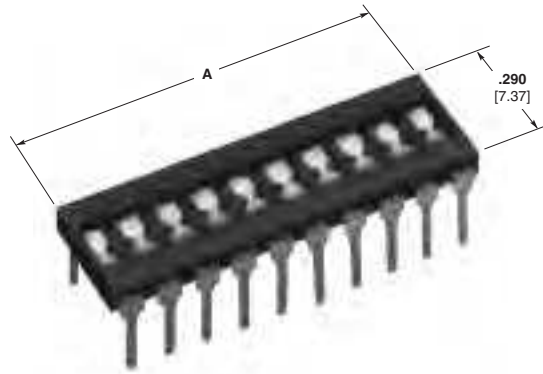

This tool provides a reliable means of programming DIP shunts. It is rugged, lightweight and dependable. No special skills are required to use this tool.

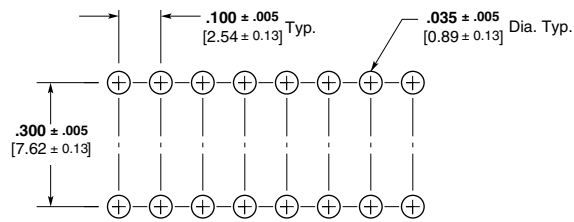

Recommended PC Board Hole Pattern

Machine Insertable Shunt
(Compatible with commercially available IC insertion equipment)

Contact Lead Spacing —
.100 x .300 [2.54 x 7.62]
Lead Length — .140 [3.56]
below mounting surface
Housing Color — Gray
Programming Tool — None required
(5 to 10 lbs. [22.2 to 44.4 N] required to manually program each shunt position)

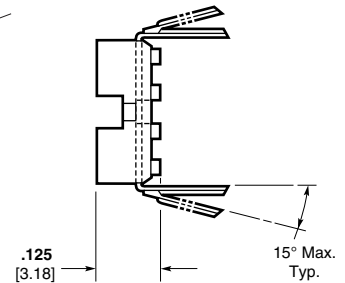
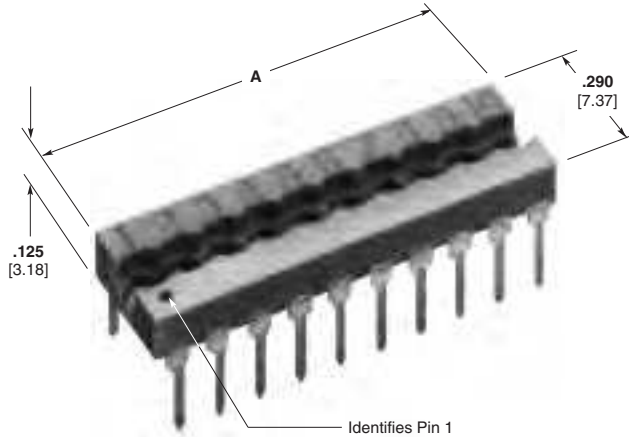

No. of Positions	Dim. A		Standard Shunt Standard Pressure	Machine Insertable Shunt
	inch	mm		
4	.400	10.16	435704-4	—
6	.600	15.24	435704-6	—
7	.700	17.78	435704-7	—
8	.800	20.32	435704-8	436860-7
9	.900	22.86	435704-9	—
10	1.000	25.40	1-435704-0	—
12	1.200	30.48	1-435704-2	—

Rotary DIP Switches, Low Profile, Process Sealed, 7MM, Through Hole and Surface Mount

FEATURES:

- 40% PCB area space savings over standard rotary dips
- 50% Lower in profile than standard rotary dips
- Hexadecimal or binary code, complement available
- Deflection temperature of 250°C for SMT reflow soldering
- Gold contacts, tin/lead terminals
- Sealed "O" ring design

MATERIAL SPECIFICATIONS:

Fixed Contacts/Terminals.....Brass, gold plated / tin/lead
 Moving Contacts.....BeCu, gold plated
 Case MaterialPPS UL94V-0
 RotorNylon UL94V-0
 Cover MaterialPPS UL94V-0
 O-RingFluoro Rubber

ENVIRONMENTAL SPECIFICATIONS:

Operating Temperature.....-10°C to +85°C
 Storage Temperature.....-45°C to +100°C
 Solder Heat ResistanceMIL-STD 202F, Method 210
 IR Process CapabilityEIA-364-56 Level II (250°C peak)

TYPICAL PERFORMANCE CHARACTERISTICS:

Contact Rating0.4 VA Max. @ 20 VDC
 Initial Contact Resistance50m Max. @ 2 VDC 10mA
 Insulation Resistance1,000 Megohms max.
 Dielectric Strength300 VAC for 1 minute
 Actuator Travel.....36° 10 Position, 22.5° 16 position
 Operating Force200 Grams avg.
 Life Expectancy20,000 Steps, mechanical

P.C. MOUNT

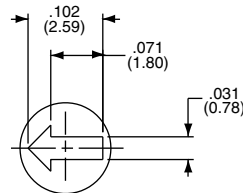
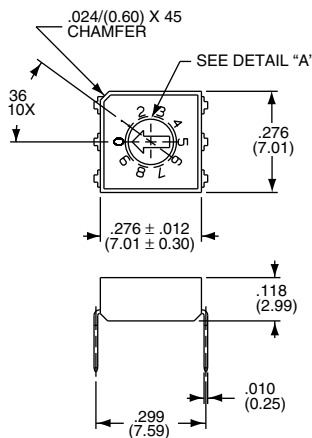

DETAIL "A"
SCALE 8:1

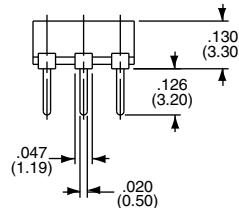

MRD10

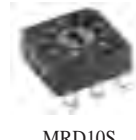

MRD10S



MRD16C



MRD16S

SURFACE MOUNT

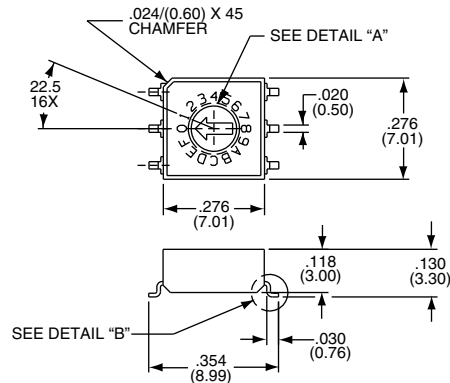

DETAIL "B"
SCALE 8:1

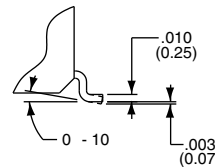

Rotary DIP Switches, Low Profile, Process Sealed, 7MM, Through Hole and Surface Mount

TERMINAL IDENTIFICATION
VIEWED FROM BOTTOM SWITCH

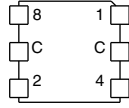

P.C. LAYOUT (THRU HOLE)

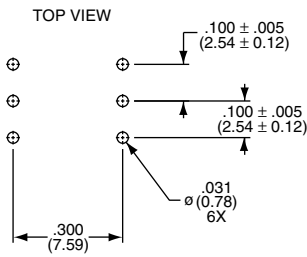

P.C. LAYOUT (SURFACE MOUNT)

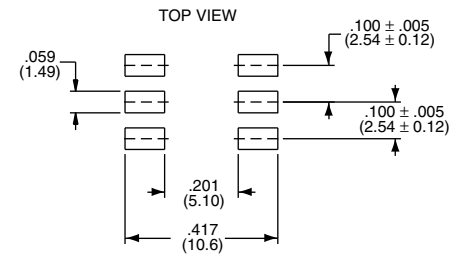

TRUTH TABLES

10-Position, BCD (red actuator)

Pos.	0	1	2	3	4	5	6	7	8	9
C	X	X	X	X	X	X	X	X	X	X
1		X		X		X		X		X
2			X	X			X	X		
4					X	X	X	X		
8									X	X

16-Position, Hexadecimal (green actuator)

Pos.	0	1	2	3	4	5	6	7	8	9	A	B	C	D	E	F
C	X	X	X	X	X	X	X	X	X	X	X	X	X	X	X	X
1		X		X		X		X		X		X		X		X
2			X	X			X	X			X	X			X	X
4					X	X	X	X					X	X	X	X
8									X	X	X	X	X	X	X	X

10-Position, BCD Complement (orange actuator)

Pos.	0	1	2	3	4	5	6	7	8	9
C	X	X	X	X	X	X	X	X	X	X
1	X		X		X		X		X	
2	X	X			X	X			X	X
4	X	X	X	X					X	X
8	X	X	X	X	X	X	X	X		

16-Position Hexadecimal Complement (white actuator)

Pos.	0	1	2	3	4	5	6	7	8	9	A	B	C	D	E	F
C	X	X	X	X	X	X	X	X	X	X	X	X	X	X	X	X
1	X		X		X		X		X		X		X		X	
2	X	X			X	X			X	X			X	X		
4	X	X	X	X					X	X	X	X				
8	X	X	X	X	X	X	X	X								

HOW TO ORDER

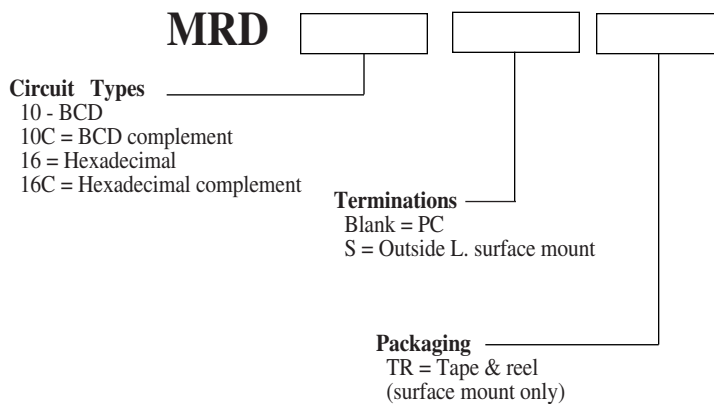

Color Code	
Circuit Type	Actuator Color
10	Red
10C	Orange
16	Green
16C	White

Rotary Dip Switches, Process Sealed, Through Hole and Surface Mount

MATERIAL SPECIFICATIONS:

- ContactsGold flashed copper alloy
- TerminalsTin lead plated brass
- Base, Rotor, CasePC, Glass filled PBT resin (blue case)
SMT, Polyimide (white case)
- Movable Contact.....Gold flashed copper alloy
- Ball Support Plate.....Copper alloy
- Detent SpringStainless steel (spring)

TYPICAL PERFORMANCE CHARACTERISTICS:

- Contact Rating0.4 VA @ 20 VDC max.
- Initial Contact Resistance50 Milliohms max. @ 2 VDC
- Insulation Resistance1,000 Megohms min. @ 100 VDC
- Dielectric Strength300 VAC RMS @ sea level
- Operating Force6 Oz.-in. nom.
- SMT Operating Force.....3 Oz.-in. nom.
- Life Expectancy20,000 Steps

ENVIRONMENTAL SPECIFICATIONS:

- Operating Temperature.....-22°F to +185°F (-30°C to +85°C)
- Storage Temperature.....-49°F to 212°F (-45°C to +100°C)
- Vibration Resistance.....Subjected to vibration of 10-55hz per second with a total amplitude of .06 in. in 3 mutually perpendicular directions for 2 hours each
- Shock ResistanceWill withstand 50G acceleration in 3 different planes for a period of 11 milliseconds
- Salt Spray TestWithstands an atmosphere of 5% salt water at temperature of 50°C
- Hydrogen Sulfide TestWithstands an atmosphere of 15-20 PPM hydrogen sulfide gas at temperature of 40°C for 240 hours
- Atmospheric TestWithstands an atmosphere of 30-50 PPM sulfite gas at a temperature of 40°C for 240 hours
- Solder Heat Resistance.....Withstands 5 sec. flow solder bath of 260°C when mounted on a .06" thick PC board per MIL-STD 202, Method 210
- Bubble Test.....Withstands submersion in 60°C Flouiert for 1 min. without leakage



DRD10E



DRD16CE

TRUTH TABLES

Terminal Identification
(view from bottom of the switch)

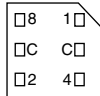

VIEW FROM BOTTOM
OF THE SWITCH

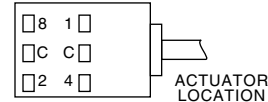

NOTE: COMMON TERMINALS ARE CONNECTED INTERNALLY.

Pos.	0	1	2	3	4	5	6	7	8	9
C	X	X	X	X	X	X	X	X	X	X
1		X		X		X		X		X
2			X	X			X	X		
4					X	X	X	X		
8									X	X

Pos.	0	1	2	3	4	5	6	7	8	9	A	B	C	D	E	F
C	X	X	X	X	X	X	X	X	X	X	X	X	X	X	X	X
1		X		X		X		X		X		X		X		X
2			X	X			X	X			X	X			X	X
4					X	X	X	X					X	X	X	X
8									X	X	X	X	X	X	X	X

Pos.	0	1	2	3	4	5	6	7	8	9
C	X	X	X	X	X	X	X	X	X	X
1	X		X		X		X		X	
2	X	X			X	X			X	X
4	X	X	X	X					X	X
8	X	X	X	X	X	X	X	X		

Pos.	0	1	2	3	4	5	6	7	8	9	A	B	C	D	E	F
C	X	X	X	X	X	X	X	X	X	X	X	X	X	X	X	X
1	X		X		X		X		X		X		X		X	
2	X	X			X	X			X	X			X	X		
4	X	X	X	X					X	X	X	X				
8	X	X	X	X	X	X	X	X								

Rotary DIP Switches, Process Sealed, Through Hole and Surface Mount

"D" FLUSH ACTUATOR

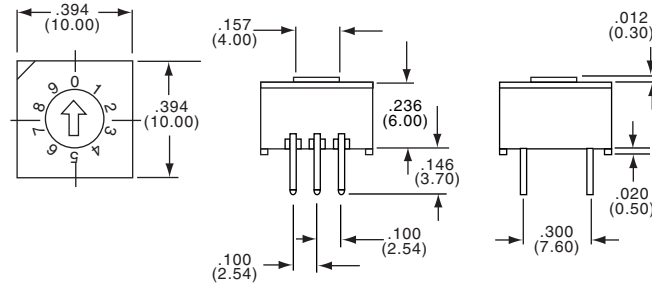

TERMINATIONS

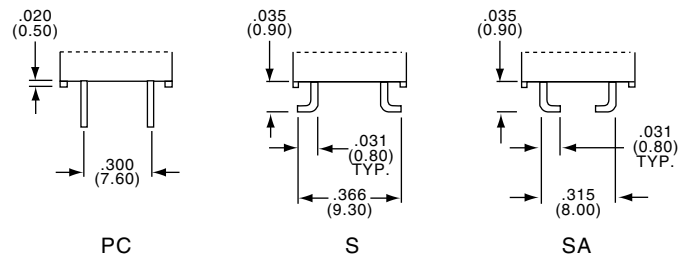

LAYOUTS

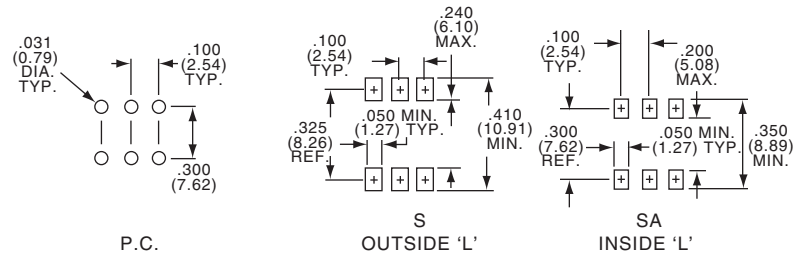

HOW TO ORDER

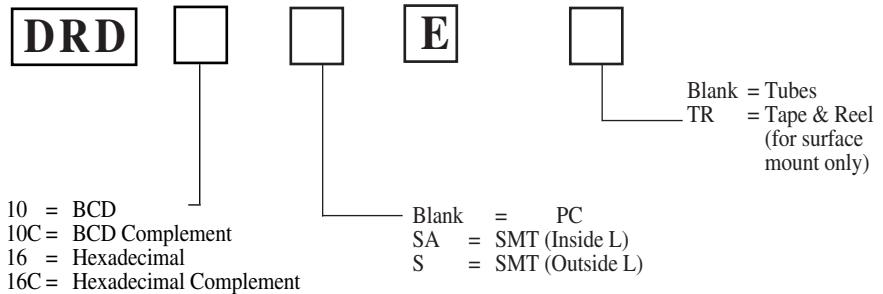

Rotary DIP Switches, Unsealed, Through Hole, Straight and Right-Angle

FEATURES:

- High pressure contacts (140K PSI) provide 20,000 Steps.
- Unique design utilizes high pressure pin-point sliding contacts to penetrate contaminants on contact surface.
- Terminals insert molded into base.

- Screwdriver, knob and shaft (plastic and steel) type actuators available in both upright and right angle versions.

- 10 And 16 position versions with both real and complement codes.

Note: Common terminals connected internally.

MATERIAL SPECIFICATIONS:

ContactsGold flashed copper alloy

TerminalsTin Lead Plated

Base, Rotor, CasePolyester

TYPICAL PERFORMANCE CHARACTERISTICS:

Contact Rating0.4 VA @ 20 VDC

Initial Contact Resistance50 Milliohms max. @ 2 VDC

Insulation Resistance1,000 Megohms min. @ 100 VDC

Dielectric Strength300 VAC RMS @ sea level

ENVIRONMENTAL SPECIFICATIONS:

Operating Temperature.....-22°F to +185°F (-30°C to +85°C)

Storage Temperature.....-49°F to +212°F (-45°C to +100°C)

Vibration Resistance.....Subjected to vibration of 10-55hz per second with a total amplitude of .06 in. in 3 mutually perpendicular directions for 2 hours each

Shock ResistanceWill withstand 50G acceleration in 3 different planes for a period of 11 milliseconds

Salt Spray TestWithstands an atmosphere of 5% salt water at temperature of 50°C

Hydrogen Sulfide TestWithstands an atmosphere of 15-20 PPM hydrogen sulfide gas at temperature of 40°C for 240 hours

Atmosphere Test.....Withstands an atmosphere of 30-50 PPM sulfide gas at a temperature of 40°C for 240 hours

Solder Heat ResistanceWithstands 5 sec. flow solder bath of 260°C when mounted on a .06" thick PC board per MIL-STD 202, Method 210



Example: DRW 10RA = Rotary Dip with
Wheel actuator
BDC -10 position
Right angle PC terminations

Series
Rotary Dips (blue case)

Actuator Style

- *D = Flush
- M = Mini plastic shaft
- W = Wheel
- S = Metal shaft

Circuit Type

- 10 = BCD
- 10C = BCD complement
- 16 = Hexadecimal
- 16C = Hexadecimal complement

HOW TO ORDER

Terminations

- Blank = PC
- RA = Right angle for DRM, DRW, DRS only
- RAE = Right angle, Auto Assembly Compatible for DRD type only

*DRD Available in RAE version only. For PC or SMT versions, see Pg. A24 DRD "E" Process Sealed Product.