



Chipsmall Limited consists of a professional team with an average of over 10 year of expertise in the distribution of electronic components. Based in Hongkong, we have already established firm and mutual-benefit business relationships with customers from,Europe,America and south Asia,supplying obsolete and hard-to-find components to meet their specific needs.

With the principle of “Quality Parts,Customers Priority,Honest Operation,and Considerate Service”,our business mainly focus on the distribution of electronic components. Line cards we deal with include Microchip,ALPS,ROHM,Xilinx,Pulse,ON,Everlight and Freescale. Main products comprise IC,Modules,Potentiometer,IC Socket,Relay,Connector.Our parts cover such applications as commercial,industrial, and automotives areas.

We are looking forward to setting up business relationship with you and hope to provide you with the best service and solution. Let us make a better world for our industry!



Contact us

Tel: +86-755-8981 8866 Fax: +86-755-8427 6832

Email & Skype: info@chipsmall.com Web: www.chipsmall.com

Address: A1208, Overseas Decoration Building, #122 Zhenhua RD., Futian, Shenzhen, China



TV02W5V0-G Thru. TV02W191-G

Working Peak Reverse Voltage:5.0-190 Volts

Peak Pulse Power:200 Watts

RoHS Device

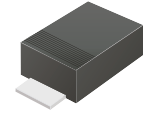

Features

- Glass passivated chip.
- Low leakage current.
- 200W peak pulse power capility with a 10/1000us waveform,repitive rate (duty cycle):0.01%.
- Uni and bidirectional unit.
- Excellent clamping capability.
- Very fast response time.

Mechanical data

- Case: Molded plastic.
- Epoxy: UL 94V-0 rate flame retardant.
- Lead: Solderable per MIL-STD-750, method 2026.
- Polarity: Color band denotes cathode end except bipolar.
- Mounting position: Any.
- Weight: 0.016 grams.

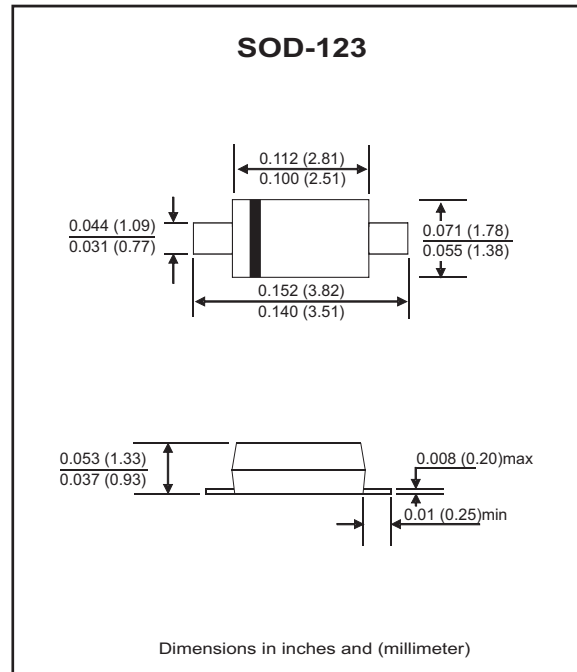

Circuit Diagram

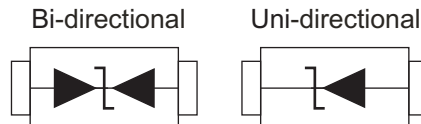

Maximum Rating and Electrical Characteristics

Ratings at 25°C ambient temperature unless otherwise specified.
 Single phase, half wave, 60Hz, resistive or inductive load.
 For capacitive load, derate current by 20%.

| Parameter | Symbol | Value | Unit |
|--|---------|----------------|------|
| Peak power dissipation at 10/1000µs waveform (Note 1) | PPP | 200 | W |
| Peak power dissipation at 8/20µs waveform (Note 1) | PPP | 1000 | W |
| Peak pulse current with a 10/1000µs waveform (Note 1) | IPP | See next table | A |
| Power dissipation on infinite heatsink at TL = 75°C | PD | 0.4 | W |
| Peak forward surge current, 8.3ms single half sone-wave undiresional only (Note 2) | IFSM | 20 | A |
| Max.instantaneous forward voltage at 25A for undiresional only | VF | 3.5 | V |
| Operating junction and storage temperature range | TJ,TSTG | -55 to +150 | °C |

Notes:

1. Non-repetitive current pulse, per Fig.3 and derated above TA=25°C per Fig.1
2. Measured on 8.3ms single half sine-wave or equivalent square wave, duty cycle=4 pulses per minute maximum.
3. Company reserves the right to improve product design , functions and reliability without notice.

Rating and Characteristic Curves (TV02W5V0-G Thru. TV02W191-G)

Fig. 1 - Pulse Derating Curve

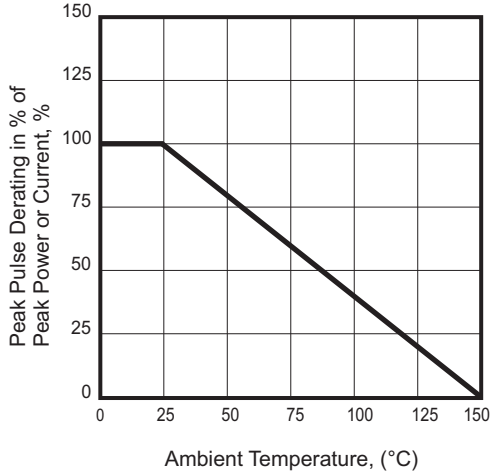

Fig.2 - Steady State Power Derating Curve

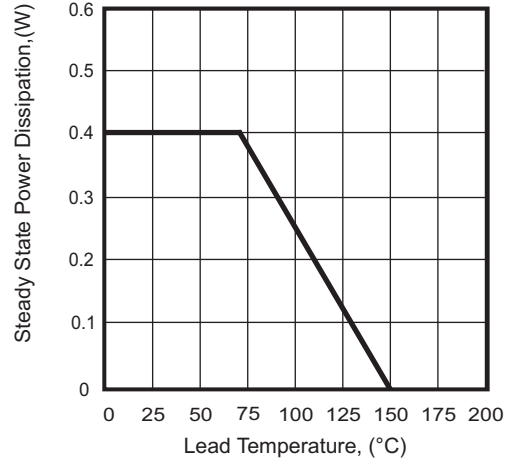

Fig. 3 - Pulse Waveform

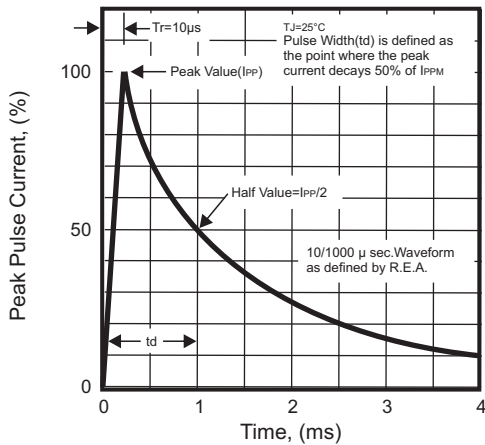

Fig. 4 - Peak Pulse Power Rating Curve

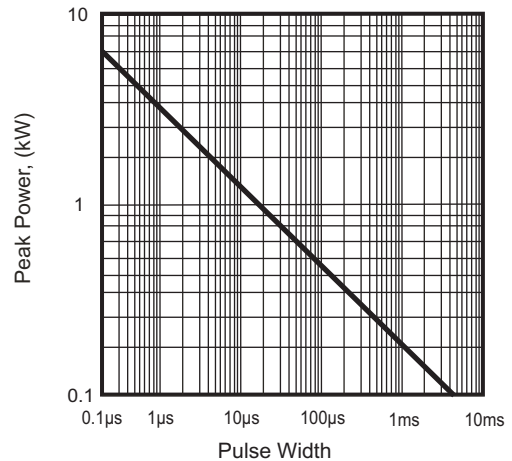

Fig. 5 - Maximum non-repetitive surge current

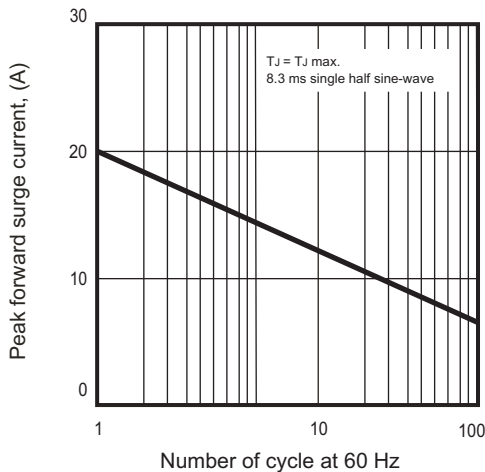
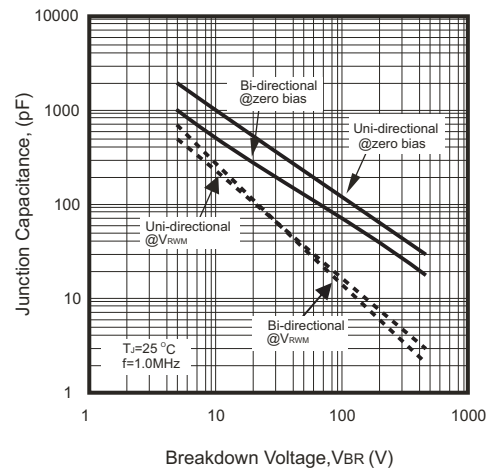

Fig.6 - Typical Junction Capacitance



SMD Transient Voltage Suppressor

Electrical Characteristics (TV02W5V0-G Thru. TV02W191-G)

| Part No | Absolute Maximum Rating (Ta=25°C) | | | | V _C (Max.) @ IPP | IPP @ 10/1000us | I _R @ V _{RWM} | Marking Code | |
|---------------|-----------------------------------|----------------------|----------------------|----------------|--------------------------------|--------------------|--------------------------------------|--------------|----|
| | V _{RWM} | V _{BR} Min. | V _{BR} Max. | I _T | | | | Uni | Bi |
| | (V) | (V) | (V) | (mA) | (V) | (A) | (uA) | | |
| TV02W5V0(B)-G | 5.0 | 6.40 | 7.00 | 10 | 9.20 | 21.74 | 400 | FE | KE |
| TV02W6V0(B)-G | 6.0 | 6.67 | 7.37 | 10 | 10.3 | 19.42 | 400 | FG | KG |
| TV02W6V5(B)-G | 6.5 | 7.22 | 7.98 | 10 | 11.2 | 17.86 | 250 | FK | KK |
| TV02W7V0(B)-G | 7.0 | 7.78 | 8.60 | 10 | 12.0 | 16.67 | 100 | FM | KM |
| TV02W7V5(B)-G | 7.5 | 8.33 | 9.21 | 1 | 12.9 | 15.50 | 50 | FP | KP |
| TV02W8V0(B)-G | 8.0 | 8.89 | 9.83 | 1 | 13.6 | 14.71 | 25 | FR | KR |
| TV02W8V5(B)-G | 8.5 | 9.44 | 10.40 | 1 | 14.4 | 13.89 | 10 | FT | KT |
| TV02W9V0(B)-G | 9.0 | 10.00 | 11.10 | 1 | 15.4 | 12.99 | 5 | FV | KV |
| TV02W100(B)-G | 10.0 | 11.10 | 12.30 | 1 | 17.0 | 11.76 | 2.5 | FX | KX |
| TV02W110(B)-G | 11.0 | 12.20 | 13.50 | 1 | 18.2 | 10.99 | 2.5 | FZ | KZ |
| TV02W120(B)-G | 12.0 | 13.30 | 14.70 | 1 | 19.9 | 10.05 | 2.5 | HE | LE |
| TV02W130(B)-G | 13.0 | 14.40 | 15.90 | 1 | 21.5 | 9.30 | 1 | HG | LG |
| TV02W140(B)-G | 14.0 | 15.60 | 17.20 | 1 | 23.2 | 8.62 | 1 | HK | LK |
| TV02W150(B)-G | 15.0 | 16.70 | 18.50 | 1 | 24.4 | 8.20 | 1 | HM | LM |
| TV02W160(B)-G | 16.0 | 17.80 | 19.70 | 1 | 26.0 | 7.69 | 1 | HP | LP |
| TV02W170(B)-G | 17.0 | 18.90 | 20.90 | 1 | 27.6 | 7.25 | 1 | HR | LR |
| TV02W180(B)-G | 18.0 | 20.00 | 22.10 | 1 | 29.2 | 6.85 | 1 | HT | LT |
| TV02W190(B)-G | 19.0 | 21.10 | 23.30 | 1 | 30.6 | 6.54 | 1 | HB | LB |
| TV02W200(B)-G | 20.0 | 22.20 | 24.50 | 1 | 32.4 | 6.17 | 1 | HV | LV |
| TV02W220(B)-G | 22.0 | 24.4 | 26.90 | 1 | 35.5 | 5.63 | 1 | HX | LX |
| TV02W240(B)-G | 24.0 | 26.70 | 29.50 | 1 | 38.9 | 5.14 | 1 | HZ | LZ |
| TV02W260(B)-G | 26.0 | 28.90 | 31.90 | 1 | 42.1 | 4.75 | 1 | JE | ME |
| TV02W280(B)-G | 28.0 | 31.10 | 34.40 | 1 | 45.4 | 4.41 | 1 | JG | MG |
| TV02W300(B)-G | 30.0 | 33.30 | 36.80 | 1 | 48.4 | 4.13 | 1 | JK | MK |
| TV02W330(B)-G | 33.0 | 36.70 | 40.60 | 1 | 53.3 | 3.75 | 1 | JM | MM |
| TV02W360(B)-G | 36.0 | 40.00 | 44.20 | 1 | 58.1 | 3.44 | 1 | JP | MP |
| TV02W400(B)-G | 40.0 | 44.40 | 49.10 | 1 | 64.5 | 3.10 | 1 | JR | MR |
| TV02W430(B)-G | 43.0 | 47.80 | 52.80 | 1 | 69.4 | 2.88 | 1 | JT | MT |
| TV02W450(B)-G | 45.0 | 50.00 | 55.30 | 1 | 72.7 | 2.75 | 1 | JV | MV |
| TV02W480(B)-G | 48.0 | 53.30 | 58.90 | 1 | 77.4 | 2.58 | 1 | JX | MX |
| TV02W510(B)-G | 51.0 | 56.70 | 62.70 | 1 | 82.4 | 2.43 | 1 | JZ | MZ |
| TV02W540(B)-G | 54.0 | 60.00 | 66.30 | 1 | 87.1 | 2.30 | 1 | XE | NE |
| TV02W580(B)-G | 58.0 | 64.40 | 71.20 | 1 | 93.6 | 2.14 | 1 | XG | NG |
| TV02W600(B)-G | 60.0 | 66.70 | 73.70 | 1 | 96.8 | 2.07 | 1 | XK | NK |
| TV02W640(B)-G | 64.0 | 71.10 | 78.60 | 1 | 103.0 | 1.94 | 1 | XM | NM |
| TV02W700(B)-G | 70.0 | 77.80 | 86.00 | 1 | 113.0 | 1.77 | 1 | XP | NP |
| TV02W750(B)-G | 75.0 | 83.30 | 92.10 | 1 | 121.0 | 1.65 | 1 | XR | NR |
| TV02W780(B)-G | 78.0 | 86.70 | 95.80 | 1 | 126.0 | 1.59 | 1 | XT | NT |
| TV02W800(B)-G | 80.0 | 88.80 | 97.60 | 1 | 129.0 | 1.55 | 1 | XB | NB |
| TV02W850(B)-G | 85.0 | 94.40 | 104.00 | 1 | 137.0 | 1.46 | 1 | XV | NV |
| TV02W900(B)-G | 90.0 | 100.00 | 111.00 | 1 | 146.0 | 1.37 | 1 | XX | NX |
| TV02W101(B)-G | 100.0 | 111.00 | 123.00 | 1 | 162.0 | 1.23 | 1 | XZ | NZ |
| TV02W111(B)-G | 110.0 | 122.00 | 135.00 | 1 | 177.0 | 1.13 | 1 | TE | PE |
| TV02W121(B)-G | 120.0 | 133.00 | 147.00 | 1 | 193.0 | 1.04 | 1 | TG | PG |
| TV02W131(B)-G | 130.0 | 144.00 | 159.00 | 1 | 209.0 | 0.96 | 1 | TK | PK |
| TV02W141(B)-G | 140.0 | 155.00 | 171.00 | 1 | 224.0 | 0.89 | 1 | TB | PB |
| TV02W151(B)-G | 150.0 | 167.00 | 185.00 | 1 | 243.0 | 0.82 | 1 | TM | PM |
| TV02W161(B)-G | 160.0 | 178.00 | 197.00 | 1 | 259.0 | 0.77 | 1 | TP | PP |
| TV02W171(B)-G | 170.0 | 189.00 | 209.00 | 1 | 275.0 | 0.73 | 1 | TR | PR |
| TV02W181(B)-G | 180.0 | 200.00 | 220.00 | 1 | 292.0 | 0.69 | 1 | TT | PT |
| TV02W191(B)-G | 190.0 | 211.00 | 232.00 | 1 | 308.0 | 0.69 | 1 | TV | PV |

Notes:

1. Suffix B after part number to specify bi-directional devices.
2. For Bi-Directional devices having V_R of 10 volts and under, the I_R limit is double.
3. Company reserves the right to improve product design , functions and reliability without notice.

Reel Taping Specification

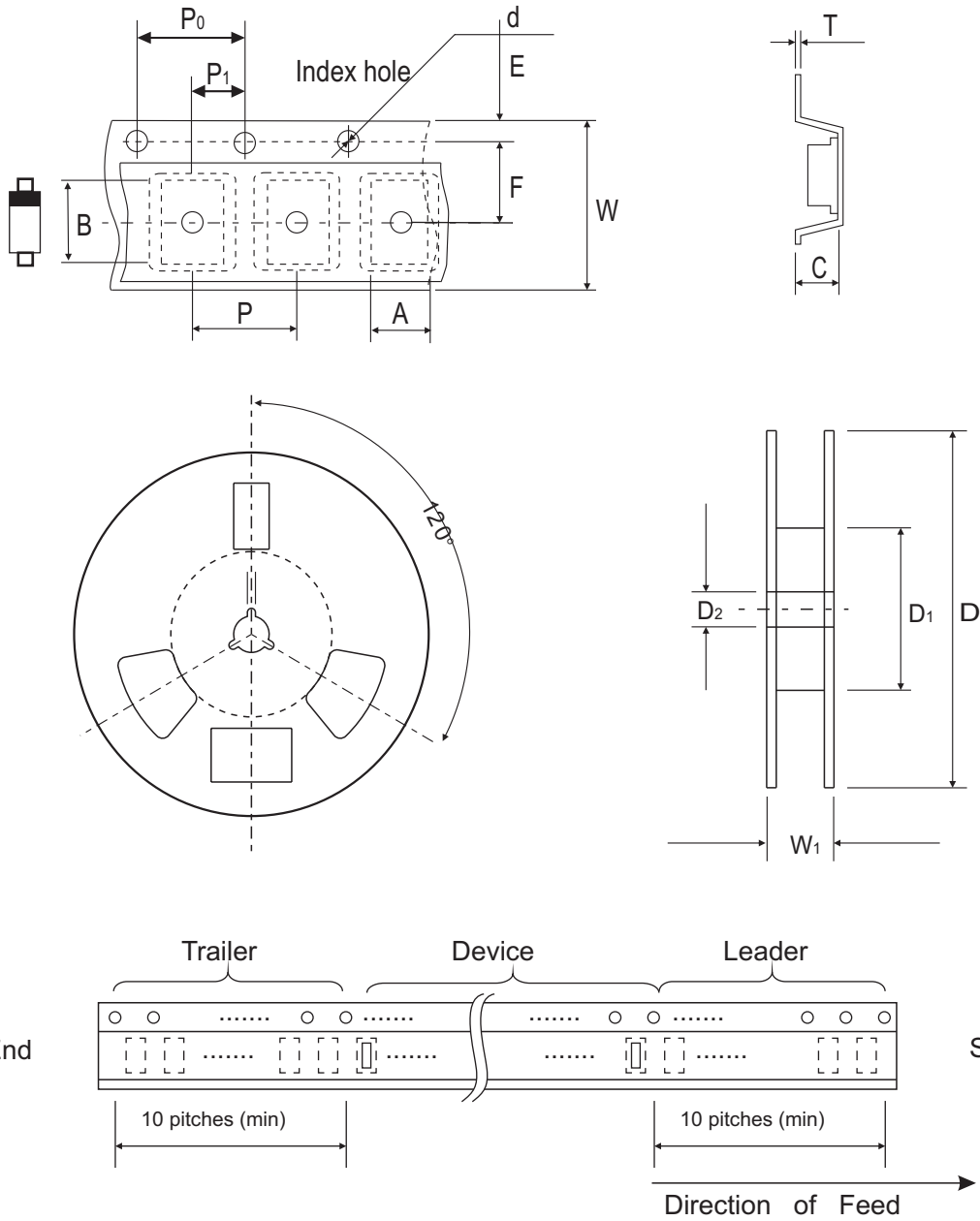

| SOD-123 | SYMBOL | A | B | C | d | D | D1 | D2 |
|---------|--------|---------------|---------------|---------------|---------------|---------------|---------------|---------------|
| | (mm) | 1.85 ± 0.10 | 3.94 ± 0.10 | 1.57 ± 0.10 | 1.55 ± 0.10 | 178 ± 1.00 | 54.40 ± 0.40 | 13.0 ± 0.20 |
| | (inch) | 0.073 ± 0.004 | 0.155 ± 0.004 | 0.062 ± 0.004 | 0.061 ± 0.004 | 7.008 ± 0.039 | 2.142 ± 0.016 | 0.512 ± 0.008 |

| SOD-123 | SYMBOL | E | F | P | P0 | P1 | W | W1 |
|---------|--------|---------------|---------------|---------------|---------------|---------------|----------------------|---------------|
| | (mm) | 1.75 ± 0.10 | 3.50 ± 0.05 | 4.00 ± 0.10 | 4.00 ± 0.10 | 2.00 ± 0.10 | 8.00 ± 0.30/-0.10 | 9.50 ± 1.00 |
| | (inch) | 0.069 ± 0.004 | 0.138 ± 0.002 | 0.158 ± 0.004 | 0.158 ± 0.004 | 0.079 ± 0.004 | 0.315 ± 0.012/-0.004 | 0.374 ± 0.039 |

Suggested PAD Layout

| SIZE | SOD-123 | |
|------|---------|--------|
| | (mm) | (inch) |
| A | 3.35 | 0.132 |
| B | 0.80 | 0.032 |
| C | 1.00 | 0.039 |
| D | 4.15 | 0.163 |
| E | 2.55 | 0.100 |

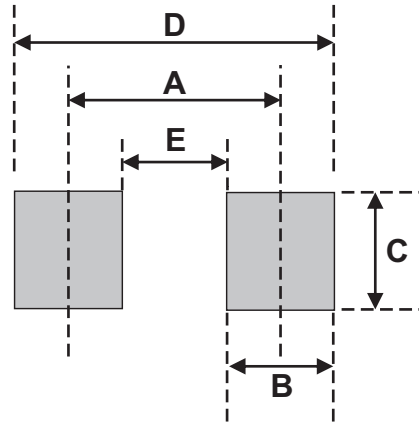

Standard Packaging

| Case Type | REEL PACK | |
|-----------|-----------------|---------------------|
| | REEL (pcs) | Reel Size (inch) |
| SOD-123 | 3,000 | 7 |