



Chipsmall Limited consists of a professional team with an average of over 10 year of expertise in the distribution of electronic components. Based in Hongkong, we have already established firm and mutual-benefit business relationships with customers from,Europe,America and south Asia,supplying obsolete and hard-to-find components to meet their specific needs.

With the principle of “Quality Parts,Customers Priority,Honest Operation,and Considerate Service”,our business mainly focus on the distribution of electronic components. Line cards we deal with include Microchip,ALPS,ROHM,Xilinx,Pulse,ON,Everlight and Freescale. Main products comprise IC,Modules,Potentiometer,IC Socket,Relay,Connector.Our parts cover such applications as commercial,industrial, and automotives areas.

We are looking forward to setting up business relationship with you and hope to provide you with the best service and solution. Let us make a better world for our industry!



## Contact us

Tel: +86-755-8981 8866 Fax: +86-755-8427 6832

Email & Skype: info@chipsmall.com Web: www.chipsmall.com

Address: A1208, Overseas Decoration Building, #122 Zhenhua RD., Futian, Shenzhen, China



## TV04A5V0-HF Thru. TV04A441-HF

Working Peak Reverse Voltage: 5.0 to 440 Volts

Power Dissipation: 400 Watts

RoHS Device  
Halogen Free

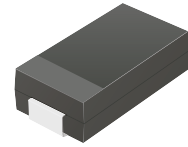

### Features

- Glass passivated chip.
- 400W peak pulse power capability with a 10/1000  $\mu$ s waveform, repetitive rate (duty cycle):0.01%
- Low leakage.
- Uni and Bidirectional unit.
- Excellent clamping capability.
- Very fast response time.
- UL recognized file # E349157  Range: TV04A5V0J(B) thru. TV04A240J(B)

### Mechanical data

- Epoxy: UL 94V-0 rate flame retardant.
- Case: SMA/DO-214AC, molded plastic.
- Terminals: solderable per MIL-STD-750, method 2026.
- Polarity: Color band denotes cathode end except bipolar.
- Weight: 0.069 gram (approx.)

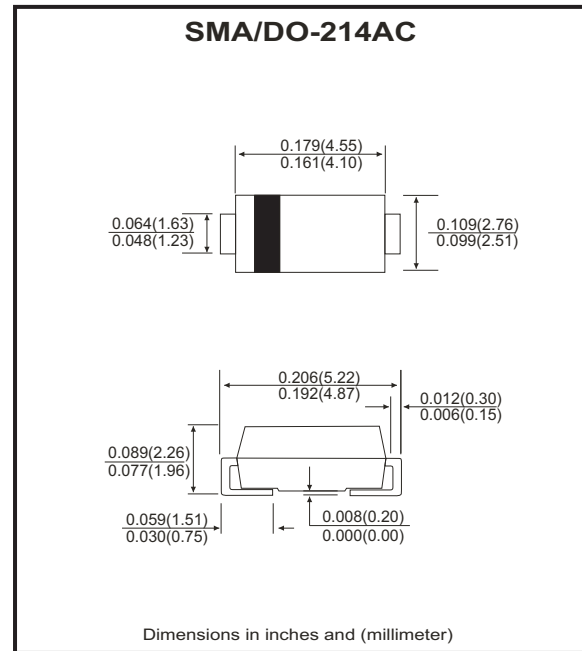

### Maximum Ratings and Electrical Characteristics

Ratings at 25 °C ambient temperature unless otherwise specified.  
Single phase, half wave, 60Hz, resistive or inductive load.  
For capacitive load, derate current by 20%.

Characteristics	Symbol	Value	Units
Peak power dissipation on 10/1000 $\mu$ S waveform (Note1)	P <sub>PP</sub>	400	W
Peak pulse current on 10/1000 $\mu$ S waveform (Note 1)	I <sub>PP</sub>	See Next Table	A
Steady state power dissipation at T <sub>L</sub> =75°C	P <sub>D</sub>	1.0	W
Peak forward surge current, 8.3mS single half sine-wave unidirectional only (Note 2)	I <sub>FSM</sub>	40	A
Maximum instantaneous forward voltage at 25.0A for unidirectional only (Note 3)	V <sub>F</sub>	3.5/5.0	V
Operating junction and storage temperature	T <sub>J</sub> , T <sub>STG</sub>	-55 to +150	°C

Notes: 1. Non-repetitive current pulse, per Fig. 5 and derated above T<sub>A</sub>=25°C, per Fig. 1.  
2. Measured on 8.3mS single half sine-wave or equare wave,duty cycle=4 pulses per minute maximum.  
3. V<sub>F</sub><3.5V for devices of V<sub>BR</sub><200V and V<sub>F</sub><5.0V for devices of V<sub>BR</sub>>201V

## RATING AND CHARACTERISTIC CURVES (TV04A5V0-HF thru TV04A441-HF)

Fig.1 - Pulse Derating Curve

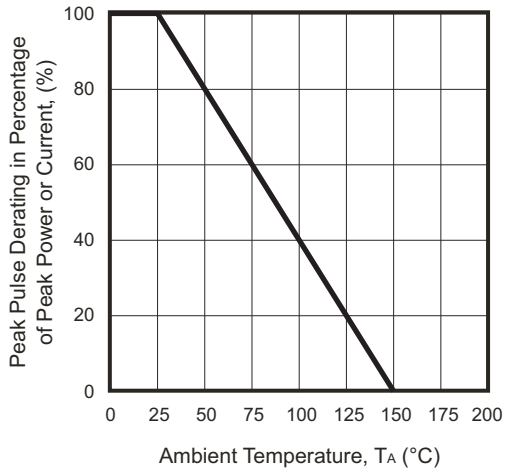

Fig.2 - Maximum Non-Repetitive Surge Current

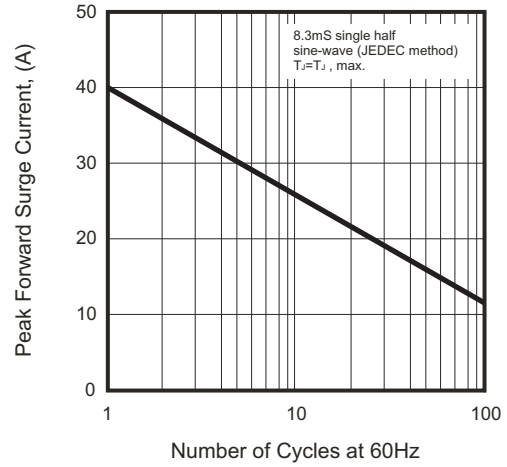

Fig.3 - Steady State Power Derating Curve

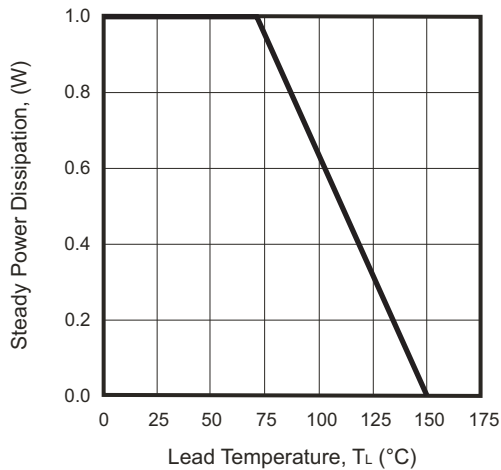

Fig.4 - Peak Pulse Power Rating Curve

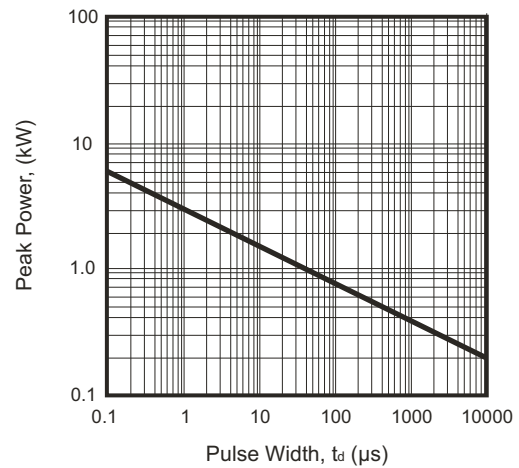

Fig.5 - Pulse Waveform

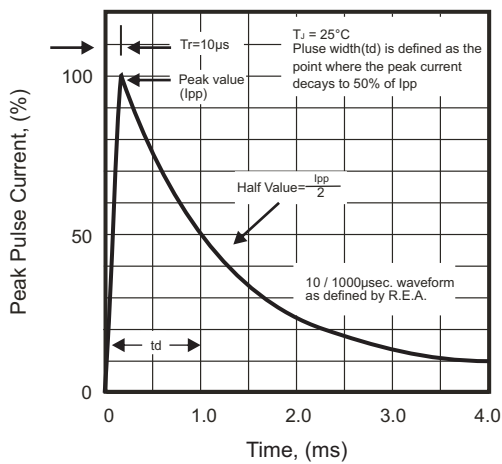
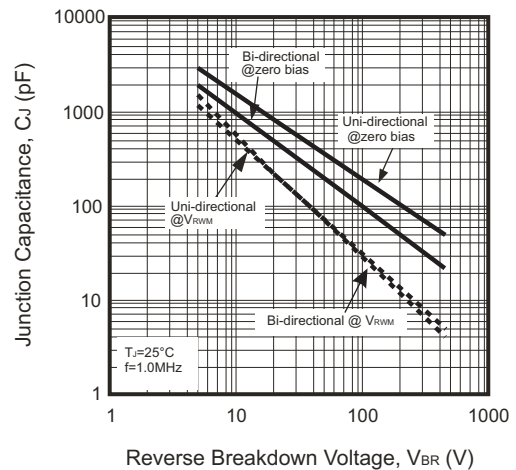

Fig.6 - Typical Junction Capacitance



# SMD Transient Voltage Suppressor

## Electrical Characteristics (TV04A5V0-HF Thru. TV04A441-HF)

Part No.	Breakdown voltage V <sub>BR</sub> @ I <sub>T</sub>			Maximum Reverse Leakage @V <sub>RWM</sub> I <sub>R</sub> (uA)	Working Peak Reverse Voltage V <sub>RWM</sub> (V)	Maximum Reverse Surge Current I <sub>PP</sub> (A)	Maximum Clamping Voltage @I <sub>PP</sub> V <sub>c</sub> (V)	Device Marking Code	
	Min. (V)	Max. (V)	I <sub>T</sub> (mA)					UNI	BI
TV04A5V0J(B)-HF	6.40	7.00	10	800	5.0	43.48	9.2	AE	WE
TV04A6V0J(B)-HF	6.67	7.37	10	800	6.0	38.83	10.3	AG	WG
TV04A6V5J(B)-HF	7.22	7.98	10	500	6.5	35.71	11.2	AK	WK
TV04A7V0J(B)-HF	7.78	8.60	10	200	7.0	33.33	12.0	AM	WM
TV04A7V5J(B)-HF	8.33	9.21	1	100	7.5	31.01	12.9	AP	WP
TV04A8V0J(B)-HF	8.89	9.83	1	50	8.0	29.41	13.6	AR	WR
TV04A8V5J(B)-HF	9.44	10.40	1	10	8.5	27.78	14.4	AT	WT
TV04A9V0J(B)-HF	10.00	11.10	1	5	9.0	25.97	15.4	AV	WV
TV04A100J(B)-HF	11.10	12.30	1	5	10.0	23.53	17.0	AX	WX
TV04A110J(B)-HF	12.20	13.50	1	1	11.0	21.98	18.2	AZ	WZ
TV04A120J(B)-HF	13.30	14.70	1	1	12.0	20.10	19.9	BE	XE
TV04A130J(B)-HF	14.40	15.90	1	1	13.0	18.60	21.5	BG	XG
TV04A140J(B)-HF	15.60	17.20	1	1	14.0	17.24	23.2	BK	XK
TV04A150J(B)-HF	16.70	18.50	1	1	15.0	16.39	24.4	BM	XM
TV04A160J(B)-HF	17.80	19.70	1	1	16.0	15.38	26.0	BP	XP
TV04A170J(B)-HF	18.90	20.90	1	1	17.0	14.49	27.6	BR	XR
TV04A180J(B)-HF	20.00	22.10	1	1	18.0	13.70	29.2	BT	XT
TV04A190J(B)-HF	21.10	23.30	1	1	19.0	13.00	30.8	BB	XB
TV04A200J(B)-HF	22.20	24.50	1	1	20.0	12.35	32.4	BV	XV
TV04A220J(B)-HF	24.40	26.90	1	1	22.0	11.27	35.5	BX	XX
TV04A240J(B)-HF	26.70	29.50	1	1	24.0	10.28	38.9	BZ	XZ
TV04A260J(B)-HF	28.90	31.90	1	1	26.0	9.50	42.1	CE	YE
TV04A280J(B)-HF	31.10	34.40	1	1	28.0	8.81	45.4	CG	YG
TV04A300J(B)-HF	33.30	36.80	1	1	30.0	8.26	48.4	CK	YK
TV04A330J(B)-HF	36.70	40.60	1	1	33.0	7.50	53.3	CM	YM
TV04A360J(B)-HF	40.00	44.20	1	1	36.0	6.88	58.1	CP	YP
TV04A400J(B)-HF	44.40	49.10	1	1	40.0	6.20	64.5	CR	YR
TV04A430J(B)-HF	47.80	52.80	1	1	43.0	5.76	69.4	CT	YT
TV04A450J(B)-HF	50.00	55.30	1	1	45.0	5.50	72.7	CV	YV
TV04A480J(B)-HF	53.30	58.90	1	1	48.0	5.17	77.4	CX	YX
TV04A510J(B)-HF	56.70	62.70	1	1	51.0	4.85	82.4	CZ	YZ
TV04A540J(B)-HF	60.00	66.30	1	1	54.0	4.59	87.1	RE	ZE
TV04A580J(B)-HF	64.40	71.20	1	1	58.0	4.27	93.6	RG	ZG
TV04A600J(B)-HF	66.70	73.70	1	1	60.0	4.13	96.8	RK	ZK
TV04A640J(B)-HF	71.10	78.60	1	1	64.0	3.88	103.0	RM	ZM
TV04A700J(B)-HF	77.80	86.00	1	1	70.0	3.54	113.0	RP	ZP
TV04A750J(B)-HF	83.30	92.10	1	1	75.0	3.31	121.0	RR	ZR
TV04A780J(B)-HF	86.70	95.80	1	1	78.0	3.17	126.0	RT	ZT
TV04A800J(B)-HF	88.80	97.60	1	1	80.0	3.09	129.6	RB	ZB
TV04A850J(B)-HF	94.40	104.00	1	1	85.0	2.92	137.0	RV	ZV

Company reserves the right to improve product design , functions and reliability without notice.

REV:F

## Electrical Characteristics (TV04A5V0-HF Thru. TV04A441-HF)

Part No.	Breakdown voltage V <sub>BR</sub> @ I <sub>T</sub>			Maximum Reverse Leakage @V <sub>RWM</sub> I <sub>R</sub> (uA)	Working Peak Reverse Voltage V <sub>RWM</sub> (V)	Maximum Reverse Surge Current I <sub>PP</sub> (A)	Maximum Clamping Voltage @I <sub>PP</sub> V <sub>c</sub> (V)	Device Marking Code	
	Min. (V)	Max. (V)	I <sub>T</sub> (mA)					UNI	BI
TV04A900J(B)-HF	100.0	111.0	1	1	90.0	2.74	146.0	RX	ZX
TV04A101J(B)-HF	111.0	123.0	1	1	100.0	2.47	162.0	RZ	ZZ
TV04A111J(B)-HF	122.0	135.0	1	1	110.0	2.26	177.0	SE	VE
TV04A121J(B)-HF	133.0	147.0	1	1	120.0	2.07	193.0	SG	VG
TV04A131J(B)-HF	144.0	159.0	1	1	130.0	1.91	209.0	SK	VK
TV04A141J(B)-HF	155.0	171.0	1	1	140.0	1.76	226.8	SB	VB
TV04A151J(B)-HF	167.0	185.0	1	1	150.0	1.65	243.0	SM	VM
TV04A161J(B)-HF	178.0	197.0	1	1	160.0	1.54	259.0	SP	VP
TV04A171J(B)-HF	189.0	209.0	1	1	170.0	1.45	275.0	SR	VR
TV04A181J(B)-HF	200.0	220.0	1	1	180.0	1.37	291.6	ST	VT
TV04A191J(B)-HF	211.0	232.0	1	1	190.0	1.30	307.8	SV	VV
TV04A201J(B)-HF	224.0	247.0	1	1	200.0	1.23	324.0	SW	VW
TV04A221J(B)-HF	246.0	272.0	1	1	220.0	1.12	356.0	SX	VX
TV04A251J(B)-HF	279.0	309.0	1	1	250.0	0.99	405.0	SZ	VZ
TV04A301J(B)-HF	335.0	371.0	1	1	300.0	0.82	486.0	DE	HE
TV04A351J(B)-HF	391.0	432.0	1	1	350.0	0.71	567.0	DG	HG
TV04A401J(B)-HF	447.0	494.0	1	1	400.0	0.62	648.0	DK	HK
TV04A441J(B)-HF	492.0	543.0	1	1	440.0	0.56	713.0	DM	HM

Note:

- 1) Suffix J denotes 5% tolerance devices.
- 2) Suffix B after part number to specify Bi-directional devices.
- 3) For Bi-Directional devices having V<sub>R</sub> of 10 volts and under, the I<sub>R</sub> limit is double.

## Reel Taping Specification

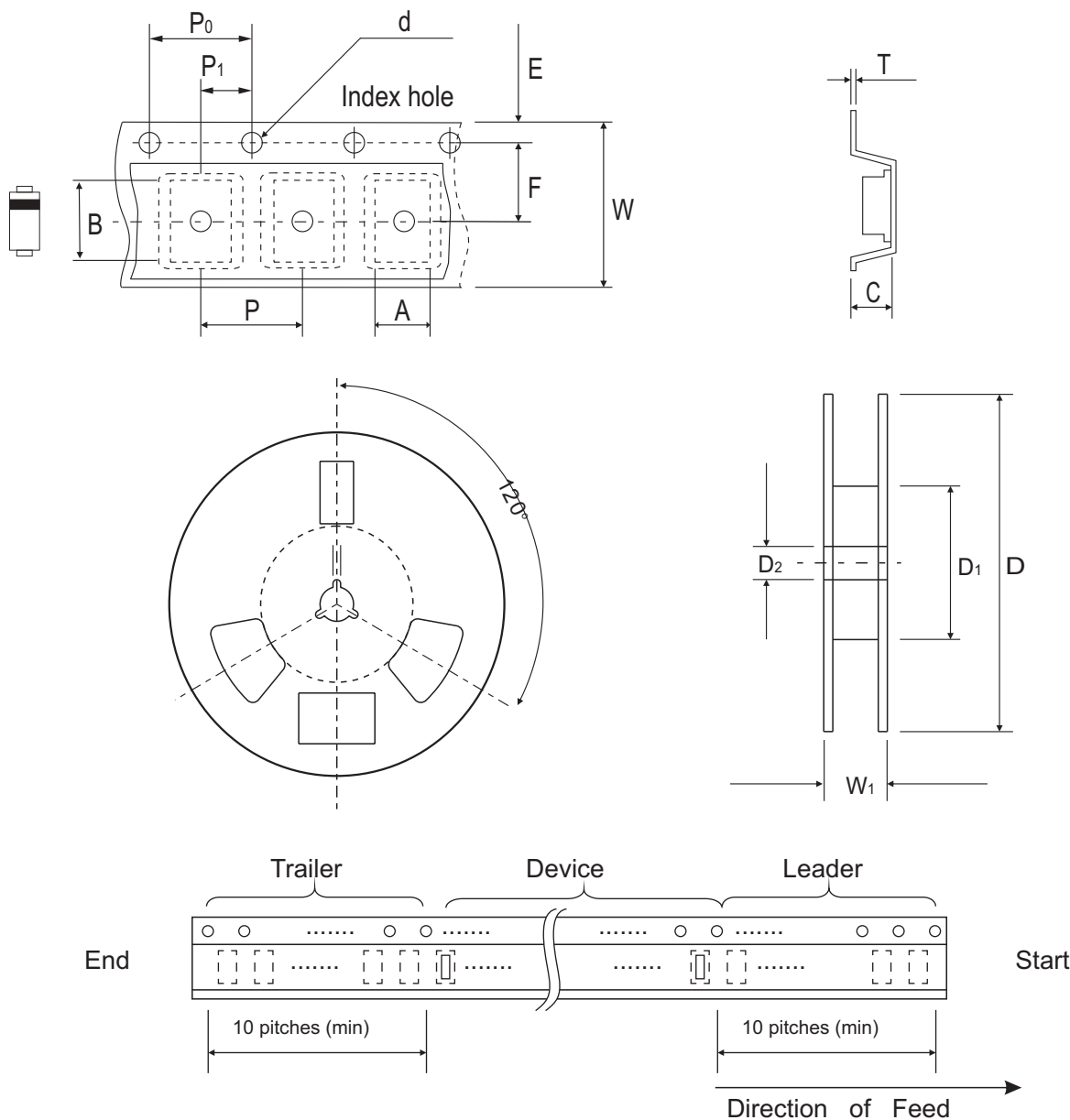

SMA/DO-214AC	SYMBOL	A	B	C	d	D	D1	D2
	(mm)	2.79 ± 0.10	5.33 ± 0.10	4.50 (max)	1.75 ± 0.10	330MAX	50.0 MIN.	13.0 ± 0.2
	(inch)	0.110 ± 0.004	0.210 ± 0.004	0.177 (max)	0.069 ± 0.004	13.00MAX	1.969 MIN.	0.512 ± 0.008

SMA/DO-214AC	SYMBOL	E	F	P	P0	P1	W	W1
	(mm)	1.75 ± 0.10	5.50 ± 0.05	4.00 ± 0.10	4.00 ± 0.10	2.00 ± 0.05	12.0 ± 0.30	18.4 MAX.
	(inch)	0.069 ± 0.004	0.216 ± 0.002	0.157 ± 0.004	0.157 ± 0.004	0.079 ± 0.002	0.472 ± 0.012	0.724 MAX.

Company reserves the right to improve product design, functions and reliability without notice.

REV:F

## Marking Code

1. **C**: COMCHIP

2. **○**: Package

○	PKG
A	SMA
B	SMB
C	SMC

3. **XX**: Marking code (see Page. 3~4)

4. **█**: Cathod Band

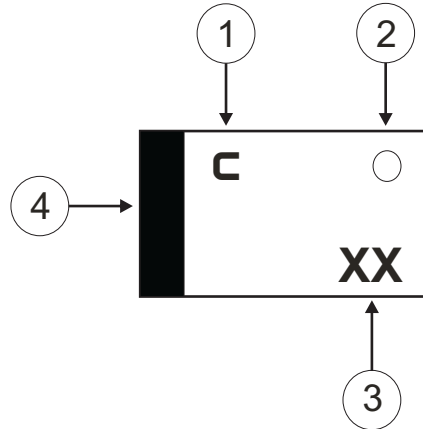

## Suggested PAD Layout

SIZE	DO-214AC(SMA)	
	(mm)	(inch)
A	5.28	0.208
B	1.88 MAX	0.074 MAX
C	1.52 MIN	0.060 MIN
D	1.68 MIN	0.066 MIN

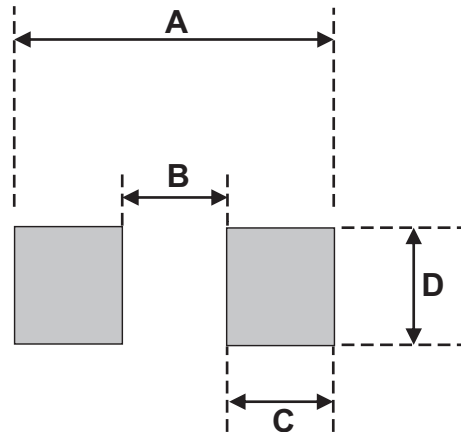

## Standard Packaging

Case Type	REEL PACK	
	REEL ( pcs )	Reel Size (inch)
SMA/DO-214AC	5,000	13