



Chipsmall Limited consists of a professional team with an average of over 10 year of expertise in the distribution of electronic components. Based in Hongkong, we have already established firm and mutual-benefit business relationships with customers from,Europe,America and south Asia,supplying obsolete and hard-to-find components to meet their specific needs.

With the principle of “Quality Parts,Customers Priority,Honest Operation,and Considerate Service”,our business mainly focus on the distribution of electronic components. Line cards we deal with include Microchip,ALPS,ROHM,Xilinx,Pulse,ON,Everlight and Freescale. Main products comprise IC,Modules,Potentiometer,IC Socket,Relay,Connector.Our parts cover such applications as commercial,industrial, and automotives areas.

We are looking forward to setting up business relationship with you and hope to provide you with the best service and solution. Let us make a better world for our industry!



Contact us

Tel: +86-755-8981 8866 Fax: +86-755-8427 6832

Email & Skype: info@chipsmall.com Web: www.chipsmall.com

Address: A1208, Overseas Decoration Building, #122 Zhenhua RD., Futian, Shenzhen, China





ES Series
RF Transmitter
Data Guide

Wireless made simple[®]

Warning: Linx radio frequency ("RF") products may be used to control machinery or devices remotely, including machinery or devices that can cause death, bodily injuries, and/or property damage if improperly or inadvertently triggered, particularly in industrial settings or other applications implicating life-safety concerns. No Linx Technologies product is intended for use in any application without redundancies where the safety of life or property is at risk.

The customers and users of devices and machinery controlled with RF products must understand and must use all appropriate safety procedures in connection with the devices, including without limitation, using appropriate safety procedures to prevent inadvertent triggering by the user of the device and using appropriate security codes to prevent triggering of the remote controlled machine or device by users of other remote controllers.

Do not use this or any Linx product to trigger an action directly from the data line or RSSI lines without a protocol or encoder/decoder to validate the data. Without validation, any signal from another unrelated transmitter in the environment received by the module could inadvertently trigger the action.

All RF products are susceptible to RF interference that can prevent communication. RF products without frequency agility or hopping implemented are more subject to interference. This module does not have a frequency hopping protocol built in.

Do not use any Linx product over the limits in this data guide. Excessive voltage or extended operation at the maximum voltage could cause product failure. Exceeding the reflow temperature profile could cause product failure which is not immediately evident.

Do not make any physical or electrical modifications to any Linx product. This will void the warranty and regulatory and UL certifications and may cause product failure which is not immediately evident.

Table of Contents

- 1 [Description](#)
- 1 [Features](#)
- 1 [Applications](#)
- 2 [Ordering Information](#)
- 2 [Absolute Maximum Ratings](#)
- 2 [Electrical Specifications](#)
- 4 [Typical Performance Graphs](#)
- 6 [Pin Assignments](#)
- 6 [Pin Descriptions](#)
- 7 [Module Description](#)
- 8 [Theory of Operation](#)
- 8 [Using the Divided Clock Output \(/CLK\)](#)
- 9 [Using LADJ](#)
- 10 [Using the PDN Line](#)
- 10 [Using the LO_V_D Line](#)
- 11 [Typical Applications](#)
- 12 [ESD Concerns](#)
- 13 [Power Supply Requirements](#)
- 13 [Protocol Guidelines](#)
- 14 [Interference Considerations](#)
- 15 [Pad Layout](#)
- 15 [Board Layout Guidelines](#)
- 17 [Microstrip Details](#)
- 18 [Production Guidelines](#)
- 18 [Hand Assembly](#)
- 18 [Automated Assembly](#)
- 20 [Helpful Application Notes From Linx](#)
- 21 [Antenna Considerations](#)
- 22 [General Antenna Rules](#)

ES Series RF Transmitter Data Guide



Description

Housed in a tiny SMD package, the ES Series offers an unmatched combination of features, performance and cost-effectiveness. The transmitter utilizes an advanced FM / FSK-based synthesized architecture to provide superior performance and noise immunity when compared to AM / OOK solutions. A 56kbps maximum data rate and wide-range analog capability make the ES Series equally at home with digital data or analog sources. It provides a host of useful features including power down, output power adjustment, low voltage detect and a microprocessor clock source. The ES operates in the 900MHz (US) or 869MHz (EU) band, which in North America allows a wide variety of applications, including data links, audio links, home and industrial automation, security, remote control / command and monitoring. Like all Linx modules, the ES Series requires no tuning or external RF components except an antenna.

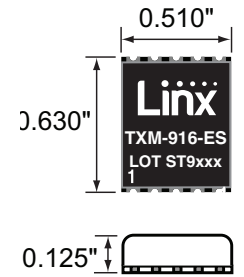



Figure 1: Package Dimensions

Features

- Ultra-compact SMD package
- FM / FSK modulation
- Wide bandwidth (20Hz to 28kHz)
- Very low current consumption
- Data rates to 56,000bps
- User power-down input
- Low-voltage detect output
- Microprocessor clock output
- No production tuning
- No external RF components needed
- Precision-frequency synthesized architecture
- Direct interface to analog and digital sources
- Excellent cost / performance ratio

Applications

- Wireless Data Transfer
- Wireless Analog / Audio
- Home / Industrial Automation
- Keyless Entry
- Remote Control
- Fire / Security Alarms
- Wireless Networks
- Remote Status Sensing / Telemetry
- Long-Range RFID
- RS-232 / 485 Data Links
- Voice / Music Links / Intercom

 **Warning:** This product incorporates numerous static-sensitive components. Always wear an ESD wrist strap and observe proper ESD handling procedures when working with this device. Failure to observe this precaution may result in module damage or failure.

Ordering Information

Ordering Information	
Part Number	Description
TXM-869-ES	ES Series Transmitter 869MHz
TXM-916-ES	ES Series Transmitter 916MHz
RXM-869-ES	ES Series Receiver 869MHz
RXM-916-ES	ES Series Receiver 916MHz
EVAL-***-ES	Basic Evaluation Kit
MDEV-***-ES	Master Development System

*** = Frequency
Receivers are supplied in tubes of 40 pcs.

Figure 2: Ordering Information

Absolute Maximum Ratings

Absolute Maximum Ratings				
Supply Voltage V_{CC}	-0.3	to	+4.0	VDC
Any Input or Output Pin	-0.5	to	$V_{CC} + 0.5$	VDC
Operating Temperature	0	to	+70	°C
Storage Temperature	-40	to	+90	°C
Soldering Temperature	255°C for 10 seconds			

Exceeding any of the limits of this section may lead to permanent damage to the device. Furthermore, extended operation at these maximum ratings may reduce the life of this device.

Figure 3: Absolute Maximum Ratings

Electrical Specifications

ES Series Transmitter Specifications						
Parameter	Symbol	Min.	Typ.	Max.	Units	Notes
Power Supply						
Operating Voltage	V_{CC}	2.1	3.0	4.0	VDC	
Supply Current	I_{CC}	5.5	7.0	8.5	mA	
Power-Down Current	I_{PDN}		90.0		μA	7
Transmit Section						
Transmit Frequency	F_C					
TXM-916-ES			916.48		MHz	4
TXM-869-ES			869.85		MHz	4

ES Series Transmitter Specifications						
Parameter	Symbol	Min.	Typ.	Max.	Units	Notes
Center Frequency Accuracy		-60		+60	kHz	1
Output Power	P_O	-3	0	+4	dBm	2,3
Output Power Control Range			65		dB	2,3,7
Harmonic Emissions	P_H		-55	-47	dBc	2
Frequency Deviation	F_{DEV}					
TXM-916-ES		80		130	kHz	5
TXM-868-ES		70		130	kHz	5
Data Rate		200		56,000	bps	7
Analog/Audio Bandwidth		20		28,000	Hz	6,7
Data Input						
Logic Low	V_{IL}	0.0		0.4	VDC	8
Logic High	V_{IH}	3.0		5.2	VDC	8
Power-Down Input						
Logic Low		0.0		0.7	VDC	
Logic High		1.5		V_{CC}	VDC	
Analog Input		0.0		5.0	V_{P-P}	9
Antenna Port						
RF Output Impedance	R_{OUT}		50		Ω	7
Timing						
Transmitter Turn-On Time		0.1	0.5	1.5	ms	7,10
Max. Time Between Transitions				5.0	ms	7,11
Environmental						
Operating Temperature Range		0		+70	°C	7

- Center frequency measured while modulated with a 0-5V square wave
- Into a 50-ohm load
- LADJ open
- Maximum power when LADJ open, minimum power when LADJ grounded
- DATA pin modulated with a 0-5V square wave
- The audio bandwidth is wide to accommodate the needs of the data slicer
- Characterized, but not tested
- The ES is optimized for both 0-5V and 0-3V modulation when sending digital data
- Analog signals, including audio, should be AC-coupled
- Time to transmitter readiness from the application of power to V_{CC} or PDN going high
- Maximum time without a data transition

Figure 4: Electrical Specifications

Typical Performance Graphs

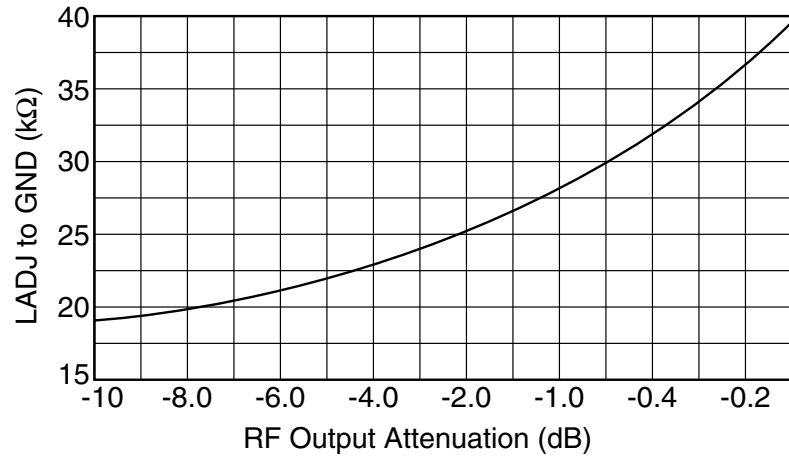

Figure 5: Level Adjust Attenuation

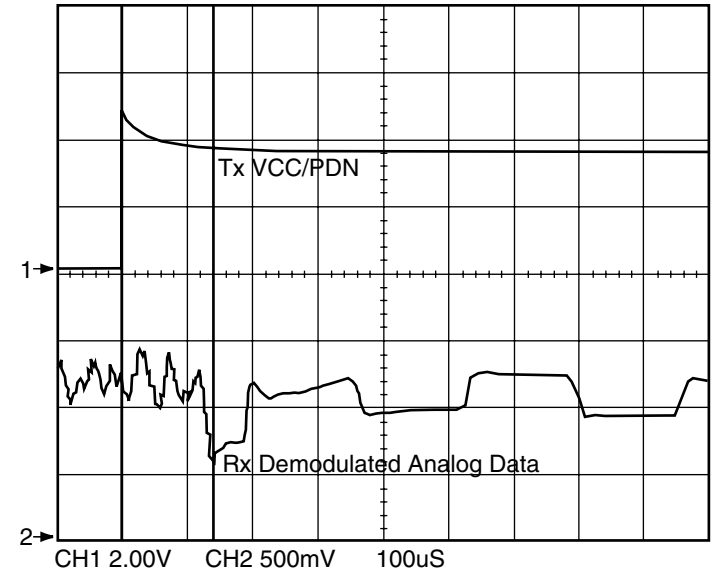

Figure 7: Tx Powerup to Valid Rx Analog

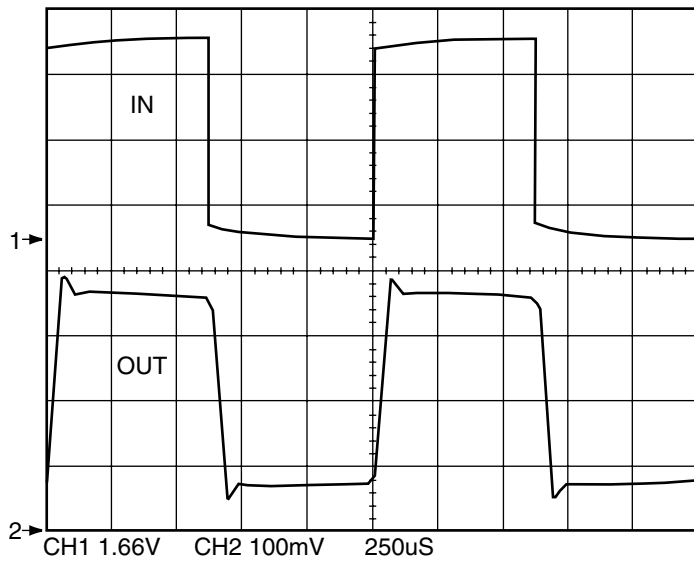

Figure 6: Square-Wave Modulation Linearity

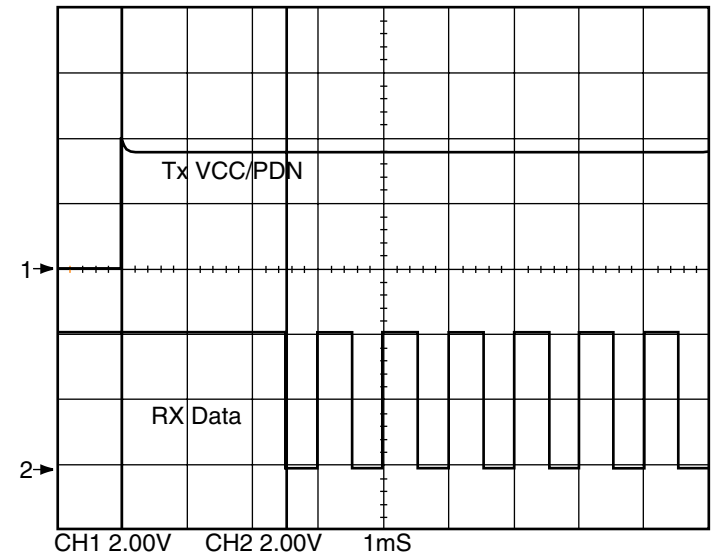

Figure 8: Tx Powerup to Valid Rx Data

Pin Assignments

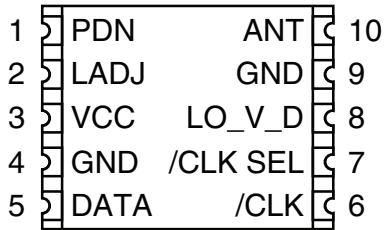

Figure 9: ES Series Transmitter Pinout (Top View)

Pin Descriptions

Pin Descriptions			
Pin Number	Name	I/O	Description
1	PDN	I	Power Down. Pulling this line low places the transmitter into a low-current state. The module is not able to transmit a signal in this state.
2	LADJ	I	Level Adjust. This line can be used to adjust the output power level of the transmitter. Connecting to V_{CC} gives the highest output, while placing a resistor to GND lowers the output level (see Figure 5 on page 4).
3	V_{CC}	—	Supply Voltage
4	GND	—	Analog Ground
5	DATA	O	Analog or Digital Data Input
6	/CLK	O	Divided Clock Output
7	/CLK SEL	O	Clock Frequency Selection. Logic low selects divide by 256, logic high selects divide by 1,024.
8	LO_V_D	O	Low Voltage Detect. This line goes low when V_{CC} is less than 2.15V.
9	GND	—	Analog Ground
10	ANT	—	50-ohm RF Output

Figure 10: ES Series Transmitter Pin Descriptions

Module Description

The TXM-***-ES module is a single-channel transmitter designed for the wireless transfer of digital or analog information over distances of up to 1,000 feet outdoors and up to 500 feet indoors. It is based on a high-performance synthesized architecture. FM / FSK modulation is utilized to provide superior performance and noise immunity over AM-based solutions. The ES Series is incredibly compact and cost-effective when compared with other FM / FSK devices. Best of all, it is packed with many useful features and capabilities that offer a great deal of application flexibility to the designer. Some of these features are:

/CLK Output (use for an external micro-controller)

LO_V_DET (low-voltage detection)

LADJ (adjust the RF output power)

The ES Series is offered in the 902 to 928MHz band, which is free from the legal restrictions of the lower 260 to 470MHz band. This gives the designer much more freedom in the types of applications that can be designed. The 869.85MHz version allows for the same freedom of design in European applications.

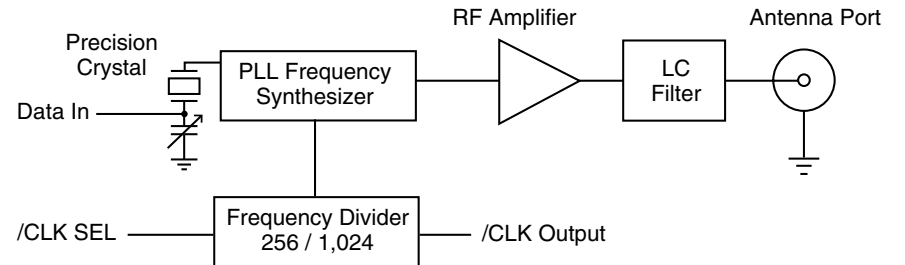

Figure 11: ES Series Transmitter Block Diagram

Theory of Operation

The ES Series FM / FSK transmitter is capable of generating 1mW of output power into a 50-ohm load while suppressing harmonics and spurious emissions to within legal limits. The transmitter is comprised of a VCO and a crystal-controlled frequency synthesizer. The frequency synthesizer, referenced to a precision crystal, locks the VCO to achieve a high-Q, low phase-noise oscillator.

The transmitter operates by directly modulating the crystal with the baseband signal present on the DATA line. Pulling the crystal in this manner achieves the desired deviation and linearity. If the transmitter's VCO were modulated, the frequency synthesizer would track out much of the deviation within the bandwidth of the loop filter (this is a common limitation of most synthesized FM transmitters). The carrier is then amplified and filtered before being output on the 50-ohm ANT line.

The frequency of the Divided Clock output is determined by the state of the Clock Frequency Selection line. A low on the Select line generates a signal on the clock output that is the center frequency divided by 256, a high will be the center frequency divided by 1,024.

Using the Divided Clock Output (/CLK)

When the ES is used with a microcontroller, the divided clock output (/CLK) saves cost and space by eliminating the need for a crystal or other frequency reference for the microprocessor. This line is an open collector output, so an external pull-up resistor (R_L) should be connected between this line and the positive supply voltage. The value of R_L is calculated using two factors.

1. Determine the clock frequency (f_{CLKOUT}). If /CLK SE is open, the /CLK output is the TX center frequency (in MHz) divided by 1,024; if /CLK SEL is grounded, it is divided by 256.
2. Determine the load capacitance of the PCB plus the microcontroller's input capacitance (C_{LD} in pF).

Using these two factors, the value of R_L is calculated:

$$\text{"}/256\text{" } R_L = 1000 / (f_{CLKOUT} * 8 * C_{LD})$$

$$\text{"}/1024\text{" } R_L = 1000 / (f_{CLKOUT} * 8 * C_{LD})$$

Example:

For /256: $1000 / ((916.48 / 256) \times 8 \times 5) = 6.98k\Omega$

Example:

For /1024: $1000 / ((916.48 / 1024) \times 8 \times 5) = 27.9k\Omega$

Using LADJ

The transmitter's output power can be externally adjusted by approximately 65dBm using the LADJ line. This eliminates the need for external attenuation and allows the transmitter's power to be easily adjusted for range control, lower power consumption, or to meet legal requirements.

When the LADJ line is open, the output power is at its maximum and the transmitter draws 7mA typically. When LADJ is at 0V, the output power is at its minimum and the transmitter draws 3mA typically.

The transmit power is set to a particular level by placing a resistor from the LADJ line to ground. This resistor works in combination with an internal supply pull-up to create a voltage divider. This voltage level sets the power amplifier's gain and the output power. Figure 5 shows typical resistor values and corresponding attenuation levels.

The LADJ line is very useful during FCC testing to compensate for antenna gain or other product-specific issues that may cause the output power to exceed legal limits. Often it is wise to connect the LADJ line to a variable resistor so that the test lab can precisely adjust the output power to the maximum threshold allowed by law. The resistor's value can then be noted and a fixed resistor substituted for final testing. Even in designs where attenuation is not anticipated, it is a good idea to place a resistor pad connected to LADJ so that it can be used if needed.

For more sophisticated designs, LADJ may also be controlled by a DAC or digital potentiometer to allow precise and digitally variable output power control.

In any case where the voltage on the LADJ line may fall below 1.5VDC, a low value ceramic capacitor (200 to 4,700pF) must be placed from the module's power supply to the LADJ pin. This is necessary to meet the module's minimum enable voltage at start-up.

Using the PDN Line

The Power Down (PDN) line can be used to power down the transmitter without the need for an external switch. This line has an internal pull-up, so the module is active when it is held high or simply left floating.

When the PDN line is pulled to ground, the transmitter enters into a low current (<95 μ A) power-down mode. During this time, the transmitter is off and cannot perform any function. The startup time coming out of power-down is the same as applying V_{CC} .

The PDN line allows easy control of the transmitter state from external components, such as a microcontroller. By periodically activating the transmitter, sending data, then powering down, the transmitter's average current consumption can be greatly reduced, saving power in battery operated applications.

Using the LO_V_D Line

In many instances, the transmitter may be employed in a battery-powered device. In such applications, it is often useful to be able to sense a low-battery condition, either to signal the need for battery replacement or to power down components that might otherwise operate unpredictably. Normally, this supervisory function would require additional circuitry, but the ES Series transmitter includes the function on-board.

The Low Voltage Detect line (LO_V_D) transitions low when the supply voltage to the transmitter falls below a typical threshold of 2.15VDC. This output can be tied directly to the module's PDN line to shut off the transmitter, or used to indicate the low voltage condition to an external circuit or microprocessor. The output could also be used to provide a visual indication of the low power condition via an LED, although a buffer transistor would generally be required to provide an adequate drive level.

The output can also be monitored in applications with a power supply as a safeguard against brownout conditions.

Typical Applications

Using the ES Series Transmitter for Analog Applications

The ES Series is an excellent choice for sending analog information, including audio. The ability of the ES to transmit combinations of analog and digital content opens many new opportunities for design creativity.

Simple or complex analog signals within the specified audio bandwidth and input levels may be connected directly to the transmitter's DATA line. The transmitter input is high impedance (500k Ω) and can be directly driven by a wide variety of sources, ranging from a single frequency to complex content, such as audio.

Analog sources should provide 0V to no more than 5V_{p-p} maximum waveform and should be AC-coupled into the DATA line. The size of the coupling capacitor should be large enough to ensure the passage of all desired frequencies. Since the modulation voltage applied to the DATA line determines the carrier deviation, distortion can occur if the DATA line is over-driven. The actual level of the input waveform should be adjusted to achieve optimum in-circuit results.

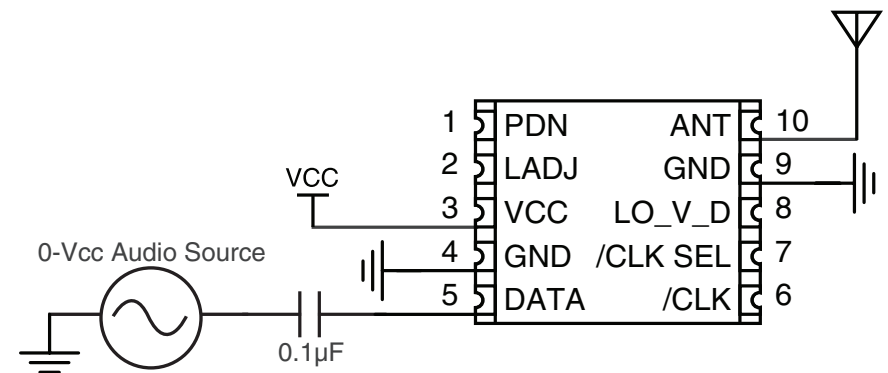

Figure 12: AC Coupling An Audio Source to the ES Series Transmitter

Using the ES Series Transmitter for Digital Applications

The ES Series transmitter is equally capable at accommodating digital data. The transmitter's input is high impedance (500k) and can be directly driven by a wide variety of sources including microprocessors and encoder ICs.

When the transmitter will be used to transmit digital data, the DATA line is best driven from a 3 to 5V source. The transmitter is designed to give an average deviation of 115kHz with a 5V square wave input, and 75kHz with 3V square wave input. Either choice will achieve maximum performance.

Data adhering to different electrical level standards, such as RS-232, will require buffering or conversion to logic level voltages. In the case of RS-232, such buffering is easily handled with widely available ICs, such as the MAX232, which is used on the ES Series Master Development System. The Linx SDM-USB-QS can be used to convert between USB compliant signals and logic level voltages.

Note: The RS-232 protocol is not a robust protocol for the noisy RF environment. It can be used for very short range links, but is subject to interference and does not contain any error detection or correction. Please see the Protocol Guidelines section for more information.

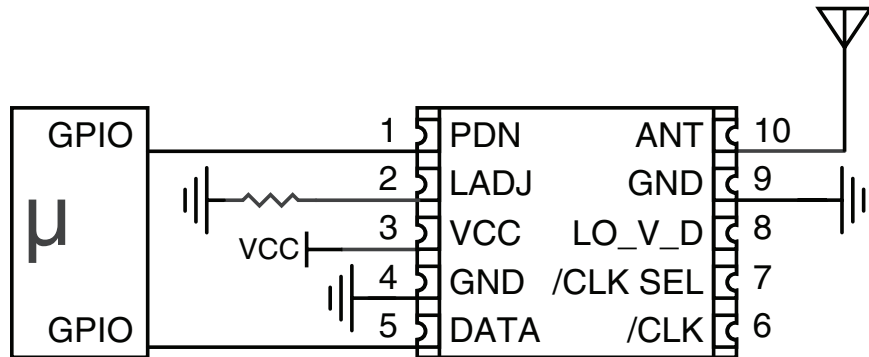

Figure 13: ES Series Transmitter Typical Application Circuit

ESD Concerns

The module has basic ESD protection built in, but in cases where the antenna connection is exposed to the user it is a good idea to add additional protection. A Transient Voltage Suppressor (TVS) diode, varistor or similar component can be added to the antenna line. These should have low capacitance and be designed for use on antennas. Protection on the supply line is a good idea in designs that have a user-accessible power port.

Power Supply Requirements

The module does not have an internal voltage regulator; therefore it requires a clean, well-regulated power source. While it is preferable to power the unit from a battery, it can also be operated from a power supply as long as noise is less than 20mV. Power supply noise can affect the transmitter modulation; therefore, providing a clean power supply for the module should be a high priority during design.

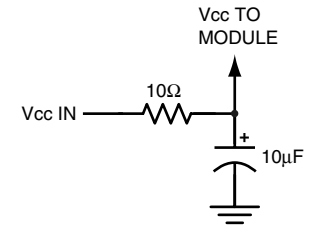

Figure 14: Supply Filter

A 10Ω resistor in series with the supply followed by a 10μF tantalum capacitor from VCC to ground will help in cases where the quality of supply power is poor. Note that operation from 4.3 to 5.2 volts requires the use of an external 270Ω resistor placed in series with the supply to prevent V_{CC} from exceeding 4.0 volts, so the dropping resistor can take the place of the 10Ω resistor in the supply filter. These values may need to be adjusted depending on the noise present on the supply line.

Protocol Guidelines

While many RF solutions impose data formatting and balancing requirements, Linx RF modules do not encode or packetize the signal content in any manner. The received signal will be affected by such factors as noise, edge jitter, and interference, but it is not purposefully manipulated or altered by the modules. This gives the designer tremendous flexibility for protocol design and interface.

Despite this transparency and ease of use, it must be recognized that there are distinct differences between a wired and a wireless environment. Issues such as interference and contention must be understood and allowed for in the design process. To learn more about protocol considerations, we suggest you read Linx Application Note AN-00160.

Errors from interference or changing signal conditions can cause corruption of the data packet, so it is generally wise to structure the data being sent into small packets. This allows errors to be managed without affecting large amounts of data. A simple checksum or CRC could be used for basic error detection. Once an error is detected, the protocol designer may wish to simply discard the corrupt data or implement a more sophisticated scheme to correct it.

Interference Considerations

The RF spectrum is crowded and the potential for conflict with unwanted sources of RF is very real. While all RF products are at risk from interference, its effects can be minimized by better understanding its characteristics.

Interference may come from internal or external sources. The first step is to eliminate interference from noise sources on the board. This means paying careful attention to layout, grounding, filtering and bypassing in order to eliminate all radiated and conducted interference paths. For many products, this is straightforward; however, products containing components such as switching power supplies, motors, crystals and other potential sources of noise must be approached with care. Comparing your own design with a Linx evaluation board can help to determine if and at what level design-specific interference is present.

External interference can manifest itself in a variety of ways. Low-level interference produces noise and hashing on the output and reduces the link's overall range.

High-level interference is caused by nearby products sharing the same frequency or from near-band high-power devices. It can even come from your own products if more than one transmitter is active in the same area. It is important to remember that only one transmitter at a time can occupy a frequency, regardless of the coding of the transmitted signal. This type of interference is less common than those mentioned previously, but in severe cases it can prevent all useful function of the affected device.

Although technically not interference, multipath is also a factor to be understood. Multipath is a term used to refer to the signal cancellation effects that occur when RF waves arrive at the receiver in different phase relationships. This effect is a particularly significant factor in interior environments where objects provide many different signal reflection paths. Multipath cancellation results in lowered signal levels at the receiver and shorter useful distances for the link.

Pad Layout

The pad layout diagram in Figure 15 is designed to facilitate both hand and automated assembly.

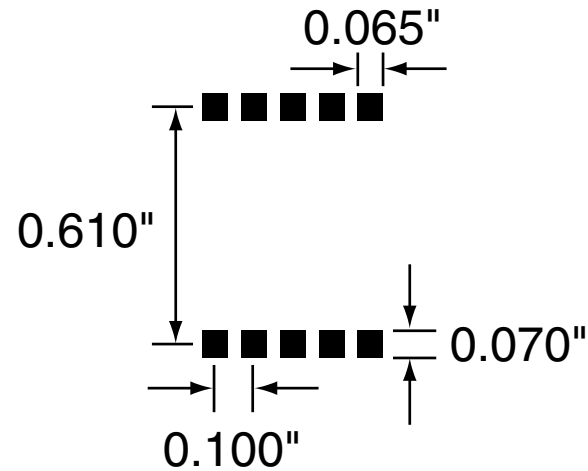

Figure 15: Recommended PCB Layout

Board Layout Guidelines

The module's design makes integration straightforward; however, it is still critical to exercise care in PCB layout. Failure to observe good layout techniques can result in a significant degradation of the module's performance. A primary layout goal is to maintain a characteristic 50-ohm impedance throughout the path from the antenna to the module. Grounding, filtering, decoupling, routing and PCB stack-up are also important considerations for any RF design. The following section provides some basic design guidelines.

During prototyping, the module should be soldered to a properly laid-out circuit board. The use of prototyping or "perf" boards results in poor performance and is strongly discouraged. Likewise, the use of sockets can have a negative impact on the performance of the module and is discouraged.

The module should, as much as reasonably possible, be isolated from other components on your PCB, especially high-frequency circuitry such as crystal oscillators, switching power supplies, and high-speed bus lines.

When possible, separate RF and digital circuits into different PCB regions.

Make sure internal wiring is routed away from the module and antenna and is secured to prevent displacement.

Do not route PCB traces directly under the module. There should not be any copper or traces under the module on the same layer as the module, just bare PCB. The underside of the module has traces and vias that could short or couple to traces on the product's circuit board.

The Pad Layout section shows a typical PCB footprint for the module. A ground plane (as large and uninterrupted as possible) should be placed on a lower layer of your PCB opposite the module. This plane is essential for creating a low impedance return for ground and consistent stripline performance.

Use care in routing the RF trace between the module and the antenna or connector. Keep the trace as short as possible. Do not pass it under the module or any other component. Do not route the antenna trace on multiple PCB layers as vias add inductance. Vias are acceptable for tying together ground layers and component grounds and should be used in multiples.

Each of the module's ground pins should have short traces tying immediately to the ground plane through a via.

Bypass caps should be low ESR ceramic types and located directly adjacent to the pin they are serving.

A 50-ohm coax should be used for connection to an external antenna. A 50-ohm transmission line, such as a microstrip, stripline or coplanar waveguide should be used for routing RF on the PCB. The Microstrip Details section provides additional information.

In some instances, a designer may wish to encapsulate or "pot" the product. There are a wide variety of potting compounds with varying dielectric properties. Since such compounds can considerably impact RF performance and the ability to rework or service the product, it is the responsibility of the designer to evaluate and qualify the impact and suitability of such materials.

Microstrip Details

A transmission line is a medium whereby RF energy is transferred from one place to another with minimal loss. This is a critical factor, especially in high-frequency products like Linx RF modules, because the trace leading to the module's antenna can effectively contribute to the length of the antenna, changing its resonant bandwidth. In order to minimize loss and detuning, some form of transmission line between the antenna and the module should be used unless the antenna can be placed very close (<1/8in) to the module. One common form of transmission line is a coax cable and another is the microstrip. This term refers to a PCB trace running over a ground plane that is designed to serve as a transmission line between the module and the antenna. The width is based on the desired characteristic impedance of the line, the thickness of the PCB and the dielectric constant of the board material. For standard 0.062in thick FR-4 board material, the trace width would be 111 mils. The correct trace width can be calculated for other widths and materials using the information in Figure 16 and examples are provided in Figure 17. Software for calculating microstrip lines is also available on the Linx website.

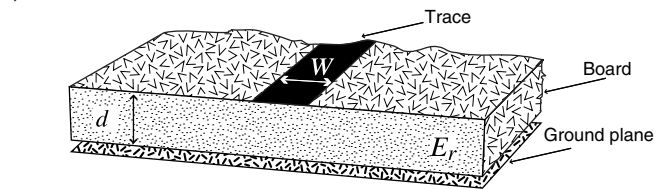

$$E_e = \frac{E_r + 1}{2} + \frac{E_r - 1}{2} \cdot \frac{1}{\sqrt{1 + 12d/W}}$$

$$Z_0 = \begin{cases} \frac{60}{\sqrt{E_e}} \cdot \ln\left(\frac{8d}{W} + \frac{W}{4d}\right) & \text{For } \frac{W}{d} \leq 1 \\ \frac{120\pi}{\sqrt{E_e} \cdot \left(\frac{W}{d} + 1.393 + 0.667 \cdot \ln\left(\frac{W}{d} + 1.444\right)\right)} & \text{For } \frac{W}{d} \geq 1 \end{cases}$$

E_r = Dielectric constant of PCB material

Figure 16: Microstrip Formulas

Example Microstrip Calculations			
Dielectric Constant	Width / Height Ratio (W / d)	Effective Dielectric Constant	Characteristic Impedance (Ω)
4.80	1.8	3.59	50.0
4.00	2.0	3.07	51.0
2.55	3.0	2.12	48.8

Figure 17: Example Microstrip Calculations

Production Guidelines

The module is housed in a hybrid SMD package that supports hand and automated assembly techniques. Since the modules contain discrete components internally, the assembly procedures are critical to ensuring the reliable function of the modules. The following procedures should be reviewed with and practiced by all assembly personnel.

Hand Assembly

Pads located on the bottom of the module are the primary mounting surface (Figure 18). Since these pads are inaccessible during mounting, castellations that run up the side of the module have been provided to facilitate solder wicking to the module's underside. This allows for very

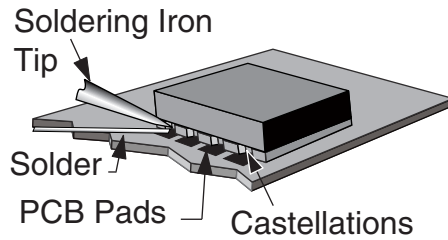

Figure 18: Soldering Technique

quick hand soldering for prototyping and small volume production. If the recommended pad guidelines have been followed, the pads will protrude slightly past the edge of the module. Use a fine soldering tip to heat the board pad and the castellation, then introduce solder to the pad at the module's edge. The solder will wick underneath the module, providing reliable attachment. Tack one module corner first and then work around the device, taking care not to exceed the times in Figure 19.

Warning: Pay attention to the absolute maximum solder times.

Absolute Maximum Solder Times

Hand Solder Temperature: +225°C for 10 seconds

Recommended Solder Melting Point: +180°C

Reflow Oven: +255°C max (see Figure Figure 20)

Figure 19: Absolute Maximum Solder Times

Automated Assembly

For high-volume assembly, the modules are generally auto-placed. The modules have been designed to maintain compatibility with reflow processing techniques; however, due to their hybrid nature, certain aspects of the assembly process are far more critical than for other component types. Following are brief discussions of the three primary areas where caution must be observed.

Reflow Temperature Profile

The single most critical stage in the automated assembly process is the reflow stage. The reflow profile in Figure 20 should not be exceeded because excessive temperatures or transport times during reflow will irreparably damage the modules. Assembly personnel need to pay careful attention to the oven's profile to ensure that it meets the requirements necessary to successfully reflow all components while still remaining within the limits mandated by the modules. The figure below shows the recommended reflow oven profile for the modules.

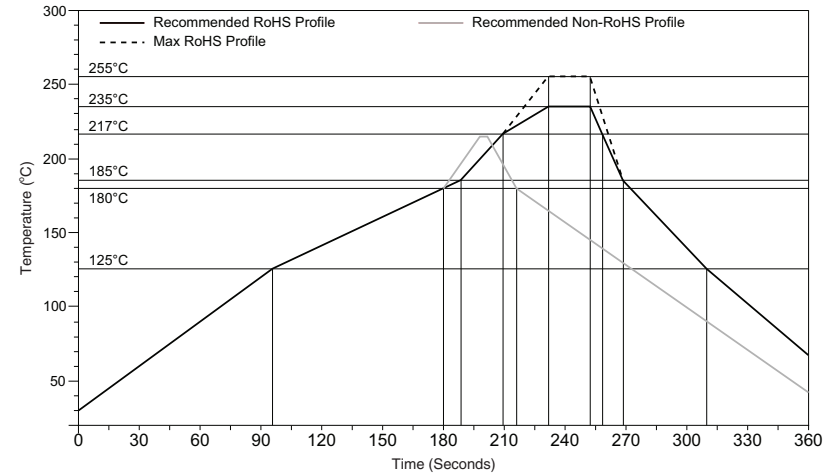

Figure 20: Maximum Reflow Temperature Profile

Shock During Reflow Transport

Since some internal module components may reflow along with the components placed on the board being assembled, it is imperative that the modules not be subjected to shock or vibration during the time solder is liquid. Should a shock be applied, some internal components could be lifted from their pads, causing the module to not function properly.

Washability

The modules are wash-resistant, but are not hermetically sealed. Linx recommends wash-free manufacturing; however, the modules can be subjected to a wash cycle provided that a drying time is allowed prior to applying electrical power to the modules. The drying time should be sufficient to allow any moisture that may have migrated into the module to evaporate, thus eliminating the potential for shorting damage during power-up or testing. If the wash contains contaminants, the performance may be adversely affected, even after drying.

Helpful Application Notes From Linx

It is not the intention of this manual to address in depth many of the issues that should be considered to ensure that the modules function correctly and deliver the maximum possible performance. As you proceed with your design, you may wish to obtain one or more of the following application notes which address in depth key areas of RF design and application of Linx products. These application notes are available online at www.linxtechnologies.com or by contacting Linx.

Helpful Application Note Titles	
Note Number	Note Title
AN-00100	RF 101: Information for the RF Challenged
AN-00126	Considerations for Operation Within the 902–928MHz Band
AN-00130	Modulation Techniques for Low-Cost RF Data Links
AN-00140	The FCC Road: Part 15 from Concept to Approval
AN-00160	Considerations for Sending Data over a Wireless Link
AN-00500	Antennas: Design, Application, Performance
AN-00501	Understanding Antenna Specifications and Operation

Figure 21: Helpful Application Note Titles

Antenna Considerations

The choice of antennas is a critical and often overlooked design consideration. The range, performance, and legality of an RF link are critically dependent upon the antenna. While adequate antenna performance can often be obtained by trial and error methods, antenna design and matching is a complex task. A professionally designed antenna, such as those from Linx, will help ensure maximum performance and FCC compliance.



Figure 22: Linx Antennas

Linx transmitter modules typically have an output power that is slightly higher than the legal limits. This allows the designer to use an inefficient antenna, such as a loop trace or helical, to meet size, cost, or cosmetic requirements and still achieve full legal output power for maximum range. If an efficient antenna is used, then some attenuation of the output power will likely be needed. This can easily be accomplished by using the LADJ line or a T-pad attenuator. For more details on T-pad attenuator design, please see Application Note AN-00150.

A receiver antenna should be optimized for the frequency or band in which the receiver operates and to minimize the reception of off-frequency signals. The efficiency of the receiver's antenna is critical to maximizing range performance. Unlike the transmitter antenna, where legal operation may mandate attenuation or a reduction in antenna efficiency, the receiver's antenna should be optimized as much as is practical.

It is usually best to utilize a basic quarter-wave whip until your prototype product is operating satisfactorily. Other antennas can then be evaluated based on the cost, size, and cosmetic requirements of the product. You may wish to review Application Note AN-00500 "Antennas: Design, Application, Performance"

General Antenna Rules

The following general rules should help in maximizing antenna performance.

1. Proximity to objects such as a user's hand, body or metal objects will cause an antenna to detune. For this reason, the antenna shaft and tip should be positioned as far away from such objects as possible.
2. Optimum performance is obtained from a $\frac{1}{4}$ - or $\frac{1}{2}$ -wave straight whip mounted at a right angle to the ground plane (Figure 23). In many cases, this isn't desirable for practical or ergonomic reasons, thus, an alternative antenna style such as a helical, loop or patch may be utilized and the corresponding sacrifice in performance accepted.

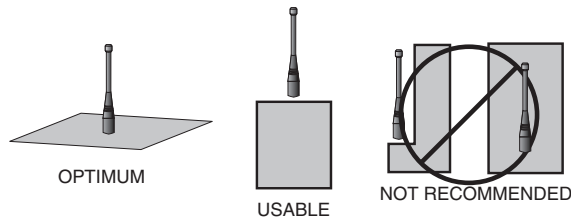

Figure 23: Ground Plane Orientation

3. If an internal antenna is to be used, keep it away from other metal components, particularly large items like transformers, batteries, PCB tracks and ground planes. In many cases, the space around the antenna is as important as the antenna itself. Objects in close proximity to the antenna can cause direct detuning, while those farther away will alter the antenna's symmetry.
4. In many antenna designs, particularly $\frac{1}{4}$ -wave whips, the ground plane acts as a counterpoise, forming, in essence, a $\frac{1}{2}$ -wave dipole (Figure 24). For this reason, adequate ground plane area is essential. The ground plane can be a metal case or ground-fill areas on a circuit board. Ideally, it should have a surface area less than or equal to the overall length of the $\frac{1}{4}$ -wave radiating element. This is often not practical due to size and configuration constraints. In these instances, a designer must make the best use of the area available to create as much ground

VERTICAL $\lambda/4$ GROUNDED ANTENNA (MARCONI)

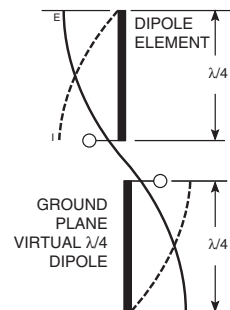

Figure 24: Dipole Antenna

plane as possible in proximity to the base of the antenna. In cases where the antenna is remotely located or the antenna is not in close proximity to a circuit board, ground plane or grounded metal case, a metal plate may be used to maximize the antenna's performance.

5. Remove the antenna as far as possible from potential interference sources. Any frequency of sufficient amplitude to enter the receiver's front end will reduce system range and can even prevent reception entirely. Switching power supplies, oscillators or even relays can also be significant sources of potential interference. The single best weapon against such problems is attention to placement and layout. Filter the module's power supply with a high-frequency bypass capacitor. Place adequate ground plane under potential sources of noise to shunt noise to ground and prevent it from coupling to the RF stage. Shield noisy board areas whenever practical.
6. In some applications, it is advantageous to place the module and antenna away from the main equipment (Figure 25). This can avoid interference problems and allows the antenna to be oriented for optimum performance. Always use 50Ω coax, like RG-174, for the remote feed.

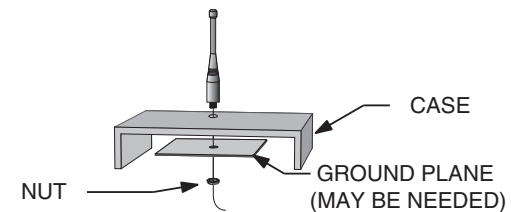

Figure 25: Remote Ground Plane

Common Antenna Styles

There are hundreds of antenna styles and variations that can be employed with Linx RF modules. Following is a brief discussion of the styles most commonly utilized. Additional antenna information can be found in Linx Application Notes AN-00100, AN-00140, AN-00500 and AN-00501. Linx antennas and connectors offer outstanding performance at a low price.

Whip Style

A whip style antenna (Figure 26) provides outstanding overall performance and stability. A low-cost whip can be easily fabricated from a wire or rod, but most designers opt for the consistent performance and cosmetic appeal of a professionally-made model. To meet this need, Linx offers a wide variety of straight and reduced height whip style antennas in permanent and connectorized mounting styles.



Figure 26: Whip Style Antennas

The wavelength of the operational frequency determines an antenna's overall length. Since a full wavelength is often quite long, a partial 1/2- or 1/4-wave antenna is normally employed. Its size and natural radiation resistance make it well matched to Linx modules. The proper length for a straight 1/4-wave can be easily determined using the formula in Figure 27. It is also possible to reduce the overall height of the antenna by using a helical winding. This reduces the antenna's bandwidth but is a great way to minimize the antenna's physical size for compact applications. This also means that the physical appearance is not always an indicator of the antenna's frequency.

$$L = \frac{234}{F_{\text{MHz}}}$$

Figure 27:
L = length in feet of quarter-wave length
F = operating frequency in megahertz

Specialty Styles

Linx offers a wide variety of specialized antenna styles (Figure 28). Many of these styles utilize helical elements to reduce the overall antenna size while maintaining reasonable performance. A helical antenna's bandwidth is often quite narrow and the antenna can detune in proximity to other objects, so care must be exercised in layout and placement.



Figure 28: Specialty Style Antennas

Loop Style

A loop or trace style antenna is normally printed directly on a product's PCB (Figure 29). This makes it the most cost-effective of antenna styles. The element can be made self-resonant or externally resonated with discrete components, but its actual layout is usually product specific. Despite the cost advantages, loop style antennas are generally inefficient and useful only for short range applications. They are also very sensitive to changes in layout and PCB dielectric, which can cause consistency issues during production. In addition, printed styles are difficult to engineer, requiring the use of expensive equipment including a network analyzer. An improperly designed loop will have a high VSWR at the desired frequency which can cause instability in the RF stage.



Figure 29: Loop or Trace Antenna

Linx offers low-cost planar (Figure 30) and chip antennas that mount directly to a product's PCB. These tiny antennas do not require testing and provide excellent performance despite their small size. They offer a preferable alternative to the often problematic "printed" antenna.



Figure 30: SP Series "Splatch" and uSP "MicroSplatch" Antennas

Regulatory Considerations

Note: Linx RF modules are designed as component devices that require external components to function. The purchaser understands that additional approvals may be required prior to the sale or operation of the device, and agrees to utilize the component in keeping with all laws governing its use in the country of operation.

When working with RF, a clear distinction must be made between what is technically possible and what is legally acceptable in the country where operation is intended. Many manufacturers have avoided incorporating RF into their products as a result of uncertainty and even fear of the approval and certification process. Here at Linx, our desire is not only to expedite the design process, but also to assist you in achieving a clear idea of what is involved in obtaining the necessary approvals to legally market a completed product.

For information about regulatory approval, read AN-00142 on the Linx website or call Linx. Linx designs products with worldwide regulatory approval in mind.

In the United States, the approval process is actually quite straightforward. The regulations governing RF devices and the enforcement of them are the responsibility of the Federal Communications Commission (FCC). The regulations are contained in Title 47 of the United States Code of Federal Regulations (CFR). Title 47 is made up of numerous volumes; however, all regulations applicable to this module are contained in Volume 0-19. It is strongly recommended that a copy be obtained from the FCC's website, the Government Printing Office in Washington or from your local government bookstore. Excerpts of applicable sections are included with Linx evaluation kits or may be obtained from the Linx Technologies website, www.linxtechnologies.com. In brief, these rules require that any device that intentionally radiates RF energy be approved, that is, tested for compliance and issued a unique identification number. This is a relatively painless process. Final compliance testing is performed by one of the many independent testing laboratories across the country. Many labs can also provide other certifications that the product may require at the same time, such as UL, CLASS A / B, etc. Once the completed product has passed, an ID number is issued that is to be clearly placed on each product manufactured.

Questions regarding interpretations of the Part 2 and Part 15 rules or the measurement procedures used to test intentional radiators such as Linx RF modules for compliance with the technical standards of Part 15 should be addressed to:

Federal Communications Commission
Equipment Authorization Division
Customer Service Branch, MS 1300F2
7435 Oakland Mills Road
Columbia, MD, US 21046
Phone: + 1 301 725 585 | Fax: + 1 301 344 2050
Email: labinfo@fcc.gov

ETSI Secretaria
650, Route des Lucioles
06921 Sophia-Antipolis Cedex
FRANCE
Phone: +33 (0)4 92 94 42 00
Fax: +33 (0)4 93 65 47 16

International approvals are slightly more complex, although Linx modules are designed to allow all international standards to be met. If the end product is to be exported to other countries, contact Linx to determine the specific suitability of the module to the application.

All Linx modules are designed with the approval process in mind and thus much of the frustration that is typically experienced with a discrete design is eliminated. Approval is still dependent on many factors, such as the choice of antennas, correct use of the frequency selected and physical packaging. While some extra cost and design effort are required to address these issues, the additional usefulness and profitability added to a product by RF makes the effort more than worthwhile.



Linx Technologies
159 Ort Lane
Merlin, OR, US 97532

Phone: +1 541 471 6256
Fax: +1 541 471 6251

www.linxtechnologies.com

Disclaimer

Linx Technologies is continually striving to improve the quality and function of its products. For this reason, we reserve the right to make changes to our products without notice. The information contained in this Data Guide is believed to be accurate as of the time of publication. Specifications are based on representative lot samples. Values may vary from lot-to-lot and are not guaranteed. "Typical" parameters can and do vary over lots and application. Linx Technologies makes no guarantee, warranty, or representation regarding the suitability of any product for use in any specific application. It is the customer's responsibility to verify the suitability of the part for the intended application. **NO LINX PRODUCT IS INTENDED FOR USE IN ANY APPLICATION WHERE THE SAFETY OF LIFE OR PROPERTY IS AT RISK.**

Linx Technologies **DISCLAIMS ALL WARRANTIES OF MERCHANTABILITY AND FITNESS FOR A PARTICULAR PURPOSE. IN NO EVENT SHALL LINX TECHNOLOGIES BE LIABLE FOR ANY OF CUSTOMER'S INCIDENTAL OR CONSEQUENTIAL DAMAGES ARISING IN ANY WAY FROM ANY DEFECTIVE OR NON-CONFORMING PRODUCTS OR FOR ANY OTHER BREACH OF CONTRACT BY LINX TECHNOLOGIES.** The limitations on Linx Technologies' liability are applicable to any and all claims or theories of recovery asserted by Customer, including, without limitation, breach of contract, breach of warranty, strict liability, or negligence. Customer assumes all liability (including, without limitation, liability for injury to person or property, economic loss, or business interruption) for all claims, including claims from third parties, arising from the use of the Products. The Customer will indemnify, defend, protect, and hold harmless Linx Technologies and its officers, employees, subsidiaries, affiliates, distributors, and representatives from and against all claims, damages, actions, suits, proceedings, demands, assessments, adjustments, costs, and expenses incurred by Linx Technologies as a result of or arising from any Products sold by Linx Technologies to Customer. Under no conditions will Linx Technologies be responsible for losses arising from the use or failure of the device in any application, other than the repair, replacement, or refund limited to the original product purchase price. Devices described in this publication may contain proprietary, patented, or copyrighted techniques, components, or materials. Under no circumstances shall any user be conveyed any license or right to the use or ownership of such items.

©2015 Linx Technologies. All rights reserved.

The stylized Linx logo, Wireless Made Simple, WISE, CipherLinx and the stylized CL logo are trademarks of Linx Technologies.