



Chipsmall Limited consists of a professional team with an average of over 10 year of expertise in the distribution of electronic components. Based in Hongkong, we have already established firm and mutual-benefit business relationships with customers from,Europe,America and south Asia,supplying obsolete and hard-to-find components to meet their specific needs.

With the principle of “Quality Parts,Customers Priority,Honest Operation,and Considerate Service”,our business mainly focus on the distribution of electronic components. Line cards we deal with include Microchip,ALPS,ROHM,Xilinx,Pulse,ON,Everlight and Freescale. Main products comprise IC,Modules,Potentiometer,IC Socket,Relay,Connector.Our parts cover such applications as commercial,industrial, and automotives areas.

We are looking forward to setting up business relationship with you and hope to provide you with the best service and solution. Let us make a better world for our industry!



Contact us

Tel: +86-755-8981 8866 Fax: +86-755-8427 6832

Email & Skype: info@chipsmall.com Web: www.chipsmall.com

Address: A1208, Overseas Decoration Building, #122 Zhenhua RD., Futian, Shenzhen, China



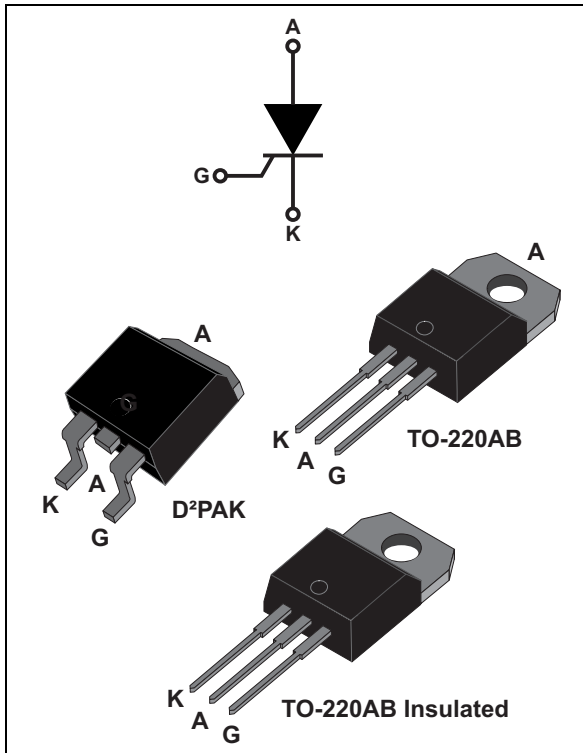

Features

- On-state rms current, $I_{T(RMS)}$ 25 A
- Repetitive peak off-state voltage, V_{DRM}/V_{RRM} 600 to 1200 V
- Triggering gate current, I_{GT} 40 mA
- Insulated package TO-220AB ins
 - Insulating voltage 2500 V rms
 - UL1557 certified (file ref. E81734)

Description

These standard 25 A SCRs are suitable for general purpose applications.

Using clip assembly technology, they provide a superior performance in surge current capabilities.

TXN625RG is packaged in TO-220AB ins.

Table 1. Device summary

Order code	Voltage V_{DRM}/V_{RRM}			Sensitivity I_{GT}	Package
	600 V	800 V	1200 V		
TN2540-600G-TR	Y			40 mA	D ² PAK
TN2540-800G-TR		Y		40 mA	D ² PAK
TXN625RG	Y			40 mA	TO-220AB ins
TYN625RG	Y			40 mA	TO-220AB
TYN825RG		Y		40 mA	TO-220AB
TYN1225RG			Y	40 mA	TO-220AB

1 Characteristics

Table 2. Absolute ratings (limiting values)

Symbol	Parameter		Value	Unit	
$I_{T(RMS)}$	On-state rms current (180 °Conduction angle)	TO-220AB, D ² PAK	$T_c = 100\text{ °C}$	25	A
		TO-220AB ins	$T_c = 83\text{ °C}$		
$I_{T(AV)}$	Average on-state current (180 °Conduction angle)		$T_c = 100\text{ °C}$	16	A
I_{TSM}	Non repetitive surge peak on-state current	$t_p = 8.3\text{ ms}$	$T_j = 25\text{ °C}$	314	A
		$t_p = 10\text{ ms}$		300	
I^2t	I^2t Value for fusing	$t_p = 10\text{ ms}$	$T_j = 25\text{ °C}$	450	A ² s
dI/dt	Critical rate of rise of on-state current $I_G = 2 \times I_{GT}$, $t_r \leq 100\text{ ns}$	F = 60 Hz	$T_j = 125\text{ °C}$	50	A/ μ s
I_{GM}	Peak gate current	$t_p = 20\text{ }\mu$ s	$T_j = 125\text{ °C}$	4	A
$P_{G(AV)}$	Average gate power dissipation		$T_j = 125\text{ °C}$	1	W
T_{stg} T_j	Storage junction temperature range Operating junction temperature range			- 40 to + 150 - 40 to + 125	°C
V_{RGM}	Maximum peak reverse gate voltage			5	V

Table 3. Electrical Characteristics ($T_j = 25\text{ °C}$, unless otherwise specified)

Symbol	Test conditions		Value	Unit		
I_{GT}	$V_D = 12\text{ V}$ $R_L = 33\text{ }\Omega$	MIN.	4	mA		
		MAX.	40			
V_{GT}		MAX.	1.3	V		
V_{GD}	$V_D = V_{DRM}$ $R_L = 3.3\text{ k}\Omega$	$T_j = 125\text{ °C}$	MIN.	0.2	V	
I_H	$I_T = 500\text{ mA}$ Gate open		MAX.	50	mA	
I_L	$I_G = 1.2 \times I_{GT}$		MAX.	90	mA	
dV/dt	$V_D = 67\% V_{DRM}$ Gate open	$T_j = 125\text{ °C}$	MIN.	1500	V/ μ s	
V_{TM}	$I_{TM} = 50\text{ A}$ $t_p = 380\text{ }\mu$ s	$T_j = 25\text{ °C}$	MAX.	1.6	V	
V_{t0}	Threshold voltage		$T_j = 125\text{ °C}$	MAX.	0.77	V
R_d	Dynamic resistance		$T_j = 125\text{ °C}$	MAX.	14	m Ω
I_{DRM} I_{RRM}	$V_{DRM} = V_{RRM}$	$T_j = 25\text{ °C}$	MAX.	5	μ A	
		$T_j = 125\text{ °C}$		4	mA	

Table 4. Thermal resistances

Symbol	Parameter	Value	Unit
$R_{th(j-c)}$	Junction to case (DC)	D ² PAK, TO-220AB	1.0
		TO-220AB ins	2.0
$R_{th(j-a)}$	Junction to ambient (DC)	D ² PAK	45
		TO-220AB, TO-220AB ins	60

1. S = Copper surface under tab.

Figure 1. Maximum average power dissipation versus average on-state current

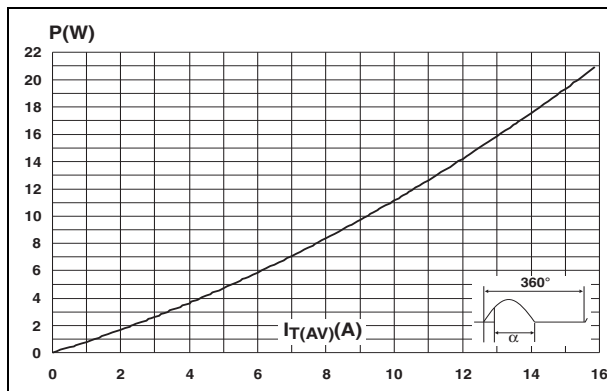

Figure 2. Average and DC on-state current versus case temperature

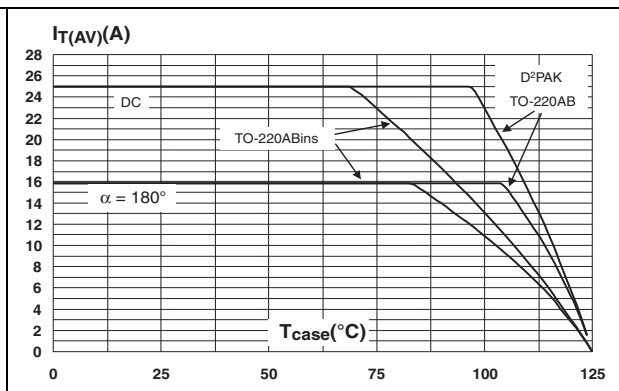

Figure 3. Average and DC on-state current versus ambient temperature

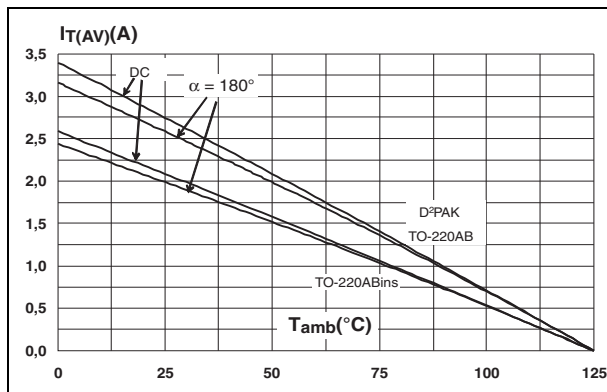

Figure 4. Relative variation of thermal impedance versus pulse duration (D²PAK, and TO-220AB)

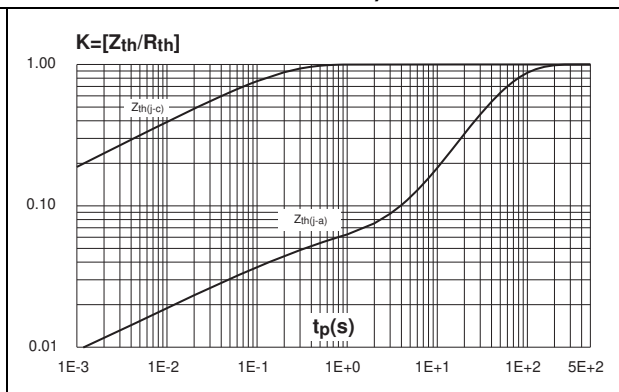

Figure 5. Relative variation of thermal impedance versus pulse duration (TO-220AB ins)

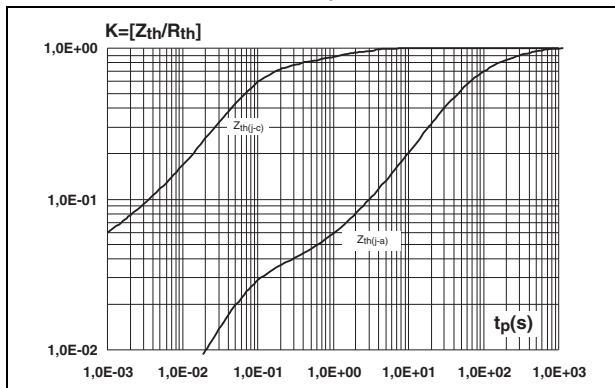

Figure 6. Relative variation of gate trigger, holding, and latching currents versus junction temperature

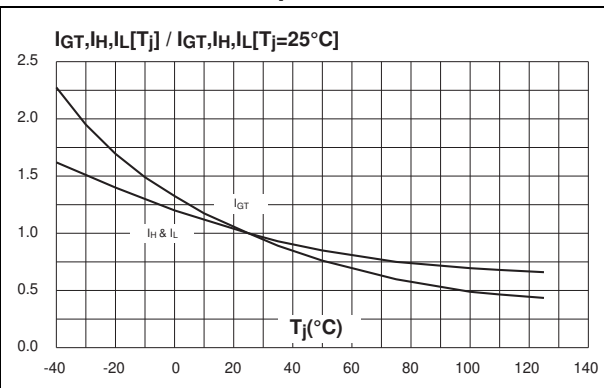

Figure 7. Surge peak on-state current versus number of cycles

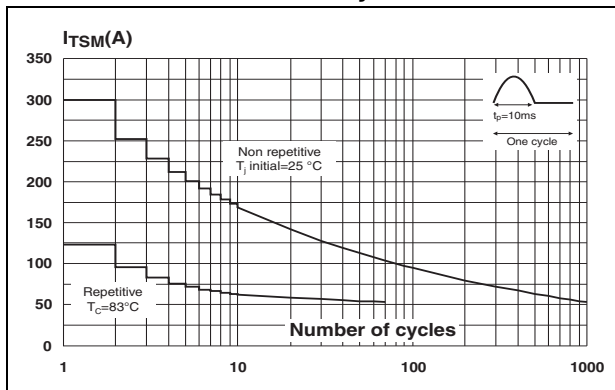

Figure 8. Non-repetitive surge peak on-state current, and corresponding values of I²t

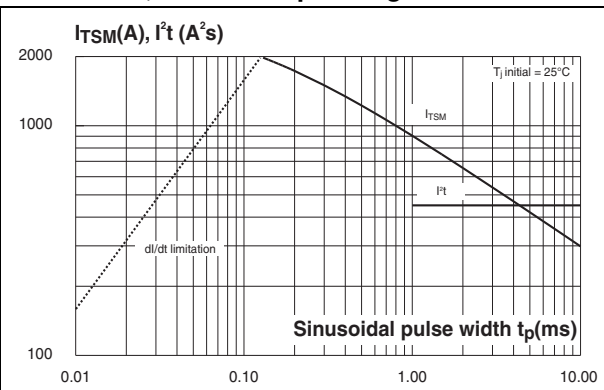

Figure 9. On-state characteristics (maximum values)

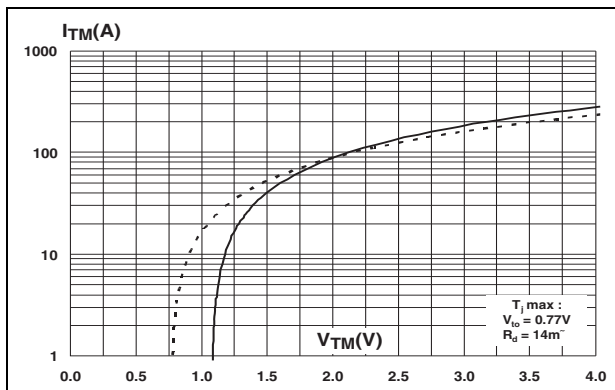
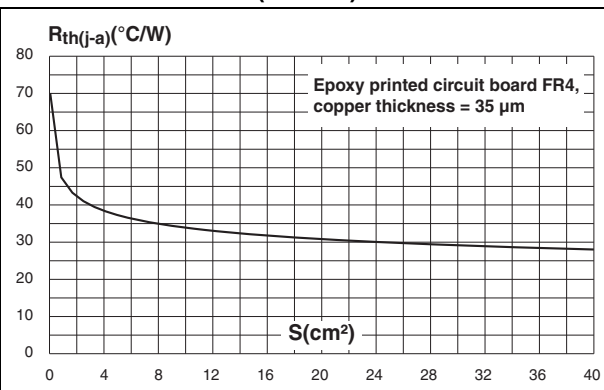

Figure 10. Thermal resistance junction to ambient versus copper surface under tab (D²PAK)



2 Ordering information schemes

Figure 11. TN2540-x00G ordering information scheme

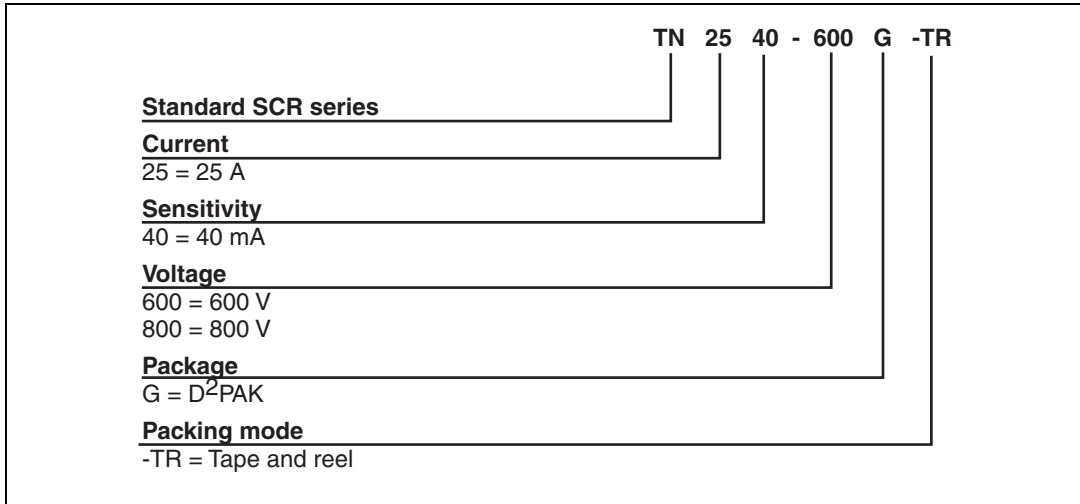

Figure 12. TXN625RG ordering information scheme

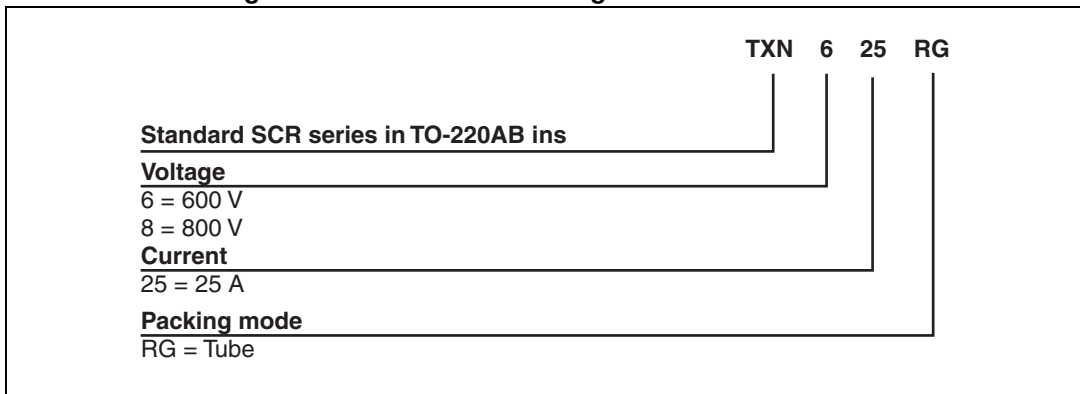
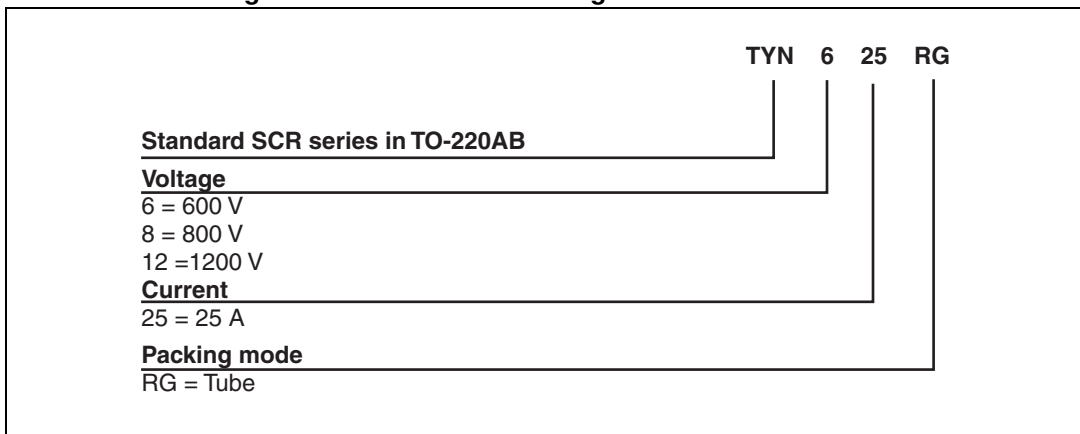

Figure 13. TYNx25RG ordering information scheme



3 Package information

- Epoxy meets UL94, V0
- Lead-free package
- Recommended torque values (TO-220AB, and TO220AB ins): 0.4 to 0.6 N·m

In order to meet environmental requirements, ST offers these devices in different grades of ECOPACK® packages, depending on their level of environmental compliance. ECOPACK® specifications, grade definitions and product status are available at: www.st.com. ECOPACK® is an ST trademark.

Figure 14. TO-220AB (Nlns. & Ins. 20-up) dimension definitions

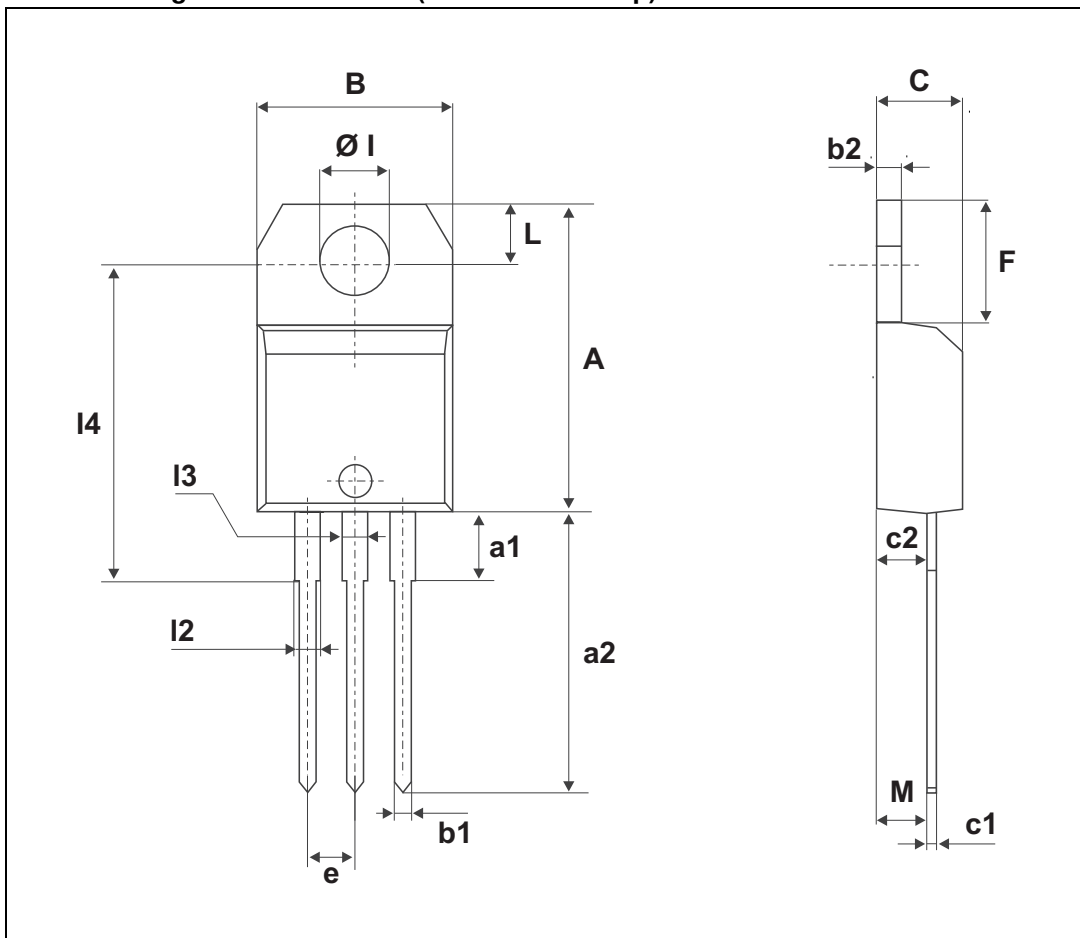

Table 5. TO-220AB (Nlns. & Ins. 20-up) dimension values

Ref.	Dimensions					
	Millimeters			Inches		
	Min.	Typ.	Max.	Min.	Typ.	Max.
A	15.20		15.90	0.598		0.625
a1		3.75			0.147	
a2	13.00		14.00	0.511		0.551
B	10.00		10.40	0.393		0.409
b1	0.61		0.88	0.024		0.034
b2	1.23		1.32	0.048		0.051
C	4.40		4.60	0.173		0.181
c1	0.49		0.70	0.019		0.027
c2	2.40		2.70	0.094		0.107
e	2.40		2.70	0.094		0.106
F	6.20		6.60	0.244		0.259
ØI	3.75		3.85	0.147		0.151
l4	15.80	16.40	16.80	0.622	0.646	0.661
L	2.65		2.95	0.104		0.116
l2	1.14		1.70	0.044		0.066
l3	1.14		1.70	0.044		0.066
M		2.60			0.102	

Figure 15. D²PAK dimensions definitions

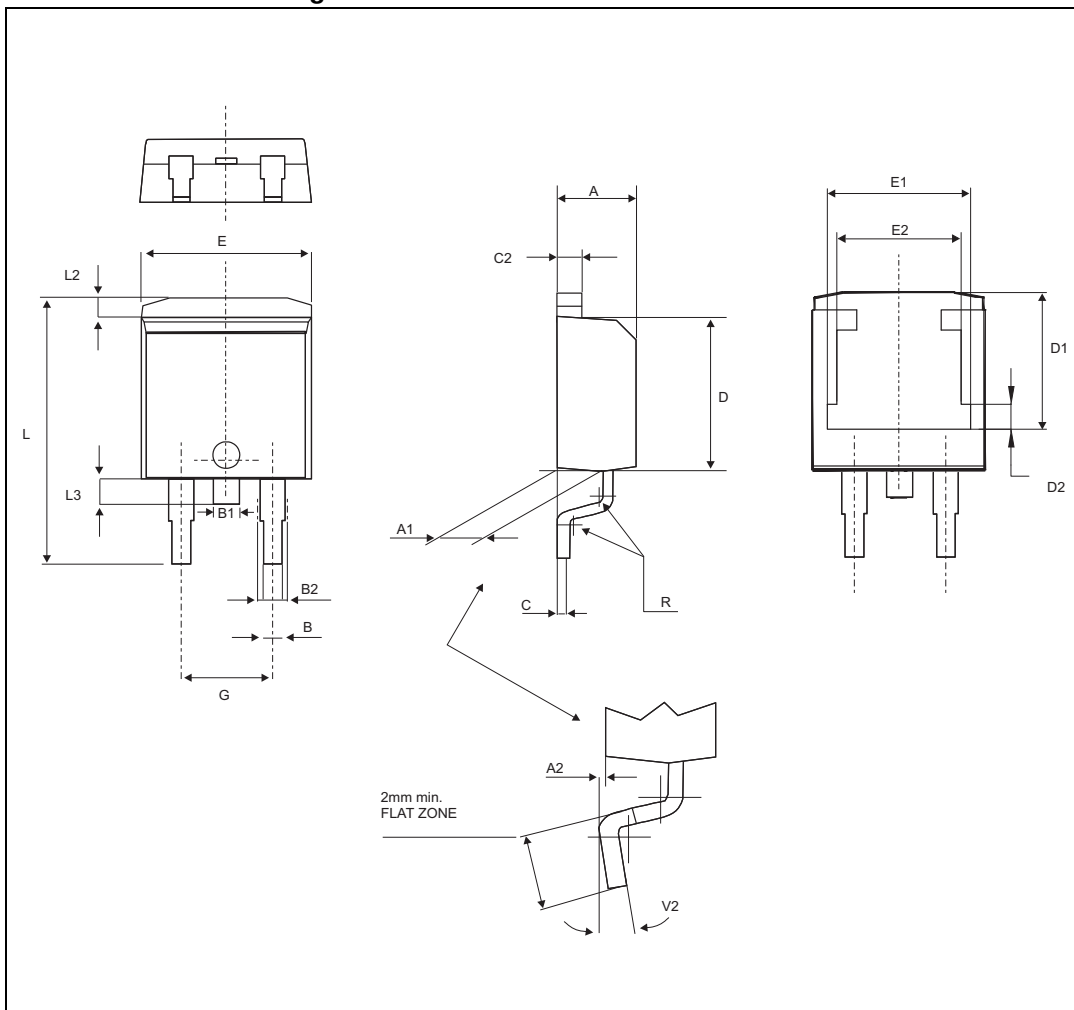
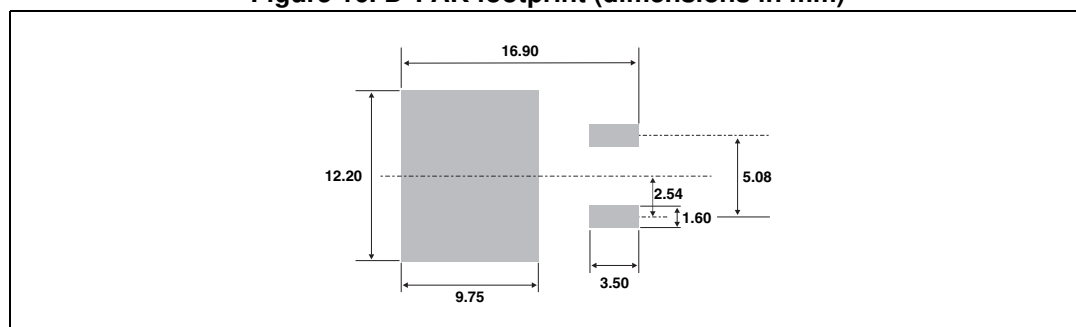

Table 6. D²PAK dimensions values

Ref.	Dimensions					
	Millimeters			Inches		
	Min.	Typ.	Max.	Min.	Typ.	Max.
A	4.30		4.60	0.169		0.181
A1	2.49		2.69	0.098		0.106
A2	0.03		0.23	0.001		0.009
B	0.70		0.93	0.027		0.037
B1	1.20		1.38	0.047		0.054
B2	1.25	1.40		0.048	0.055	
C	0.45		0.60	0.017		0.024
C2	1.21		1.36	0.047		0.054
D	8.95		9.35	0.352		0.368
D1	7.5		8.0	0.295		0.314
D2	1.3		1.7	0.051		0.067
E	10.00		10.28	0.393		0.405
E1	8.3		8.7	0.326		0.342
E2	6.85		7.25	0.269		0.285
G	4.88		5.28	0.192		0.208
L	15.00		15.85	0.590		0.624
L2	1.27		1.40	0.050		0.055
R	0.40			0.016		
V2	0°		8°	0°		8°

Figure 16. D²PAK footprint (dimensions in mm)



4 Ordering information

Table 7. Ordering information

Order code	Voltage	Sensitivity	Marking	Package	Weight	Base qty	Delivery mode
TN2540-600G-TR	600 V	40 mA	TN2540600G	D ² PAK	1.5 g	1000	Tape & reel
TN2540-800G-TR	800 V	40 mA	TN2540800G	D ² PAK	1.5 g	1000	Tape & reel
TXN625RG	600 V	40 mA	TXN625	TO-220AB ins	2.3 g	50	Tube
TYN625RG	600 V	40 mA	TYN625	TO-220AB	2.3 g	50	Tube
TYN825RG	800 V	40 mA	TYN825	TO-220AB	2.3 g	50	Tube
TYN1225RG	1200 V	40 mA	TYN1225	TO-220AB	2.3 g	50	Tube

5 Revision history

Table 8. Document revision history

Date	Revision	Changes
Apr-2002	4A	Previous update
13-Feb-2006	5	TO-220AB delivery mode changed from bulk to tube. ECOPACK statement added.
17-Jun-2011	6	Added TXN625.
13-Sep-2011	7	Added UL certification in <i>Features</i> .
07-Feb-2012	8	Added TYN1225.
20-Aug-2014	9	Updated <i>Section 3: Package information</i> .

IMPORTANT NOTICE – PLEASE READ CAREFULLY

STMicroelectronics NV and its subsidiaries ("ST") reserve the right to make changes, corrections, enhancements, modifications, and improvements to ST products and/or to this document at any time without notice. Purchasers should obtain the latest relevant information on ST products before placing orders. ST products are sold pursuant to ST's terms and conditions of sale in place at the time of order acknowledgement.

Purchasers are solely responsible for the choice, selection, and use of ST products and ST assumes no liability for application assistance or the design of Purchasers' products.

No license, express or implied, to any intellectual property right is granted by ST herein.

Resale of ST products with provisions different from the information set forth herein shall void any warranty granted by ST for such product.

ST and the ST logo are trademarks of ST. All other product or service names are the property of their respective owners.

Information in this document supersedes and replaces information previously supplied in any prior versions of this document.

© 2014 STMicroelectronics – All rights reserved

