



Chipsmall Limited consists of a professional team with an average of over 10 year of expertise in the distribution of electronic components. Based in Hongkong, we have already established firm and mutual-benefit business relationships with customers from,Europe,America and south Asia,supplying obsolete and hard-to-find components to meet their specific needs.

With the principle of “Quality Parts,Customers Priority,Honest Operation,and Considerate Service”,our business mainly focus on the distribution of electronic components. Line cards we deal with include Microchip,ALPS,ROHM,Xilinx,Pulse,ON,Everlight and Freescale. Main products comprise IC,Modules,Potentiometer,IC Socket,Relay,Connector.Our parts cover such applications as commercial,industrial, and automotives areas.

We are looking forward to setting up business relationship with you and hope to provide you with the best service and solution. Let us make a better world for our industry!



## Contact us

Tel: +86-755-8981 8866 Fax: +86-755-8427 6832

Email & Skype: info@chipsmall.com Web: www.chipsmall.com

Address: A1208, Overseas Decoration Building, #122 Zhenhua RD., Futian, Shenzhen, China

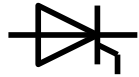

**Key Parameters**

$V_{DRM} / V_{RRM}$	1200V - 1600V
$I_{TAVM}$	600A ( $T_C=85^\circ\text{C}$ )
$I_{TSM}$	17000A
$V_{TO}$	0,9V
$r_T$	0,27m $\Omega$
$R_{thJC}$	0,062K/W
Base plate	50mm



For type designation please refer to actual short form catalog

<http://www.ifbip.com/catalog>

**Merkmale**

- Druckkontakt-Technologie für hohe Zuverlässigkeit
- Industrie-Standard-Gehäuse
- Elektrisch isolierte Bodenplatte

**Features**

- Pressure contact technology for high reliability
- Industrial standard package
- Electrically insulated base plate

**Typische Anwendungen**

- Sanftanlasser
- Gleichrichter für Antriebsapplikationen
- Kurzschließer-Applikationen
- Leistungssteller
- Gleichrichter für UPS
- Batterieladegleichrichter
- Statische Umschalter
- Bypass-Schalter

**Typical Applications**

- Soft starter
- Rectifier for drives applications
- Crowbar applications
- Power controllers
- Rectifiers for UBS
- Battery chargers
- Static switches
- Bypass switch

content of customer DMX code	DMX code digit	DMX code digit quantity
serial number	1..5	5
SAP material number	6..12	7
Internal production order number	13..20	8
datecode (production year)	21..22	2
datecode (production week)	23..24	2

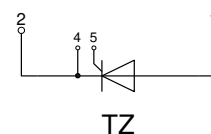

[www.ifbip.com](http://www.ifbip.com)  
[support@infineon-bip.com](mailto:support@infineon-bip.com)



## TZ600N

## Elektrische Eigenschaften / Electrical properties

Höchstzulässige Werte / Maximum rated values

Periodische Vorwärts- und Rückwärts-Spitzensperrspannung repetitive peak forward off-state and reverse voltages	$T_{vj} = -40^{\circ}\text{C} \dots T_{vj\text{max}}$	$V_{\text{DRM}}, V_{\text{RRM}}$	1200 1400 1600	V V
Vorwärts-Stoßspitzensperrspannung non-repetitive peak forward off-state voltage	$T_{vj} = -40^{\circ}\text{C} \dots T_{vj\text{max}}$	$V_{\text{DSM}}$	1200 1400 1600	V V
Rückwärts-Stoßspitzensperrspannung non-repetitive peak reverse voltage	$T_{vj} = +25^{\circ}\text{C} \dots T_{vj\text{max}}$	$V_{\text{RSM}}$	1300 1500 1700	V
Durchlaßstrom-Grenzeffektivwert maximum RMS on-state current		$I_{\text{TRMSM}}$	1050	A
Dauergrenzstrom average on-state current	$T_{\text{C}} = 85^{\circ}\text{C}$ $T_{\text{C}} = 77^{\circ}\text{C}$	$I_{\text{TAVM}}$	600 669	A A
Stoßstrom-Grenzwert surge current	$T_{vj} = 25^{\circ}\text{C}, t_{\text{p}} = 10\text{ ms}$ $T_{vj} = T_{vj\text{max}}, t_{\text{p}} = 10\text{ ms}$	$I_{\text{TSM}}$	17.000 14.000	A A
Grenzlastintegral $I^2t$ -value	$T_{vj} = 25^{\circ}\text{C}, t_{\text{p}} = 10\text{ ms}$ $T_{vj} = T_{vj\text{max}}, t_{\text{p}} = 10\text{ ms}$	$I^2t$	1.445.000 980.000	$\text{A}^2\text{s}$ $\text{A}^2\text{s}$
Kritische Stromsteilheit critical rate of rise of on-state current	DIN IEC 747-6 $f = 50\text{ Hz}, i_{\text{GM}} = 1\text{ A}, di_{\text{G}}/dt = 1\text{ A}/\mu\text{s}$	$(di_{\text{T}}/dt)_{\text{cr}}$	200	$\text{A}/\mu\text{s}$
Kritische Spannungssteilheit critical rate of rise of off-state voltage	$T_{vj} = T_{vj\text{max}}, v_{\text{D}} = 0,67 V_{\text{DRM}}$ 6.Kennbuchstabe / 6 <sup>th</sup> letter F	$(dv_{\text{D}}/dt)_{\text{cr}}$	1000	$\text{V}/\mu\text{s}$

## Charakteristische Werte / Characteristic values

Durchlaßspannung on-state voltage	$T_{vj} = T_{vj\text{max}}, i_{\text{T}} = 1700\text{ A}$	$v_{\text{T}}$	max. 1,53	V
Schleusenspannung threshold voltage	$T_{vj} = T_{vj\text{max}}$	$V_{(\text{TO})}$	0,9	V
Ersatzwiderstand slope resistance	$T_{vj} = T_{vj\text{max}}$	$r_{\text{T}}$	0,27	$\text{m}\Omega$
Zündstrom gate trigger current	$T_{vj} = 25^{\circ}\text{C}, v_{\text{D}} = 6\text{ V}$	$I_{\text{GT}}$	max. 250	$\text{mA}$
Zündspannung gate trigger voltage	$T_{vj} = 25^{\circ}\text{C}, v_{\text{D}} = 6\text{ V}$	$V_{\text{GT}}$	max. 2,2	V
Nicht zündender Steuerstrom gate non-trigger current	$T_{vj} = T_{vj\text{max}}, v_{\text{D}} = 6\text{ V}$ $T_{vj} = T_{vj\text{max}}, v_{\text{D}} = 0,5 V_{\text{DRM}}$	$I_{\text{GD}}$	max. 10 max. 5	$\text{mA}$ $\text{mA}$
Nicht zündende Steuerspannung gate non-trigger voltage	$T_{vj} = T_{vj\text{max}}, v_{\text{D}} = 0,5 V_{\text{DRM}}$	$V_{\text{GD}}$	max. 0,25	V
Haltestrom holding current	$T_{vj} = 25^{\circ}\text{C}, v_{\text{D}} = 6\text{ V}, R_{\text{A}} = 5\ \Omega$	$I_{\text{H}}$	max. 300	$\text{mA}$
Einraststrom latching current	$T_{vj} = 25^{\circ}\text{C}, v_{\text{D}} = 6\text{ V}, R_{\text{GK}} \geq 10\ \Omega$ $i_{\text{GM}} = 1\text{ A}, di_{\text{G}}/dt = 1\text{ A}/\mu\text{s}, t_{\text{g}} = 20\ \mu\text{s}$	$I_{\text{L}}$	max. 1500	$\text{mA}$
Vorwärts- und Rückwärts-Sperrstrom forward off-state and reverse current	$T_{vj} = T_{vj\text{max}}$ $v_{\text{D}} = V_{\text{DRM}}, v_{\text{R}} = V_{\text{RRM}}$	$i_{\text{D}}, i_{\text{R}}$	max. 140	$\text{mA}$
Zündverzug gate controlled delay time	DIN IEC 747-6 $T_{vj} = 25^{\circ}\text{C}, i_{\text{GM}} = 1\text{ A}, di_{\text{G}}/dt = 1\text{ A}/\mu\text{s}$	$t_{\text{gd}}$	max. 4	$\mu\text{s}$

prepared by: A. Glunz	date of publication: 2018.07.16
approved by: M. Stelle	revision: 3.4

**Elektrische Eigenschaften / Electrical properties**

Charakteristische Werte / Characteristic values

Freiwerdezeit circuit commutated turn-off time	$T_{vj} = T_{vj\ max}$ , $i_{TM} = I_{TAVM}$ $V_{RM} = 100\ V$ , $V_{DM} = 0,67\ V_{DRM}$ $dv_D/dt = 20\ V/\mu s$ , $-di_T/dt = 10\ A/\mu s$ 5.Kennbuchstabe / 5 <sup>th</sup> letter O	$t_q$	typ.	250	$\mu s$
Isolations-Prüfspannung insulation test voltage	RMS, $f = 50\ Hz$ , $t = 1\ min$ RMS, $f = 50\ Hz$ , $t = 1\ sec$	$V_{ISOL}$		3,0 3,6	kV kV

**Thermische Eigenschaften / Thermal properties**

Innere Wärmewiderstand thermal resistance, junction to case	pro Modul / per Module, $\Theta = 180^\circ\ sin$ pro Modul / per Module, DC	$R_{thJC}$	max.	0,065	$^\circ C/W$
			max.	0,062	$^\circ C/W$
Übergangs-Wärmewiderstand thermal resistance, case to heatsink	pro Modul / per Module	$R_{thCH}$	max.	0,02	$^\circ C/W$
Höchstzulässige Sperrschichttemperatur maximum junction temperature		$T_{vj\ max}$		135	$^\circ C$
Betriebstemperatur operating temperature		$T_{c\ op}$		-40...+135	$^\circ C$
Lagertemperatur storage temperature		$T_{stg}$		-40...+140	$^\circ C$

**Mechanische Eigenschaften / Mechanical properties**

Gehäuse, siehe Anlage case, see annex				Seite 4 page 4	
Si-Element mit Druckkontakt Si-pellet with pressure contact					
Innere Isolation internal insulation				AIN	
Anzugsdrehmoment für mechanische Anschlüsse mounting torque	Toleranz / Tolerance $\pm 15\%$	M1		5	Nm
Anzugsdrehmoment für elektrische Anschlüsse terminal connection torque	Toleranz / Tolerance $\pm 10\%$	M2		12	Nm
Steueranschlüsse control terminals	DIN 46 244			A 2,8 x 0,8	
Gewicht weight		G	typ.	900	g
Kriechstrecke creepage distance				15	mm
Schwingfestigkeit vibration resistance	$f = 50\ Hz$			50	$m/s^2$
	file-No.			E 83335	

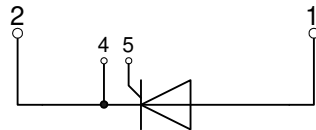
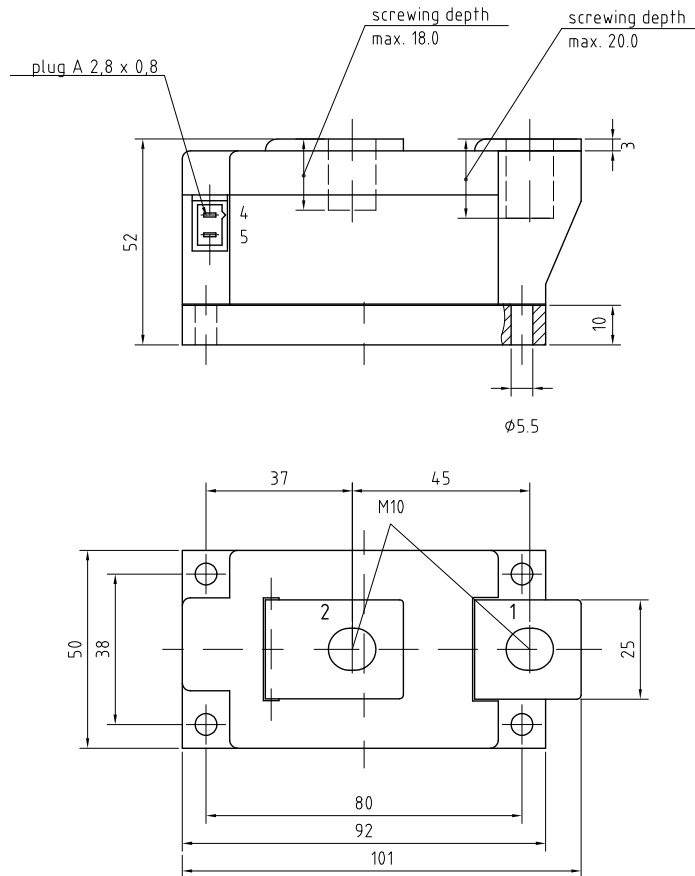
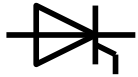

**TZ**

**Analytische Elemente des transienten Wärmewiderstandes  $Z_{thJC}$  für DC**  
**Analytical elements of transient thermal impedance  $Z_{thJC}$  for DC**

Pos. n	1	2	3	4	5	6	7
$R_{thn}$ [°C/W]	0,00137	0,00486	0,0114	0,0223	0,0221		
$\tau_n$ [s]	0,00076	0,0086	0,101	0,56	3,12		

Analytische Funktion / Analytical function: 
$$Z_{thJC} = \sum_{n=1}^{n_{max}} R_{thn} \left( 1 - e^{-\frac{t}{\tau_n}} \right)$$

Luftselbstkühlung / Natural cooling  
3 Module pro Kühlkörper / 3 modules per heatsink  
Kühlkörper / Heatsink type: KM17 (90W)

**Analytische Elemente des transienten Wärmewiderstandes  $Z_{thCA}$**   
**Analytical elements of transient thermal impedance  $Z_{thCA}$** 

Pos. n	1	2	3	4	5	6	7
$R_{thn}$ [°C/W]	0,796	0,005	0,041				
$\tau_n$ [s]	1420	912	12				

Verstärkte Kühlung / Forced cooling  
3 Module pro Kühlkörper / 3 modules per heatsink  
Kühlkörper / Heatsink type: KM17 (Papst 4650N)

**Analytische Elemente des transienten Wärmewiderstandes  $Z_{thCA}$**   
**Analytical elements of transient thermal impedance  $Z_{thCA}$** 

Pos. n	1	2	3	4	5	6	7
$R_{thn}$ [°C/W]	0,239	0,0435	0,0075				
$\tau_n$ [s]	497	31,8	6,4				

Analytische Funktion / Analytical function: 
$$Z_{thCA} = \sum_{n=1}^{n_{max}} R_{thn} \left( 1 - e^{-\frac{t}{\tau_n}} \right)$$

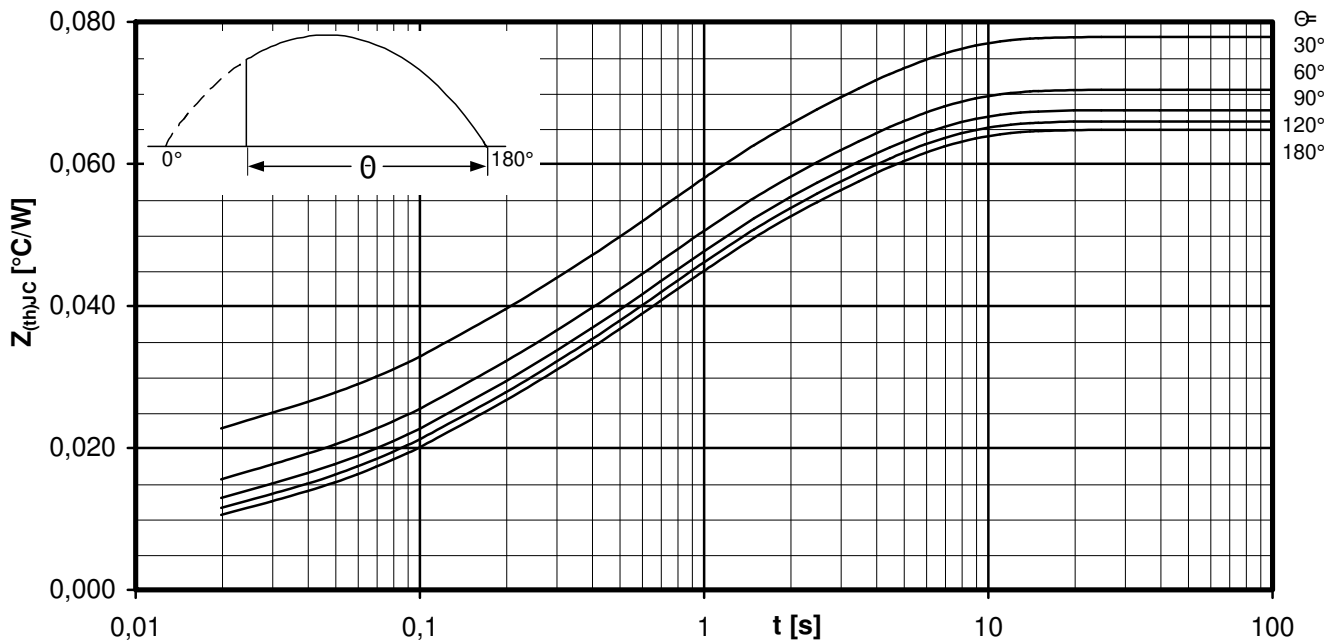

Transienter innerer Wärmewiderstand je Zweig / Transient thermal impedance per arm  $Z_{thJC} = f(t)$

Sinusförmiger Strom / Sinusoidal current

Parameter: Stromflußwinkel  $\Theta$  / Current conduction angle  $\Theta$

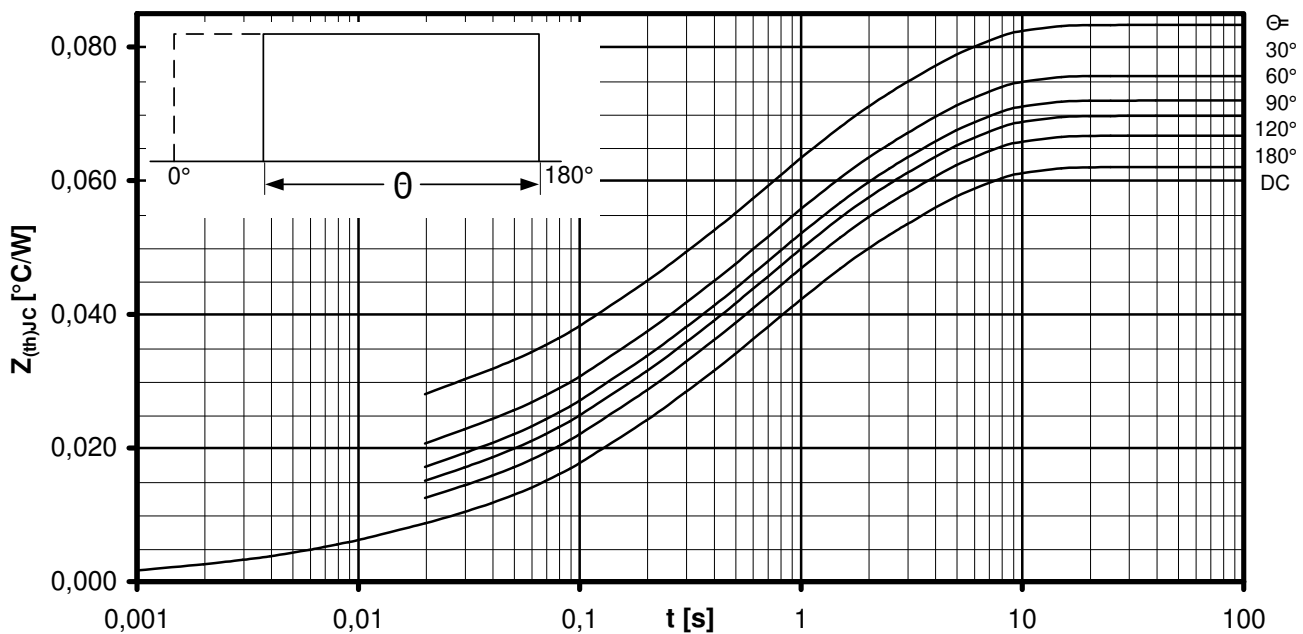

Transienter innerer Wärmewiderstand je Zweig / Transient thermal impedance per arm  $Z_{thJC} = f(t)$

Rechteckförmiger Strom / Rectangular current

Parameter: Stromflußwinkel  $\Theta$  / Current conduction angle  $\Theta$

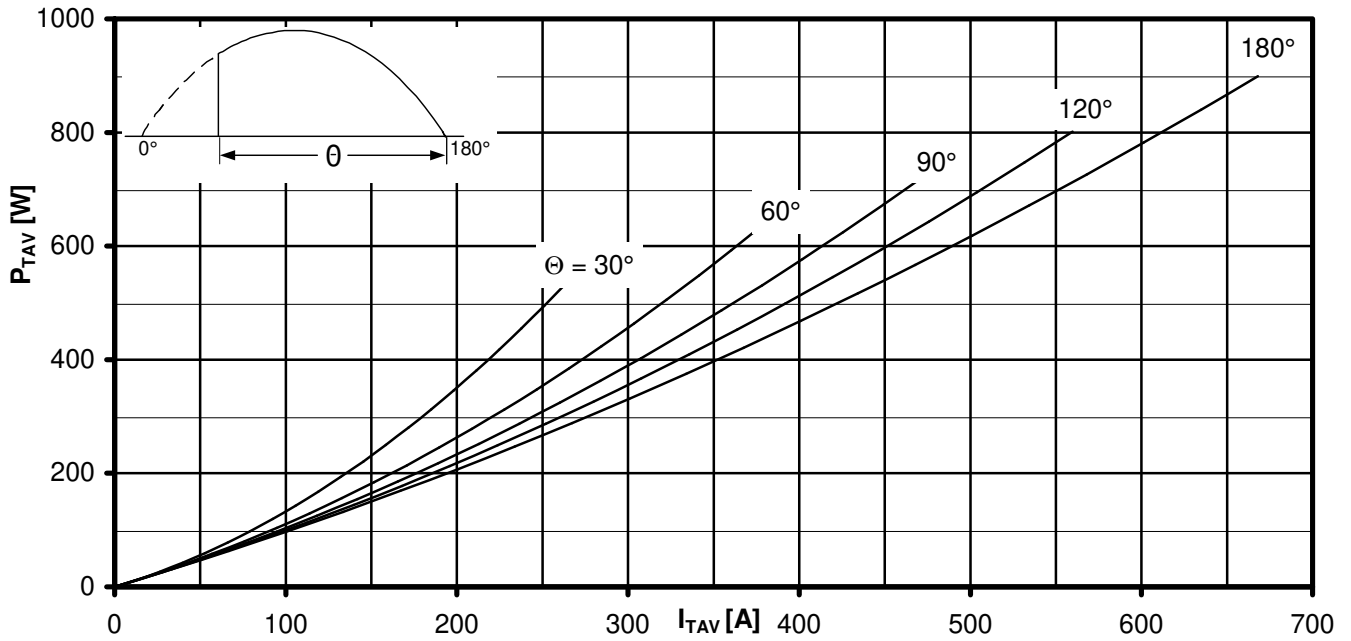
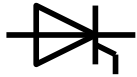

**Durchlassverlustleistung je Zweig / On-state power loss per arm  $P_{TAV} = f(I_{TAV})$**

Sinusförmiger Strom / Sinusoidal current    Strombelastung je Zweig / Current load per arm

Parameter: Stromflußwinkel / Current conduction angle  $\Theta$

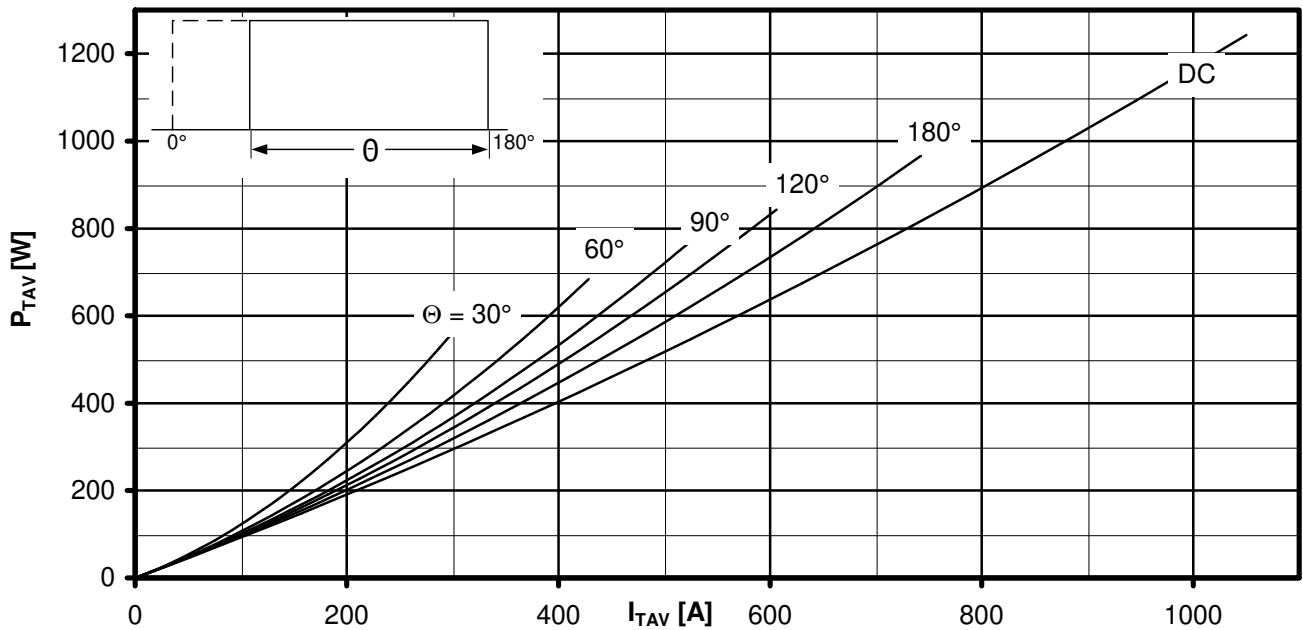

**Durchlassverlustleistung je Zweig / On-state power loss per arm  $P_{TAV} = f(I_{TAV})$**

Rechteckförmiger Strom / Rectangular current    Strombelastung je Zweig / Current load per arm

Parameter: Stromflußwinkel / Current conduction angle  $\Theta$



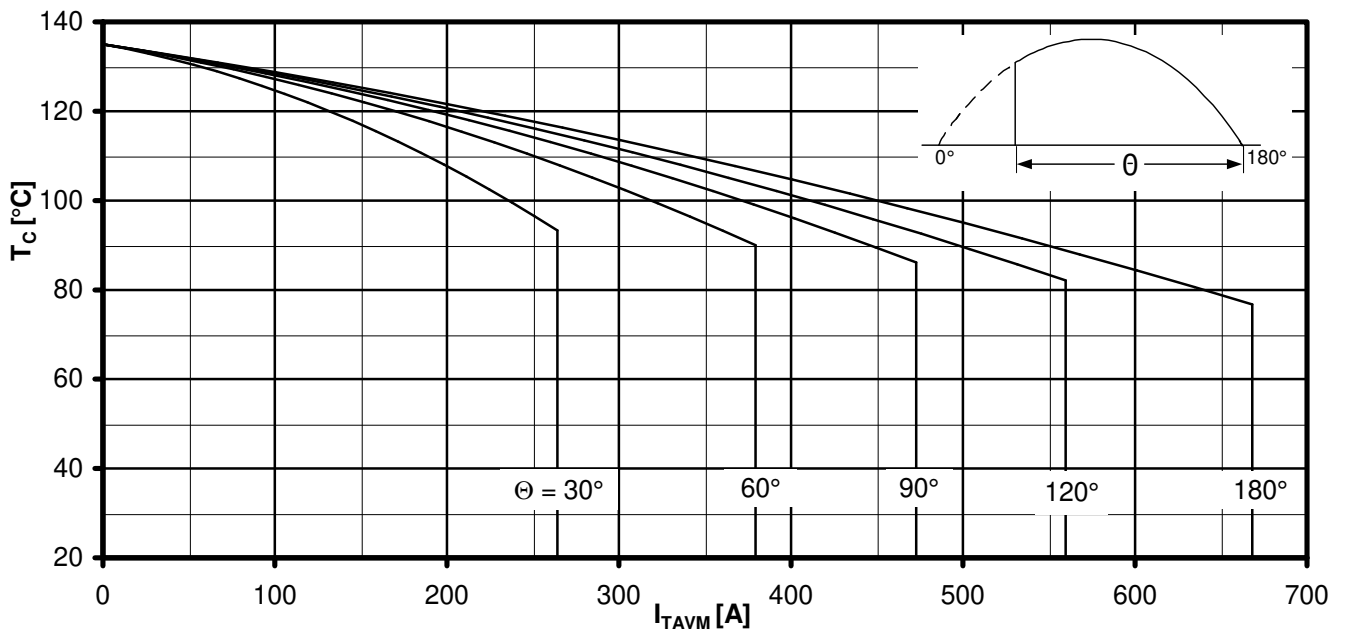
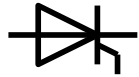

Höchstzulässige Gehäusetemperatur / Maximum allowable case temperature  $T_c = f(I_{TAVM})$

Sinusförmiger Strom / Sinusoidal current Strombelastung je Zweig / Current load per arm

Parameter: Stromflußwinkel  $\Theta$  / Current conduction angle  $\Theta$

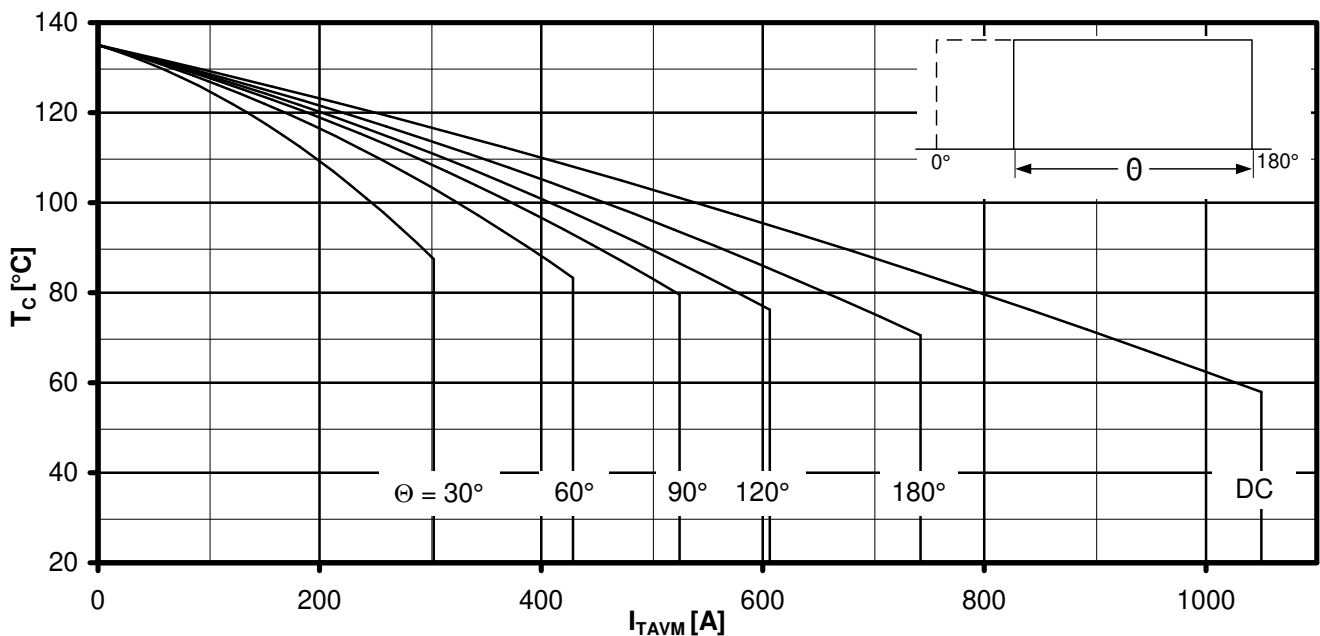

Höchstzulässige Gehäusetemperatur / Maximum allowable case temperature  $T_c = f(I_{TAVM})$

Rechteckförmiger Strom / Rectangular current Strombelastung je Zweig / Current load per arm

Parameter: Stromflußwinkel  $\Theta$  / Current conduction angle  $\Theta$

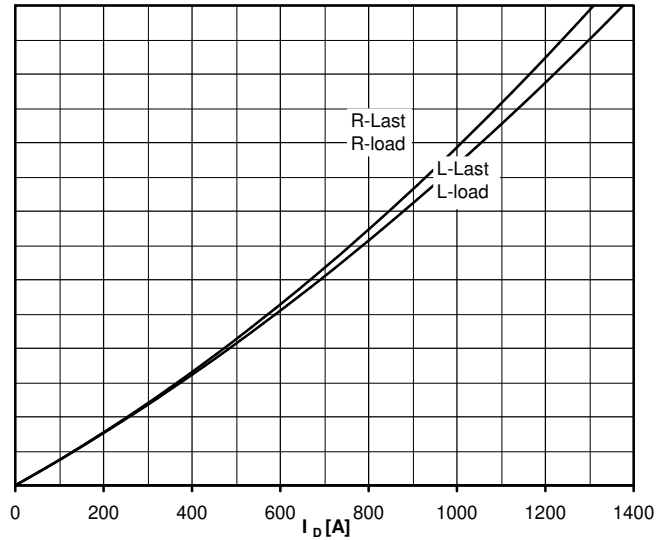
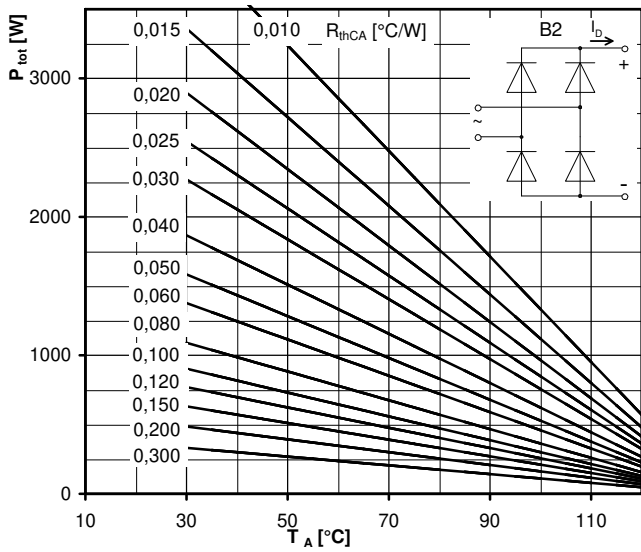
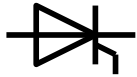

**Höchstzulässiger Ausgangsstrom / Maximum rated output current  $I_D$**

B2- Zweipuls-Brückenschaltung / Two-pulse bridge circuit

Gesamtverlustleistung der Schaltung / Total power dissipation at circuit  $P_{tot}$

Parameter:

Wärmewiderstand zwischen den Gehäusen und Umgebung / Thermal resistance cases to ambient  $R_{thCA}$

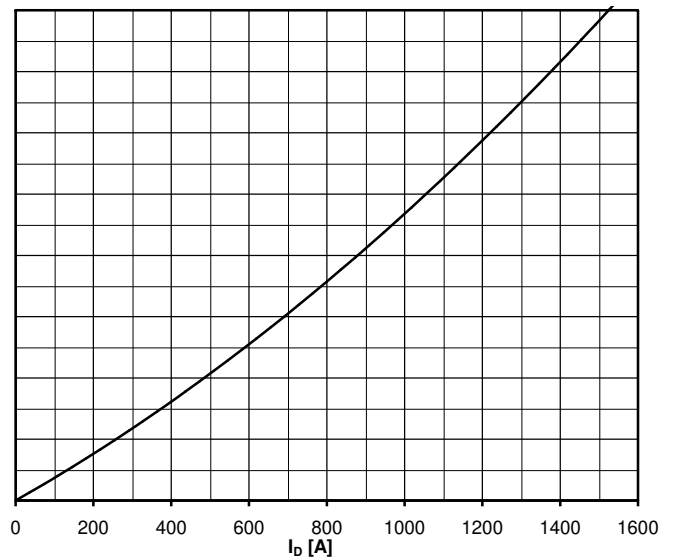
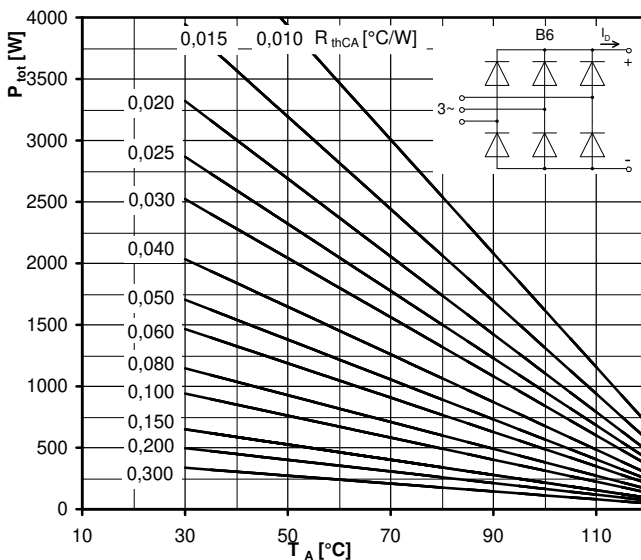

**Höchstzulässiger Ausgangsstrom / Maximum rated output current  $I_D$**

B6- Sechspuls-Brückenschaltung / Six-pulse bridge circuit

Gesamtverlustleistung der Schaltung / Total power dissipation at circuit  $P_{tot}$

Parameter:

Wärmewiderstand zwischen den Gehäusen und Umgebung / Thermal resistance cases to ambient  $R_{thCA}$

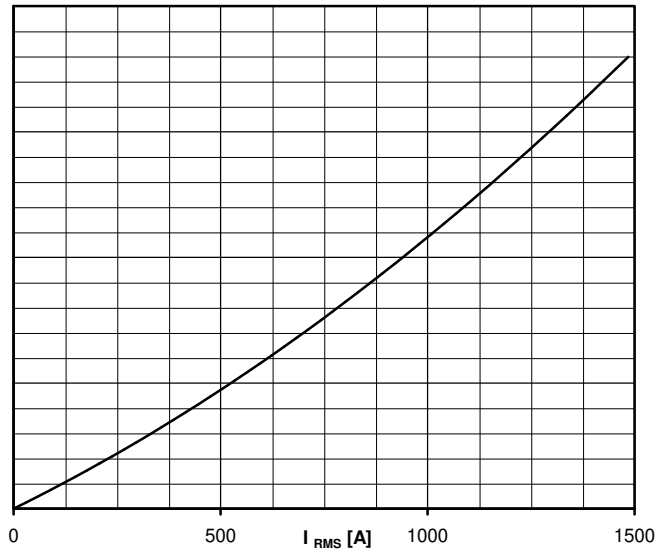
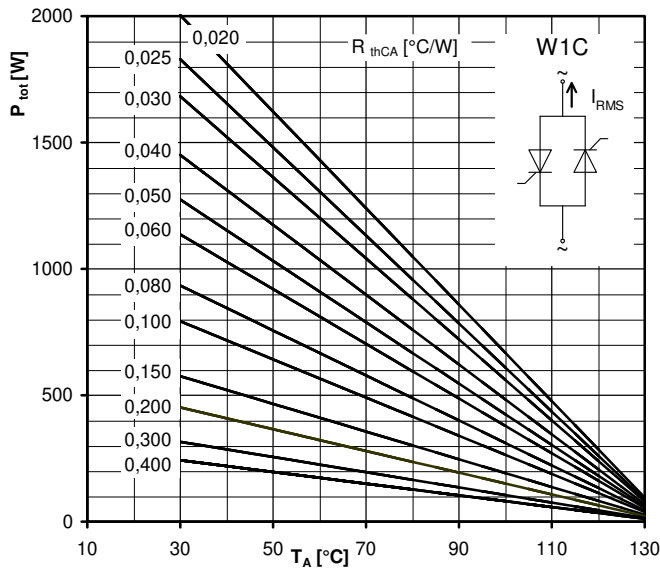

### Höchstzulässiger Effektivstrom / Maximum rated RMS current $I_{RMS}$

W1C - Einphasen-Wechselwegschaltung / Single-phase inverse parallel circuit

Gesamtverlustleistung der Schaltung / Total power dissipation at circuit  $P_{tot}$

Parameter:

Wärmewiderstand zwischen den Gehäusen und Umgebung / Thermal resistance case to ambient  $R_{thCA}$

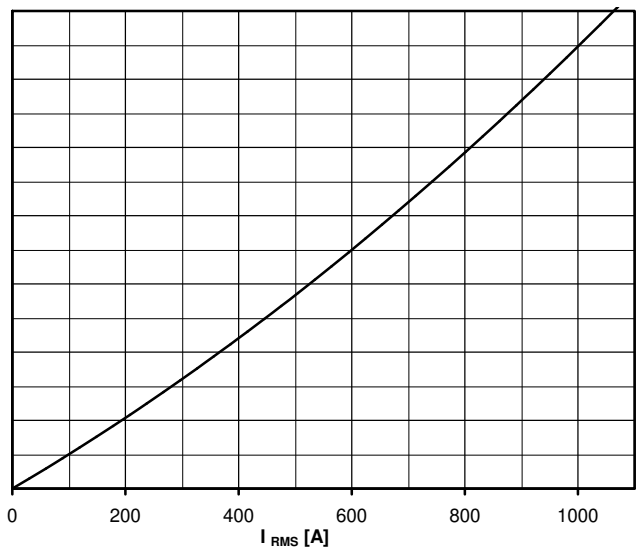
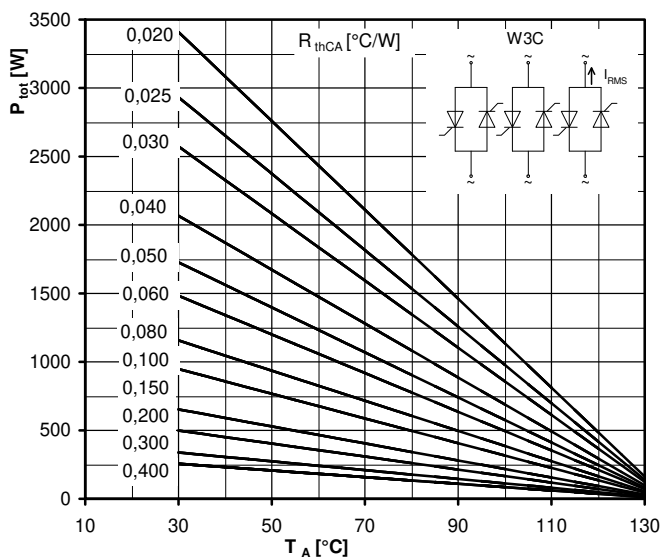

### Höchstzulässiger Effektivstrom / Maximum rated RMS current $I_{RMS}$

W3C - Dreiphasen-Wechselwegschaltung / Three-phase inverse parallel circuit

Gesamtverlustleistung der Schaltung / Total power dissipation at circuit  $P_{tot}$

Parameter:

Wärmewiderstand zwischen den Gehäusen und Umgebung / Thermal resistance cases to ambient  $R_{thCA}$

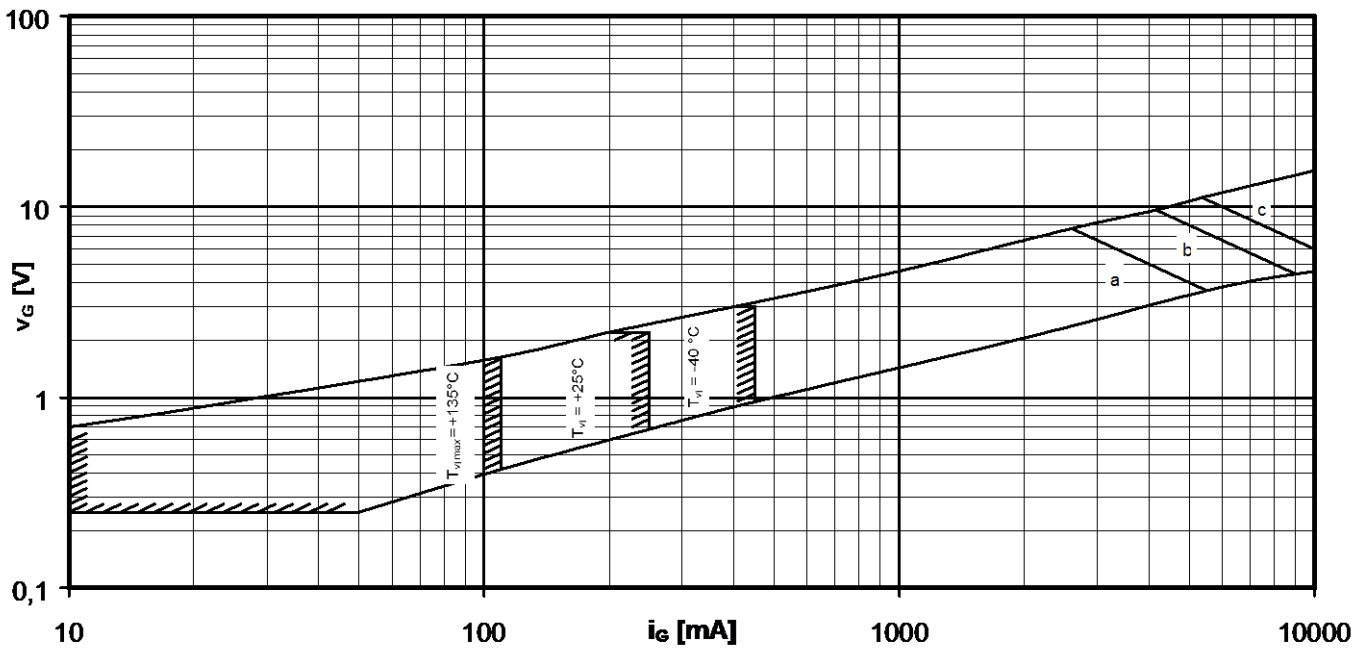
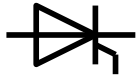

Steuercharakteristik  $v_G = f(i_G)$  mit Zündbereichen für  $V_D = 6\text{ V}$   
Gate characteristic  $v_G = f(i_G)$  with triggering area for  $V_D = 6\text{ V}$

Höchstzulässige Spitzensteuerverlustleistung / Maximum rated peak gate power dissipation  $P_{GM} = f(t_G)$  :

a - 20 W/10ms    b - 40 W/1ms    c - 60 W/0,5ms

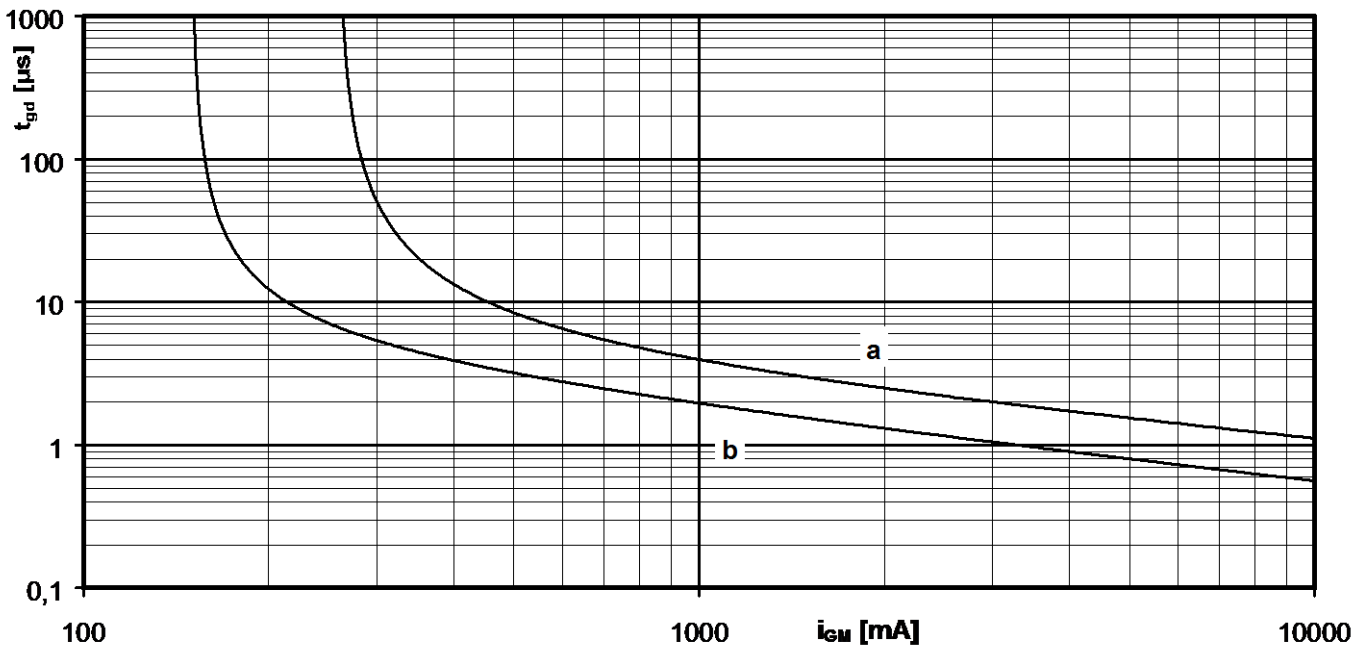

Zündverzögerung / Gate controlled delay time  $t_{gd} = f(i_G)$

$T_{vj} = 25^\circ\text{C}$ ,  $di_G/dt = i_{GM}/1\mu\text{s}$

a - maximaler Verlauf / Limiting characteristic

b - typischer Verlauf / Typical characteristic

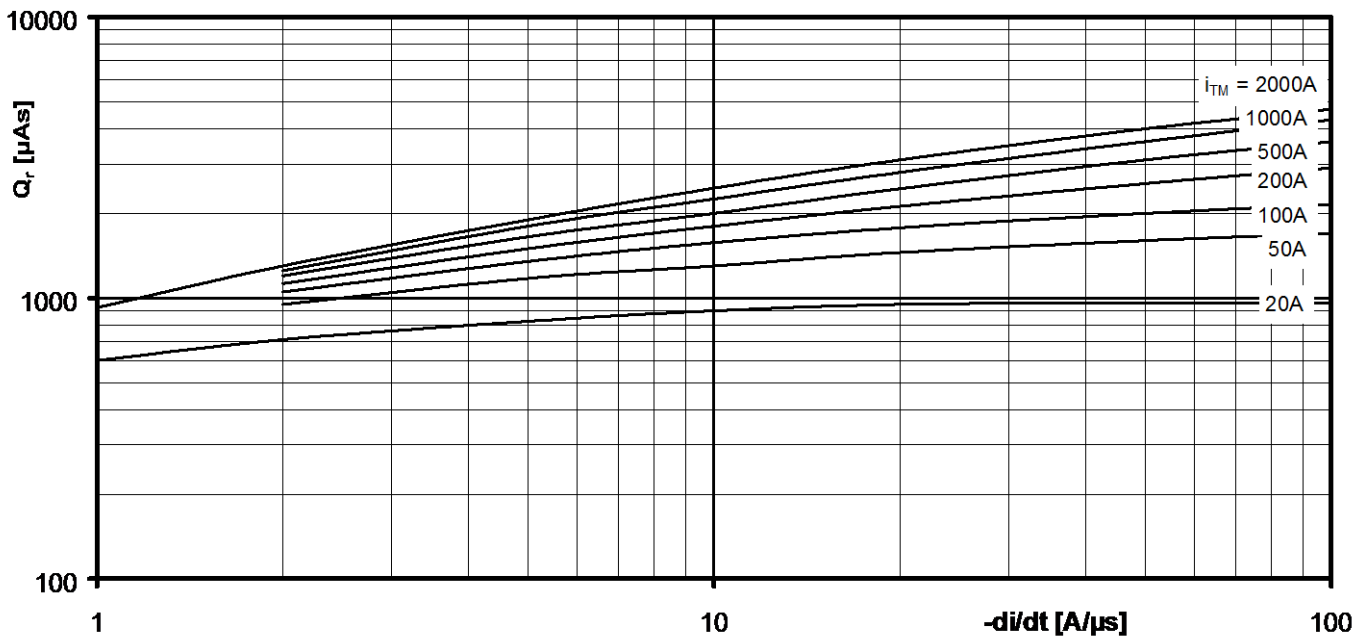
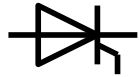

Sperrverzögerungsladung / Recovered charge  $Q_r = f(-di/dt)$

$$T_{vj} = T_{vjmax}, v_R \leq 0,5 V_{RRM}, v_{RM} = 0,8 V_{RRM}$$

Parameter: Durchlaßstrom / On-state current  $i_{TM}$

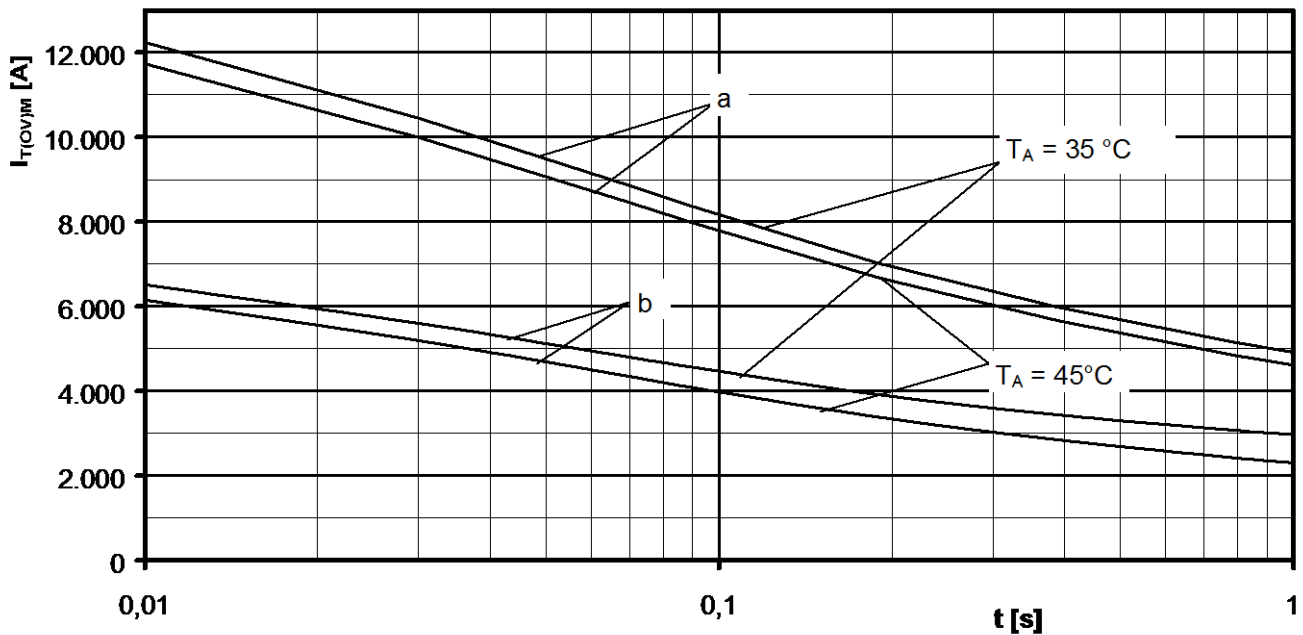

Grenzstrom / Maximum overload on-state current  $I_{T(OV)M} = f(t), v_{RM} = 0,8 V_{RRM}$

a: Leerlauf / No-load conditions

b: nach Belastung mit  $I_{TAVM}$  / after load with  $I_{TAVM}$

$T_A = 35^\circ\text{C}$ , verstärkte Luftkühlung / Forced air cooling

$T_A = 45^\circ\text{C}$ , Luftselbstkühlung / Natural air cooling

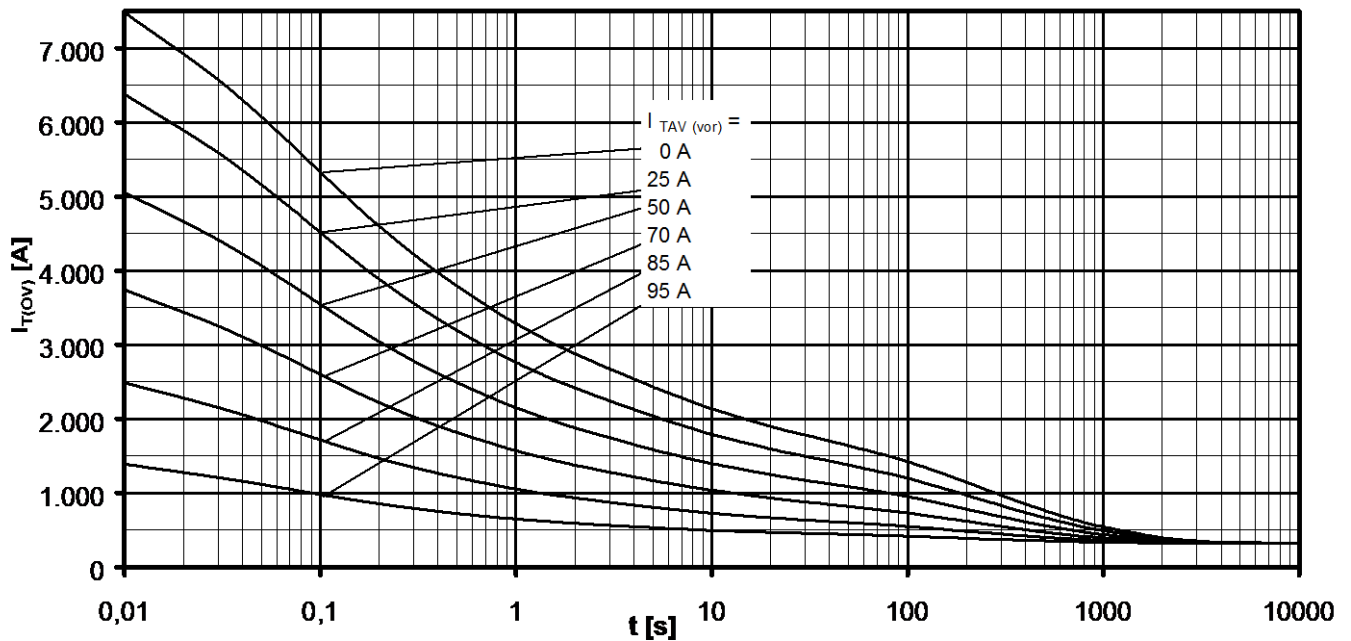

Überstrom je Zweig / Overload on-state current  $I_{T(ov)}$

B6- Sechspuls-Brückenschaltung, 120° Rechteck / Six-pulse bridge circuit, 120° rectangular

Kühlkörper / Heatsink type KM17 (90W)    Luftselbstkühlung bei / Natural cooling at  $T_A = 45^\circ\text{C}$

Parameter: Vorlaststrom je Zweig / Pre-load current per arm  $I_{TAV(vor)}$

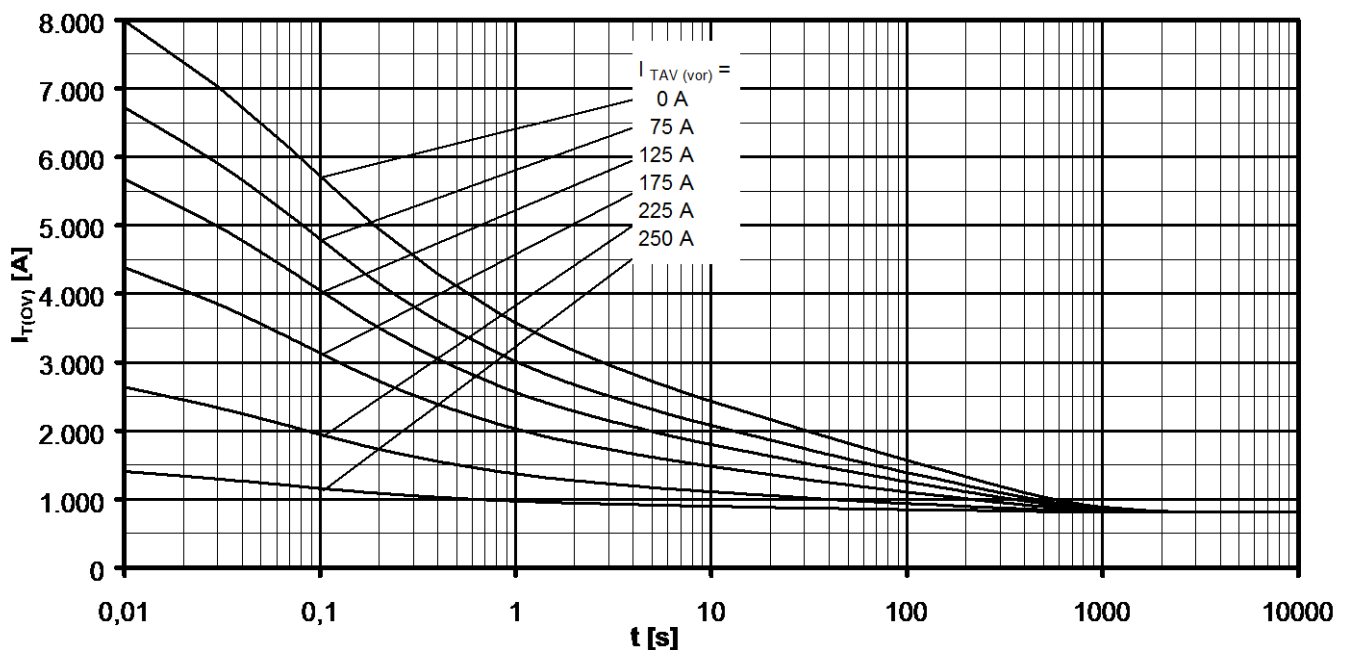

Überstrom je Zweig / Overload on-state current  $I_{T(ov)}$

B6- Sechspuls-Brückenschaltung, 120° Rechteck / Six-pulse bridge circuit, 120° rectangular

Kühlkörper / Heatsink type KM17 (Papst 4650N)    Verstärkte Kühlung bei / Forced cooling at  $T_A = 35^\circ\text{C}$

Parameter: Vorlaststrom je Zweig / Pre-load current per arm  $I_{TAV(vor)}$