



Chipsmall Limited consists of a professional team with an average of over 10 year of expertise in the distribution of electronic components. Based in Hongkong, we have already established firm and mutual-benefit business relationships with customers from,Europe,America and south Asia,supplying obsolete and hard-to-find components to meet their specific needs.

With the principle of “Quality Parts,Customers Priority,Honest Operation,and Considerate Service”,our business mainly focus on the distribution of electronic components. Line cards we deal with include Microchip,ALPS,ROHM,Xilinx,Pulse,ON,Everlight and Freescale. Main products comprise IC,Modules,Potentiometer,IC Socket,Relay,Connector.Our parts cover such applications as commercial,industrial, and automotives areas.

We are looking forward to setting up business relationship with you and hope to provide you with the best service and solution. Let us make a better world for our industry!



Contact us

Tel: +86-755-8981 8866 Fax: +86-755-8427 6832

Email & Skype: info@chipsmall.com Web: www.chipsmall.com

Address: A1208, Overseas Decoration Building, #122 Zhenhua RD., Futian, Shenzhen, China





Technische Information / technical information



Netz-Thyristor-Modul
Phase Control Thyristor Module

TZ740N

Infineon Technologies Bipolar
GmbH & Co. KG

Key Parameters

V_{DRM} / V_{RRM}	2000V / 2200V
I_{TAVM}	819A ($T_C=85^\circ\text{C}$)
I_{TSM}	30000A
V_{T0}	0,82V
r_T	0,17m Ω
R_{thJC}	0,0405K/W
Base plate	70mm
Weight	1950g



For type designation please refer to actual short form catalog

<http://www.ifbip.com/catalog>

Merkmale

- Druckkontakt-Technologie für hohe Zuverlässigkeit
- Advanced Medium Power Technology (AMPT)
- Industrie-Standard-Gehäuse
- Elektrisch isolierte Bodenplatte
- Optional: Thermisches Interface Material (TIM) bereits aufgetragen

Features

- Pressure contact technology for high reliability
- Advanced Medium Power Technology (AMPT)
- Industrial standard package
- Electrically insulated base plate
- Option: Pre-applied thermal interface material (TIM)

Typische Anwendungen

- Sanftanlasser
- Gleichrichter für Antriebsapplikationen
- Kurzschließer-Applikationen
- Leistungssteller
- Gleichrichter für UPS
- Batterieladegleichrichter
- Statische Umschalter

Typical Applications

- Soft starter
- Rectifier for drives applications
- Crowbar applications
- Power controllers
- Rectifiers for UBS
- Battery chargers
- Static switches

content of customer DMX code	DMX code digit	DMX code digit quantity
serial number	1..7	7
SP material number	8..16	9
datecode (production day)	17..18	2
datecode (production year)	19..20	2
datecode (production month)	21..22	2
vT class	23..26	4
QR class	27..30	4

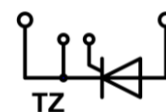

www.ifbip.com
support@infineon-bip.com



Technische Information / technical information



Netz-Thyristor-Modul
Phase Control Thyristor Module

TZ740N

Infineon Technologies Bipolar
GmbH & Co. KG

TZ740N
TZ740N22KOF_TIM

Elektrische Eigenschaften / Electrical properties
Höchstzulässige Werte / Maximum rated values

Periodische Vorwärts- und Rückwärts-Spitzensperrspannung repetitive peak forward off-state and reverse voltages	$T_{vj} = -40^{\circ}\text{C} \dots T_{vj\text{ max}}$	$V_{\text{DRM}}, V_{\text{RRM}}$	2000	2200	V
Vorwärts-Stoßspitzensperrspannung non-repetitive peak forward off-state voltage	$T_{vj} = -40^{\circ}\text{C} \dots T_{vj\text{ max}}$	V_{DSM}	2000	2200	V
Rückwärts-Stoßspitzensperrspannung non-repetitive peak reverse voltage	$T_{vj} = +25^{\circ}\text{C} \dots T_{vj\text{ max}}$	V_{RSM}	2100	2300	V
Durchlaßstrom-Grenzeffektivwert maximum RMS on-state current		I_{TRMSM}		1500	A
Dauergrenzstrom average on-state current	$T_{\text{C}} = 85^{\circ}\text{C}$	I_{TAVM}		819	A
Stoßstrom-Grenzwert surge current	$T_{vj} = 25^{\circ}\text{C}, t_{\text{p}} = 10\text{ms}$ $T_{vj} = T_{vj\text{ max}}, t_{\text{p}} = 10\text{ms}$	I_{TSM}		30000 26500	A A
Grenzlastintegral I^2t -value	$T_{vj} = 25^{\circ}\text{C}, t_{\text{p}} = 10\text{ms}$ $T_{vj} = T_{vj\text{ max}}, t_{\text{p}} = 10\text{ms}$	I^2t		4500000 3500000	A^2s A^2s
Kritische Stromsteilheit critical rate of rise of on-state current	DIN IEC 747-6 $f = 50\text{Hz}, i_{\text{GM}} = 1\text{A}, di_{\text{G}}/dt = 1\text{A}/\mu\text{s}$	$(di_{\text{T}}/dt)_{\text{cr}}$		200	$\text{A}/\mu\text{s}$
Kritische Spannungssteilheit critical rate of rise of off-state voltage	$T_{vj} = T_{vj\text{ max}}, v_{\text{D}} = 0,67 V_{\text{DRM}}$ 6. Kennbuchstabe / 6 th letter F	$(dv_{\text{D}}/dt)_{\text{cr}}$		1000	$\text{V}/\mu\text{s}$

Charakteristische Werte / Characteristic values

Durchlaßspannung on-state voltage	$T_{vj} = T_{vj\text{ max}}, I_{\text{T}} = 3000\text{ A}$	v_{T}	max.	1,51	V
Schleusenspannung threshold voltage	$T_{vj} = T_{vj\text{ max}}$	$V_{(\text{TO})}$	max.	0,82	V
Ersatzwiderstand slope resistance	$T_{vj} = T_{vj\text{ max}}$	r_{T}	max.	0,17	m Ω
Zündstrom gate trigger current	$T_{vj} = 25^{\circ}\text{C}, v_{\text{D}} = 12\text{V}$	I_{GT}	max.	250	mA
Zündspannung gate trigger voltage	$T_{vj} = 25^{\circ}\text{C}, v_{\text{D}} = 12\text{V}$	V_{GT}	max.	2	V
Nicht zündender Steuerstrom gate non-trigger current	$T_{vj} = T_{vj\text{ max}}, v_{\text{D}} = 12\text{V}$ $T_{vj} = T_{vj\text{ max}}, v_{\text{D}} = 0,5 V_{\text{DRM}}$	I_{GD}	max. max.	10 5	mA mA
Nicht zündende Steuerspannung gate non-trigger voltage	$T_{vj} = T_{vj\text{ max}}, v_{\text{D}} = 0,5 V_{\text{DRM}}$	V_{GD}	max.	0,2	V
Haltestrom holding current	$T_{vj} = 25^{\circ}\text{C}, v_{\text{D}} = 12\text{V}, R_{\text{A}} = 1\Omega$	I_{H}	max.	500	mA
Einraststrom latching current	$T_{vj} = 25^{\circ}\text{C}, v_{\text{D}} = 12\text{V}, R_{\text{GK}} \geq 10\Omega$ $i_{\text{GM}} = 1\text{A}, di_{\text{G}}/dt = 1\text{A}/\mu\text{s}, t_{\text{g}} = 20\mu\text{s}$	I_{L}	max.	2500	mA
Vorwärts- und Rückwärts-Sperrstrom forward off-state and reverse current	$T_{vj} = T_{vj\text{ max}}$ $v_{\text{D}} = V_{\text{DRM}}, v_{\text{R}} = V_{\text{RRM}}$	$i_{\text{D}}, i_{\text{R}}$	max.	170	mA
Zündverzug gate controlled delay time	DIN IEC 747-6 $T_{vj} = 25^{\circ}\text{C}, i_{\text{GM}} = 1\text{A}, di_{\text{G}}/dt = 1\text{A}/\mu\text{s}$	t_{gd}	max.	4	μs

prepared by:	AG	date of publication:	2016-11-25
approved by:	MS	revision:	3.5



Technische Information / technical information



Netz-Thyristor-Modul
Phase Control Thyristor Module

TZ740N

Infineon Technologies Bipolar
GmbH & Co. KG

Elektrische Eigenschaften / Electrical properties

Charakteristische Werte / Characteristic values

Freiwerdezeit circuit commutated turn-off time	$T_{vj} = T_{vj\ max}$, $i_{TM} = I_{TAVM}$ $V_{RM} = 100\ V$, $v_{DM} = 0,67\ V_{DRM}$ $dv_D/dt = 20\ V/\mu s$, $-di_T/dt = 10\ A/\mu s$ 5. Kennbuchstabe / 5 th letter O	t_q	typ.	350	μs
Isolations-Prüfspannung insulation test voltage	RMS, $f = 50\ Hz$, $t = 1\ min$ RMS, $f = 50\ Hz$, $t = 1\ sec$	V_{ISOL}		3,0 3,6	kV kV

Thermische Eigenschaften / Thermal properties

Innerer Wärmewiderstand thermal resistance, junction to case	pro Modul / per Module, $\Theta = 180^\circ\ sin$	R_{thJC}	max.	0,042	K/W
	pro Modul / per Module, DC		max.	0,0405	K/W
Übergangs-Wärmewiderstand thermal resistance, case to heatsink Übergangs-Wärmewiderstand mit TIM thermal resistance, case to heatsink, with TIM	pro Modul / per Module	R_{thCH}	max.	0,015	K/W
	pro Modul / per Module		max.	0,010	K/W
Höchstzulässige Sperrschichttemperatur maximum junction temperature		$T_{vj\ max}$		125	$^\circ C$
Betriebstemperatur operating temperature		$T_{c\ op}$		-40...+125	$^\circ C$
Lagertemperatur storage temperature Lagertemperatur mit TIM storage temperature with TIM		T_{stg}		-40...+125	$^\circ C$
				+5...+50	$^\circ C$

Mechanische Eigenschaften / Mechanical properties

Gehäuse, siehe Anlage case, see annex				Seite 4 page 4	
Si-Element mit Druckkontakt Si-pellet with pressure contact					
Innere Isolation internal insulation	Basisisolierung (Schutzklasse 1, EN61140) Basic insulation (class 1, IEC61140)			AIN	
Anzugsdrehmoment für mechanische Anschlüsse mounting torque	Toleranz / Tolerance $\pm 15\%$	M1		6	Nm
Anzugsdrehmoment für elektrische Anschlüsse terminal connection torque	Toleranz / Tolerance $\pm 10\%$	M2		18	Nm
Steueranschlüsse control terminals	DIN 46 244			A 2,8 x 0,8	
Gewicht weight		G	typ.	1950	g
Kriechstrecke creepage distance				36	mm
Schwingfestigkeit vibration resistance	$f = 50\ Hz$			50	m/s^2
	file-No.			E 83335	

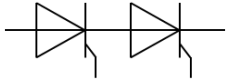

Technische Information /
technical information



Netz-Thyristor-Modul
Phase Control Thyristor Module

TZ740N

Infineon Technologies Bipolar
GmbH & Co. KG

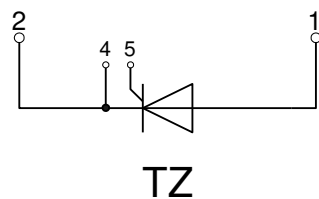
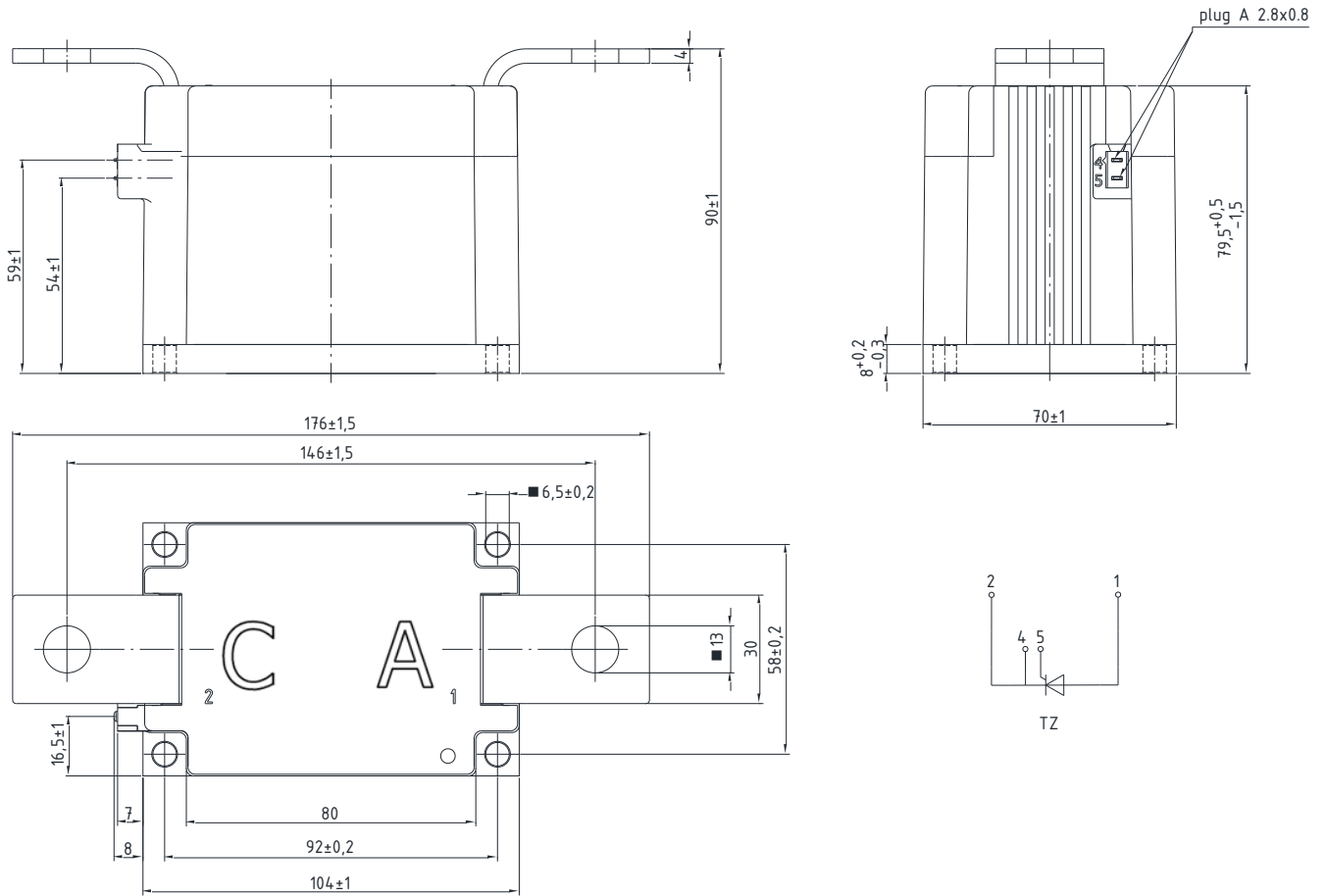



Technische Information /
technical information



Netz-Thyristor-Modul
Phase Control Thyristor Module

TZ740N

Infineon Technologies Bipolar
GmbH & Co. KG

Analytische Elemente des transienten Wärmewiderstandes Z_{thJC} für DC
Analytical elements of transient thermal impedance Z_{thJC} for DC

Pos. n	1	2	3	4	5	6	7
R_{thn} [K/W]	0,00507	0,02313	0,00866	0,00267	0,0011		
τ_n [s]	9,98	4,994	0,30347	0,0188	0,01		

Analytische Funktion / Analytical function:

$$Z_{thJC} = \sum_{n=1}^{n_{max}} R_{thn} \left(1 - e^{-\frac{t}{\tau_n}} \right)$$

Erhöhung des Z_{thDC} bei Sinus und Rechteckströmen mit unterschiedlichen Stromflusswinkeln Θ
Rise of Z_{thDC} for sinewave and rectangular current with different current conduction angles Θ
 $\Delta Z_{th\Theta rec} / \Delta Z_{th\Theta sin}$

	$\Theta = 180^\circ$	$\Theta = 120^\circ$	$\Theta = 90^\circ$	$\Theta = 60^\circ$	$\Theta = 30^\circ$
$\Delta Z_{th\Theta rec}$ [K/W]	0,00137	0,00196	0,00229	0,00265	0,00304
$\Delta Z_{th\Theta sin}$ [K/W]	0,00142	0,00175	0,00209	0,00248	0,00299

$$Z_{th\Theta rec} = Z_{thDC} + \Delta Z_{th\Theta rec}$$

$$Z_{th\Theta sin} = Z_{thDC} + \Delta Z_{th\Theta sin}$$

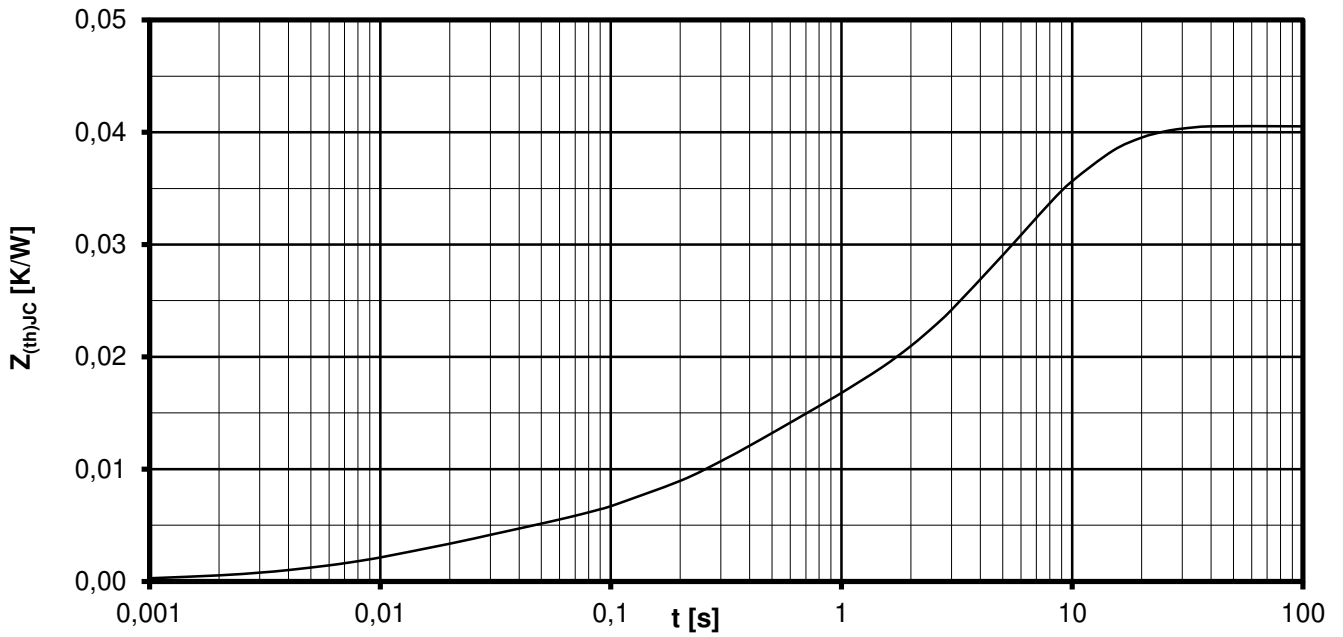
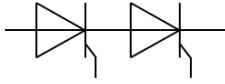

Transienter innerer Wärmewiderstand je Zweig / Transient thermal impedance per arm $Z_{thJC} = f(t)$

Parameter: Stromflußwinkel Θ / Current conduction angle Θ

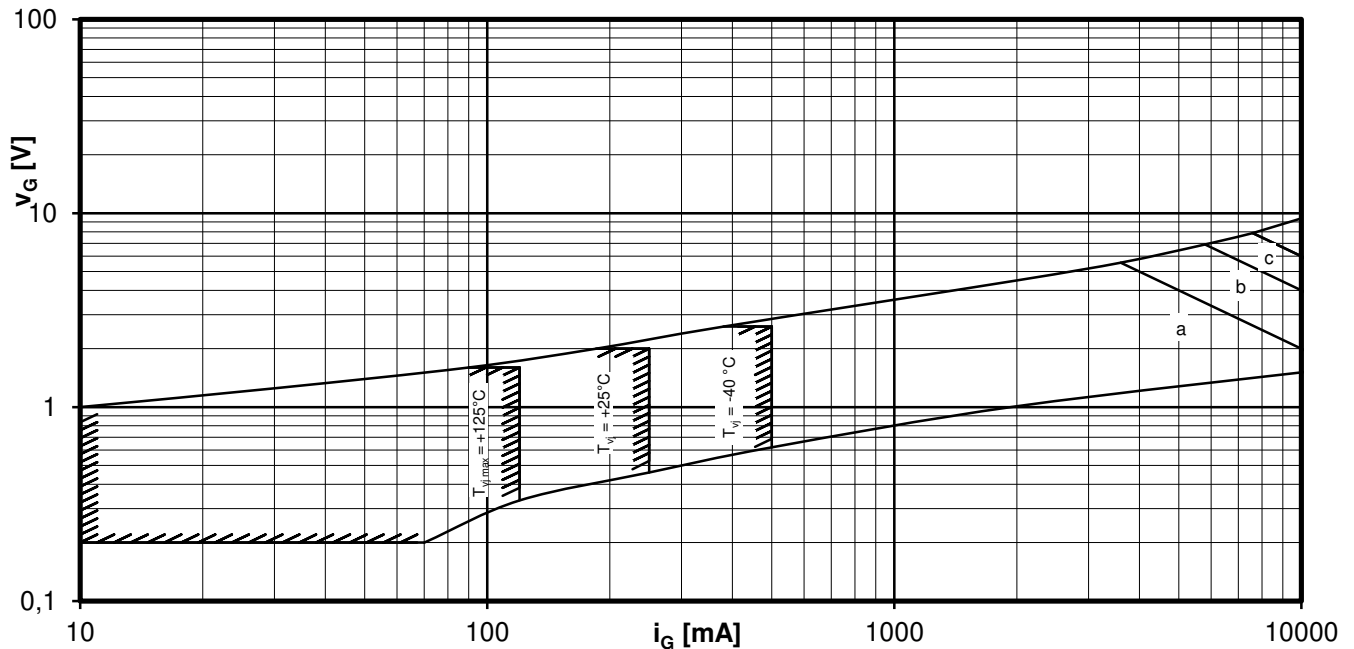

Steuercharakteristik $v_G = f(i_G)$ mit Zündbereichen für $V_D = 12\text{ V}$
Gate characteristic $v_G = f(i_G)$ with triggering area for $V_D = 12\text{ V}$

Höchstzulässige Spitzensteuerverlustleistung / Maximum rated peak gate power dissipation $P_{GM} = f(t_g)$:

a - 20W/10ms b - 40W/1ms c - 60W/0,5ms

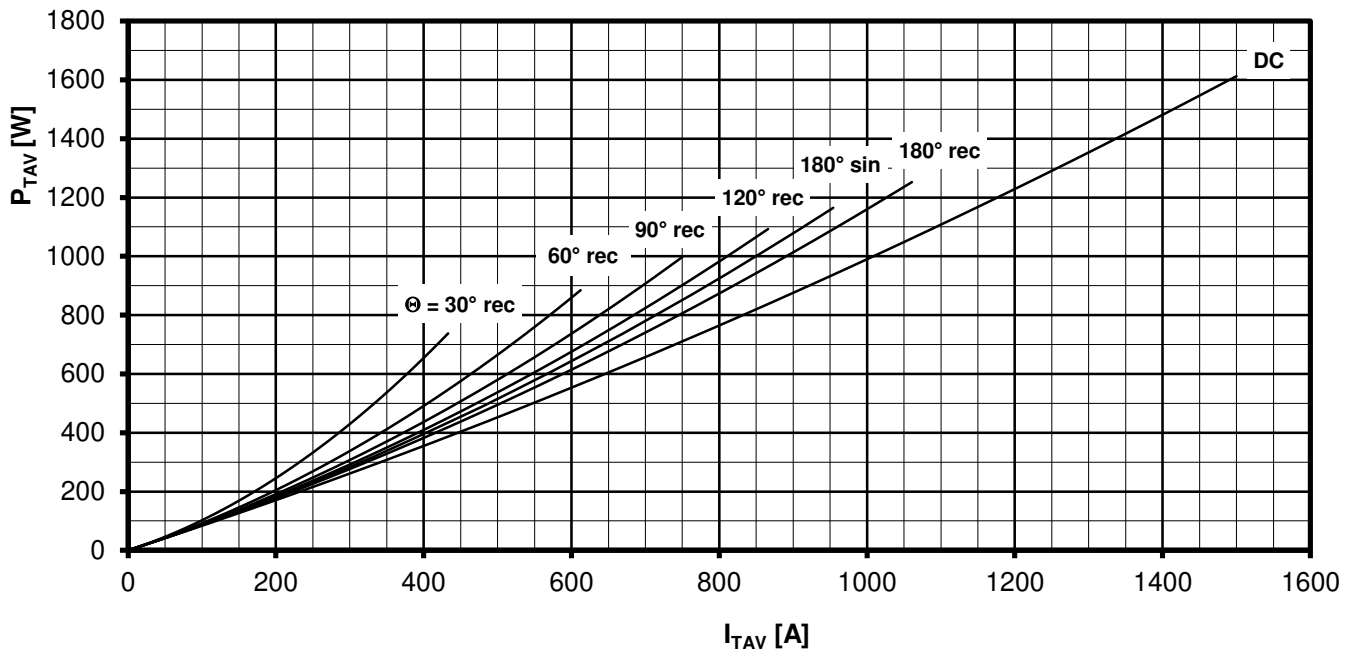

Durchlassverlustleistung je Zweig / On-state power loss per arm $P_{TAV} = f(I_{TAV})$

Strombelastung je Zweig / Current load per arm

Berechnungsgrundlage P_{TAV} (Schaltverluste gesondert berücksichtigen)
Calculation base P_{TAV} (switching losses should be considered separately)

Parameter: Stromflußwinkel / Current conduction angle Θ

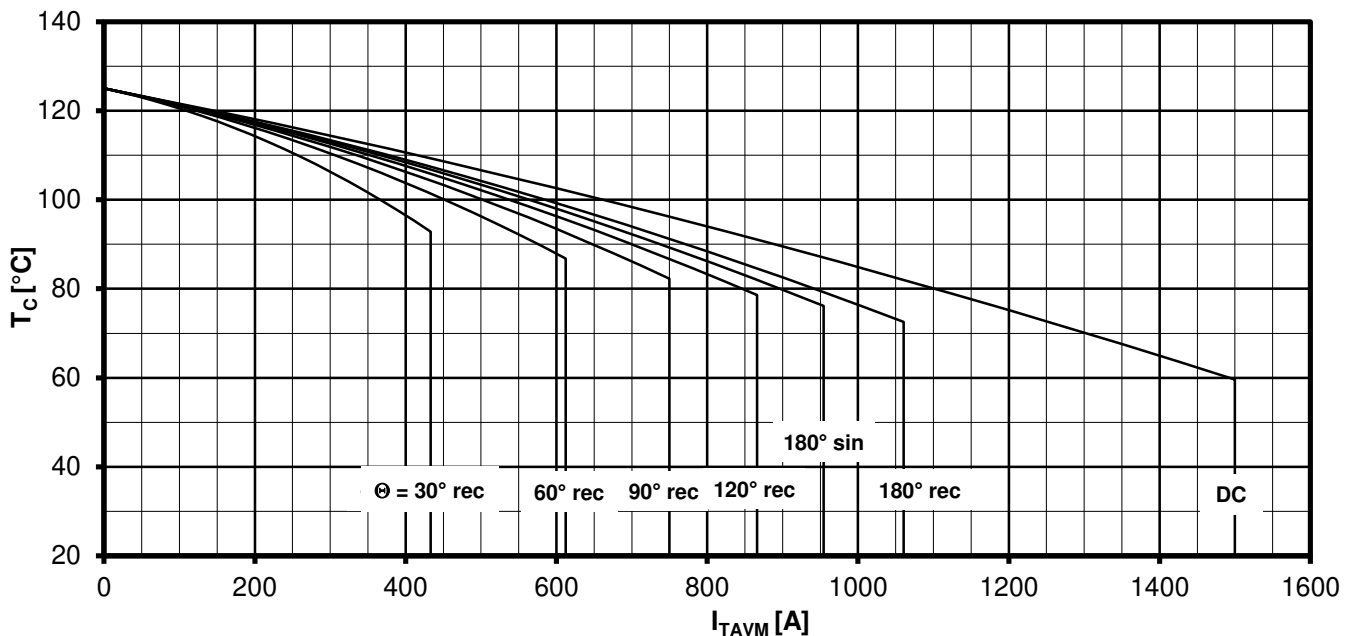

Höchstzulässige Gehäusetemperatur / Maximum allowable case temperature $T_C = f(I_{TAVM})$

Strombelastung je Zweig / Current load per arm

Berechnungsgrundlage P_{TAV} (Schaltverluste gesondert berücksichtigen)
Calculation base P_{TAV} (switching losses should be considered separately)

Parameter: Stromflußwinkel Θ / Current conduction angle Θ

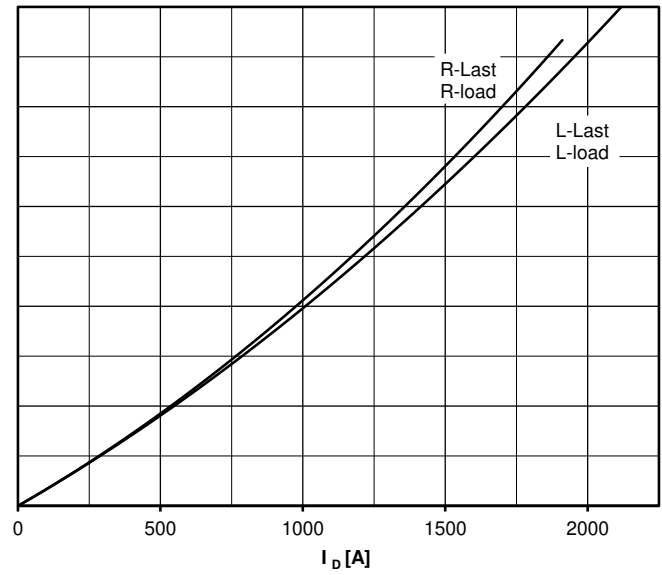
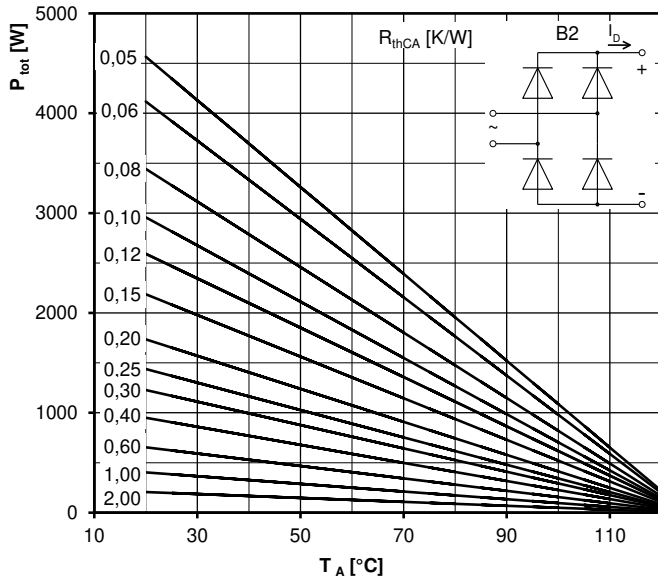

Höchstzulässiger Ausgangsstrom / Maximum rated output current I_D

B2- Zweipuls-Brückenschaltung / Two-pulse bridge circuit

Gesamtverlustleistung der Schaltung / Total power dissipation at circuit P_{tot}

Parameter:

Wärmewiderstand pro Element zwischen den Gehäusen und Umgebung /
Thermal resistance per chip cases to ambient R_{thCA}

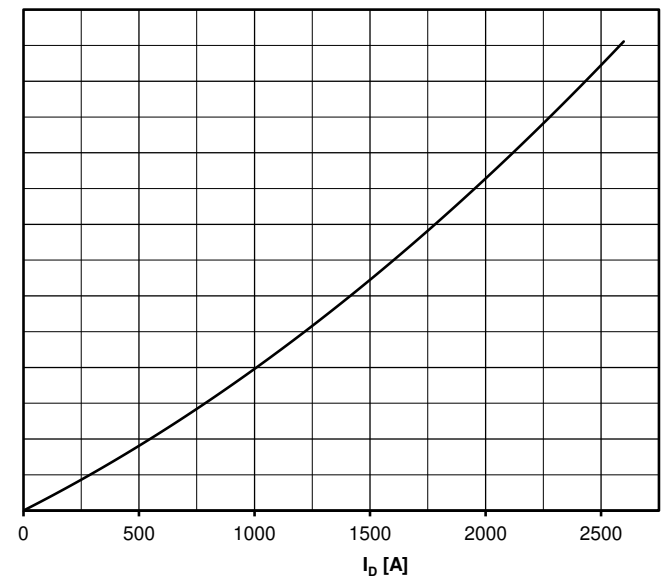
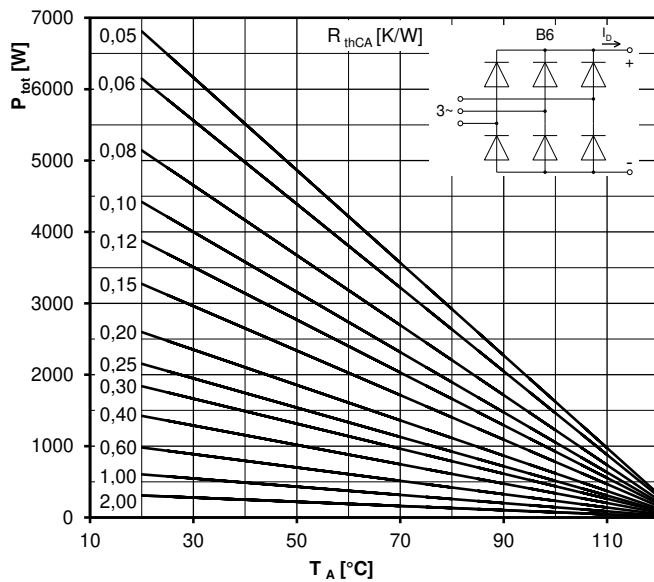

Höchstzulässiger Ausgangsstrom / Maximum rated output current I_D

B6- Sechspuls-Brückenschaltung / Six-pulse bridge circuit

Gesamtverlustleistung der Schaltung / Total power dissipation at circuit P_{tot}

Parameter:

Wärmewiderstand pro Element zwischen den Gehäusen und Umgebung /
Thermal resistance per chip cases to ambient R_{thCA}

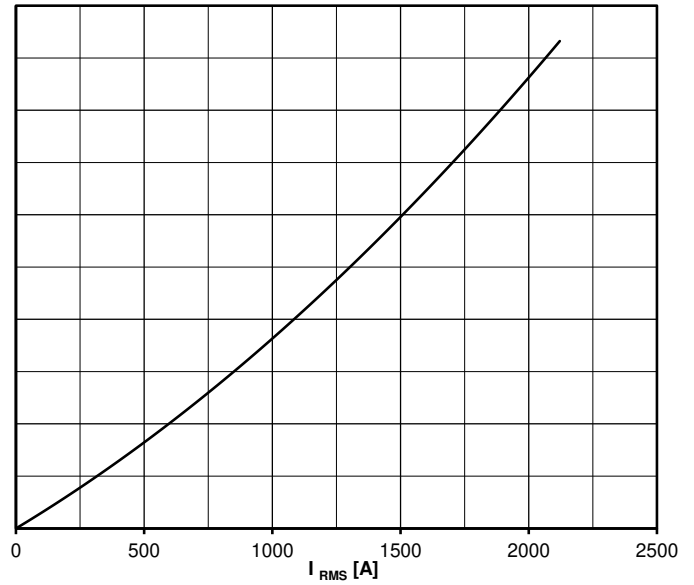
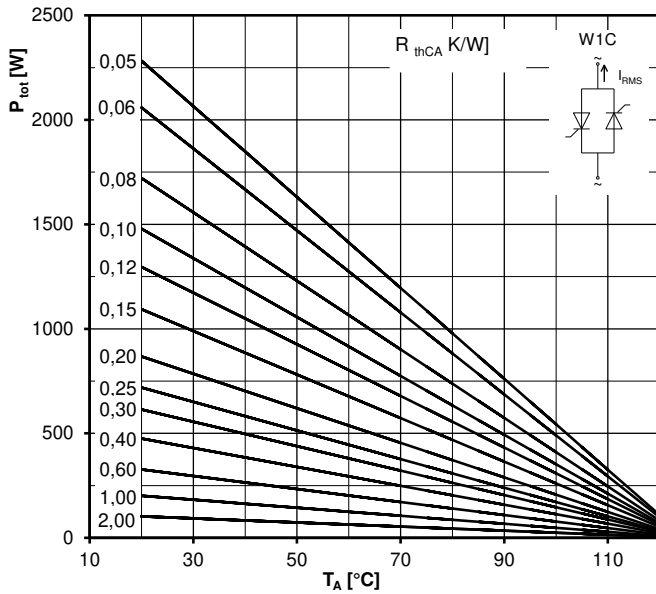

Höchstzulässiger Effektivstrom / Maximum rated RMS current I_{RMS}

W1C - Einphasen-Wechselwegschaltung / Single-phase inverse parallel circuit

Gesamtverlustleistung der Schaltung / Total power dissipation at circuit P_{tot}

Parameter:

Wärmewiderstand pro Element zwischen den Gehäusen und Umgebung /
Thermal resistance per chip cases to ambient R_{thCA}

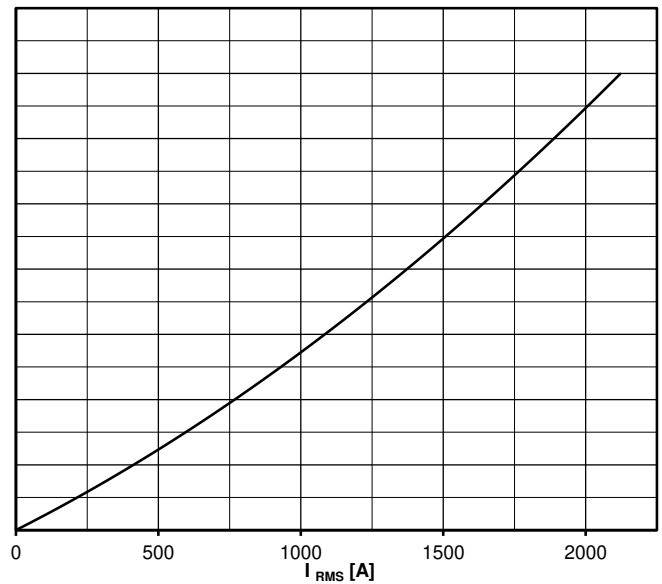
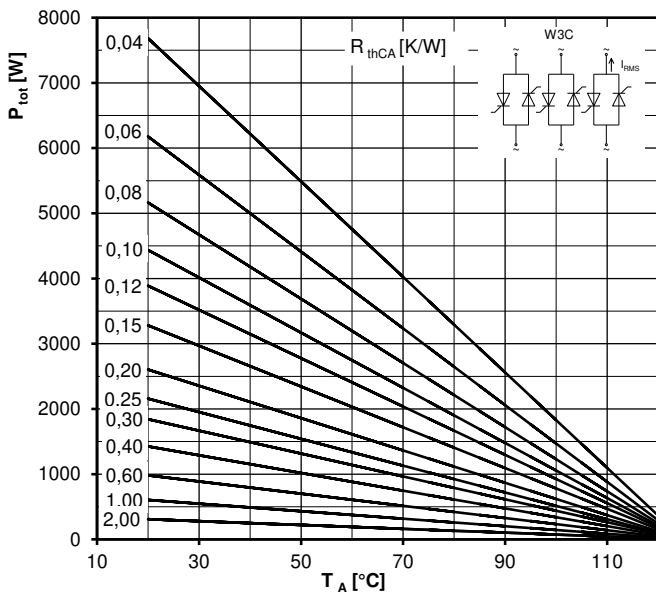

Höchstzulässiger Effektivstrom / Maximum rated RMS current I_{RMS}

W3C - Dreiphasen-Wechselwegschaltung / Three-phase inverse parallel circuit

Gesamtverlustleistung der Schaltung / Total power dissipation at circuit P_{tot}

Parameter:

Wärmewiderstand pro Element zwischen den Gehäusen und Umgebung /
Thermal resistance per chip cases to ambient R_{thCA}

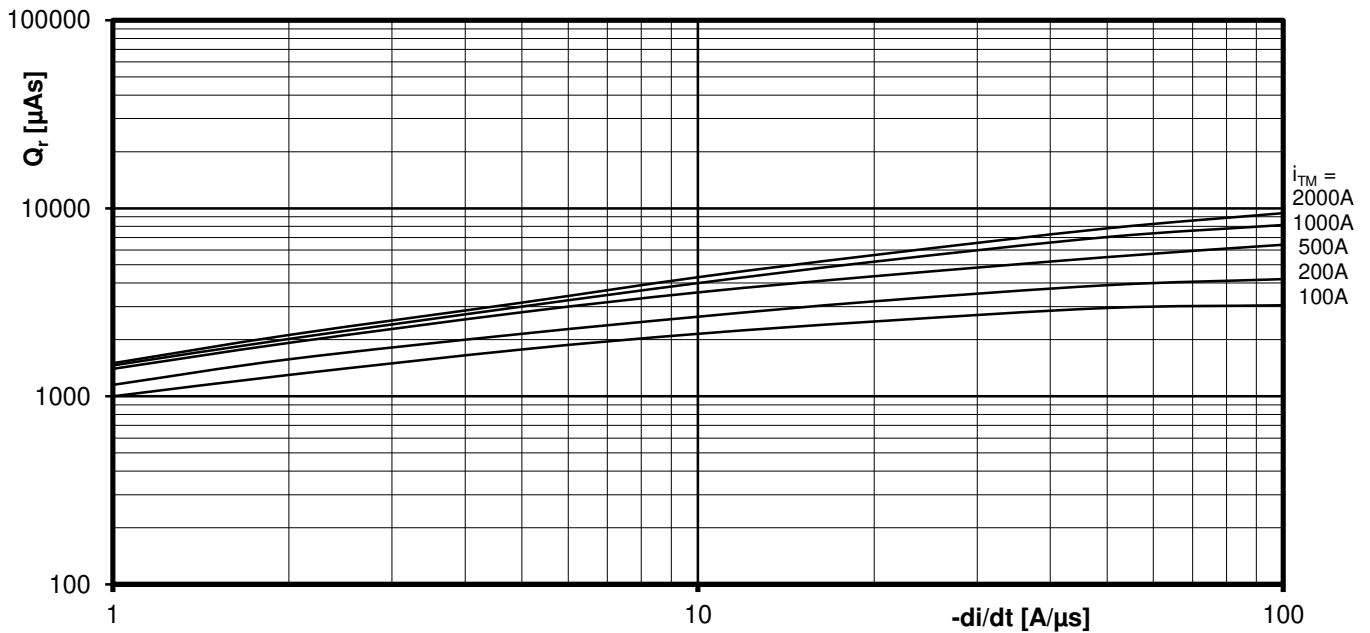

Sperrverzögerungsladung / Recovered charge $Q_r = f(-di/dt)$

$$T_{vj} = T_{vjmax}, v_R \leq 0,5 V_{RRM}, v_{RM} = 0,8 V_{RRM}$$

Parameter: Durchlaßstrom / On-state current i_{TM}

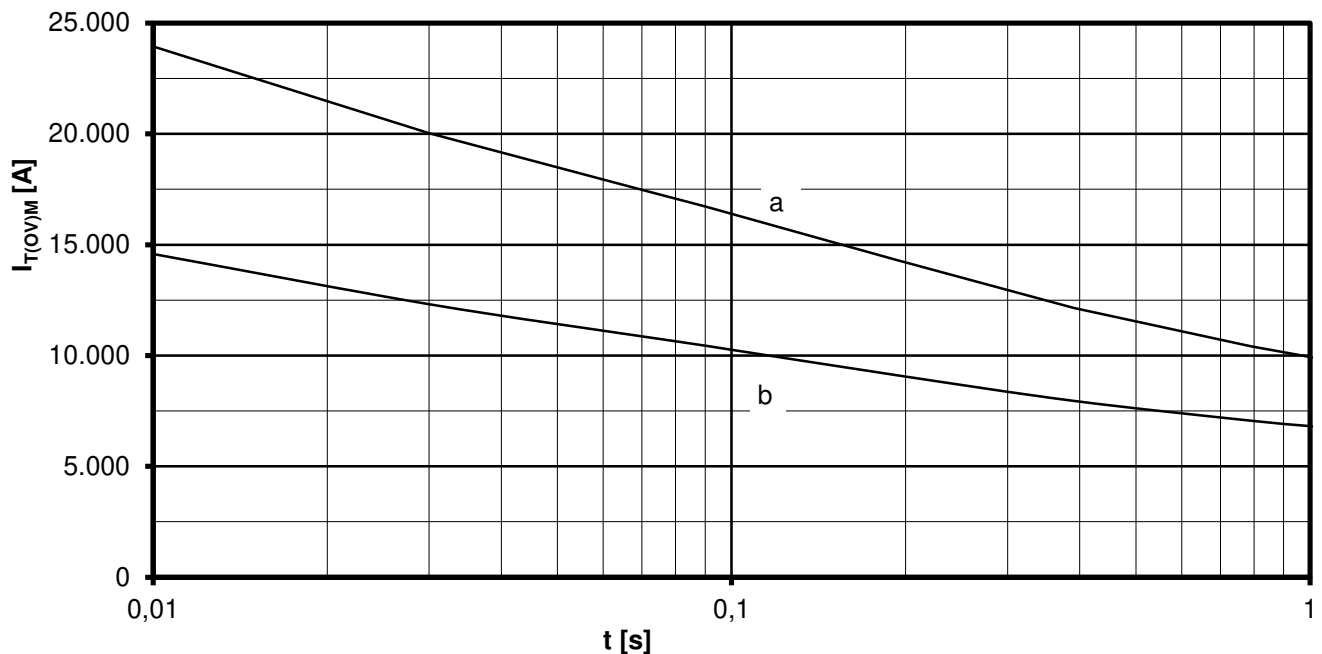

Grenzstrom / Maximum overload on-state current $I_{T(OV)M} = f(t), v_{RM} = 0,8 V_{RRM}$

a: Leerlauf / No-load conditions

b: nach Belastung mit I_{TAVM} / after load with I_{TAVM}

$T_A = 25^\circ\text{C}$, Wasserkühlung / water cooling



Nutzungsbedingungen

Die in diesem Produktdatenblatt enthaltenen Daten sind ausschließlich für technisch geschultes Fachpersonal bestimmt. Die Beurteilung der Eignung dieses Produktes für Ihre Anwendung sowie die Beurteilung der Vollständigkeit der bereitgestellten Produktdaten für diese Anwendung obliegt Ihnen bzw. Ihren technischen Abteilungen.

In diesem Produktdatenblatt werden diejenigen Merkmale beschrieben, für die wir eine liefervertragliche Gewährleistung übernehmen. Eine solche Gewährleistung richtet sich ausschließlich nach Maßgabe der im jeweiligen Liefervertrag enthaltenen Bestimmungen. Garantien jeglicher Art werden für das Produkt und dessen Eigenschaften keinesfalls übernommen.

Sollten Sie von uns Produktinformationen benötigen, die über den Inhalt dieses Produktdatenblatts hinausgehen und insbesondere eine spezifische Verwendung und den Einsatz dieses Produktes betreffen, setzen Sie sich bitte mit dem für Sie zuständigen Vertriebsbüro in Verbindung. Für Interessenten halten wir Application Notes bereit.

Aufgrund der technischen Anforderungen könnte unser Produkt gesundheitsgefährdende Substanzen enthalten. Bei Rückfragen zu den in diesem Produkt jeweils enthaltenen Substanzen setzen Sie sich bitte ebenfalls mit dem für Sie zuständigen Vertriebsbüro in Verbindung.

Sollten Sie beabsichtigen, das Produkt in gesundheits- oder lebensgefährdenden oder lebenserhaltenden Anwendungsbereichen einzusetzen, bitten wir um Mitteilung. Wir weisen darauf hin, dass wir für diese Fälle

- die gemeinsame Durchführung eines Risiko- und Qualitätsassessments;
- den Abschluss von speziellen Qualitätssicherungsvereinbarungen;
- die gemeinsame Einführung von Maßnahmen einer laufenden Produktbeobachtung dringend empfehlen und gegebenenfalls die Belieferung von der Umsetzung solcher Maßnahmen abhängig machen.

Soweit erforderlich, bitten wir Sie, entsprechende Hinweise an Ihre Kunden zu geben.

Inhaltliche Änderungen dieses Produktdatenblatts bleiben vorbehalten.

Terms & Conditions of usage

The product data contained in this product data sheet is exclusively intended for technically trained staff. You and your technical departments will have to evaluate the suitability of the product for the intended application and the completeness of the product data with respect to such application.

This product data sheet is describing the specifications of this product for which a warranty is granted. Any such warranty is granted exclusively pursuant the terms and conditions of the supply agreement. There will be no guarantee of any kind for the product and its specifications.

Should you require product information in excess of the data given in this product data sheet or which concerns the specific application of our product, please contact the sales office, which is responsible for you. For those that are specifically interested we may provide application notes.

Due to technical requirements our product may contain dangerous substances. For information on the types in question please contact the sales office, which is responsible for you.

Should you intend to use the Product in health or live endangering or life support applications, please notify. Please note, that for any such applications we urgently recommend

- to perform joint Risk and Quality Assessments;
- the conclusion of Quality Agreements;
- to establish joint measures of an ongoing product survey, and that we may make delivery depended on the realization of any such measures.

If and to the extent necessary, please forward equivalent notices to your customers.

Changes of this product data sheet are reserved.