



Chipsmall Limited consists of a professional team with an average of over 10 year of expertise in the distribution of electronic components. Based in Hongkong, we have already established firm and mutual-benefit business relationships with customers from,Europe,America and south Asia,supplying obsolete and hard-to-find components to meet their specific needs.

With the principle of “Quality Parts,Customers Priority,Honest Operation,and Considerate Service”,our business mainly focus on the distribution of electronic components. Line cards we deal with include Microchip,ALPS,ROHM,Xilinx,Pulse,ON,Everlight and Freescale. Main products comprise IC,Modules,Potentiometer,IC Socket,Relay,Connector.Our parts cover such applications as commercial,industrial, and automotives areas.

We are looking forward to setting up business relationship with you and hope to provide you with the best service and solution. Let us make a better world for our industry!



Contact us

Tel: +86-755-8981 8866 Fax: +86-755-8427 6832

Email & Skype: info@chipsmall.com Web: www.chipsmall.com

Address: A1208, Overseas Decoration Building, #122 Zhenhua RD., Futian, Shenzhen, China



30 GHz Broadband Amplifier Module

Features

- 23 dBm saturated output power
- 30 dB gain
- 2.7 W power dissipation
- Small size package

Description

The UA0L30VM Amplifier is a general-purpose broadband amplifier designed for microwave communications, test equipment, and military systems. Its small size and exceptional performance make it a versatile gain block which can improve power and gain in a single hermetically sealed package potentially replacing 2 or 3 narrower band amplifiers.

The UA0L30VM provides a complete amplifier module package with a wide frequency range of 100 kHz to 30 GHz, low power dissipation, ample output power, low noise figure and gain control. The UA0L30VM complies with the ESDS Component Sensitivity Classification 1B per ESD STM5.1-1998.

Application

- mm-wave systems
- High frequency test instrumentation
- Broadband gain amplifier

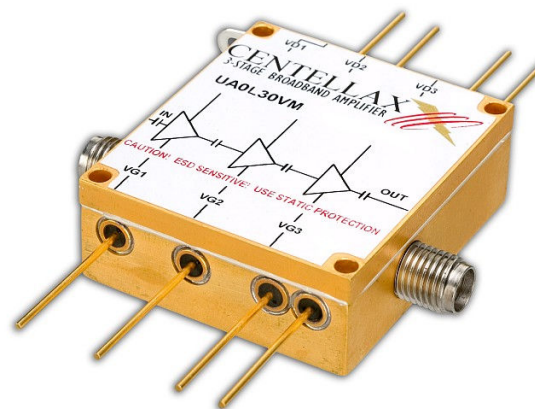

Key Characteristics: (Specifications pertain to case temperature range 0 to +75°C)
 $V_{d1}=V_{d2}=V_{d3}=7V \pm 5\%$, $V_{g1}=V_{g2}= -0.15V$, $V_{g3}= -0.05V$; $Z_o=50\Omega$

Parameter	Description	100kHz - 30GHz		
		Min	Typ	Max
S21 (dB)	Small Signal Gain	27	30	-
S11 (dB)	Input Match	-	-15	-10
S22 (dB)	Output Match	-	-15	-10

* $V_{g1}/V_{g2}/V_{g3}$ adjusted for peak gm

Typical Performance

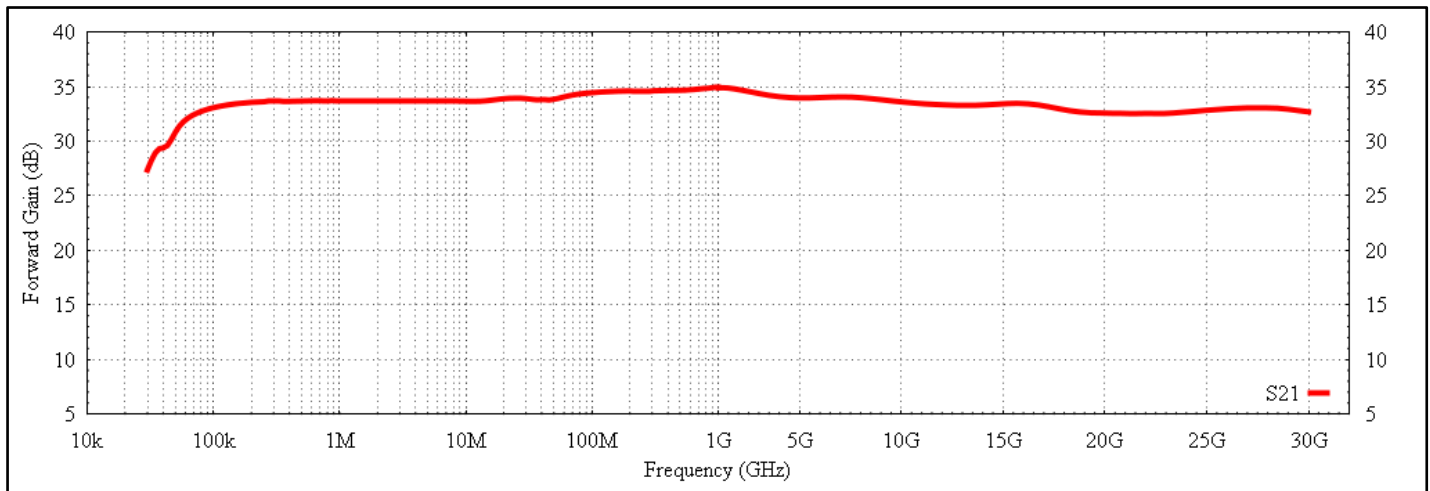

Small Signal, forward gain (S21) vs. Frequency

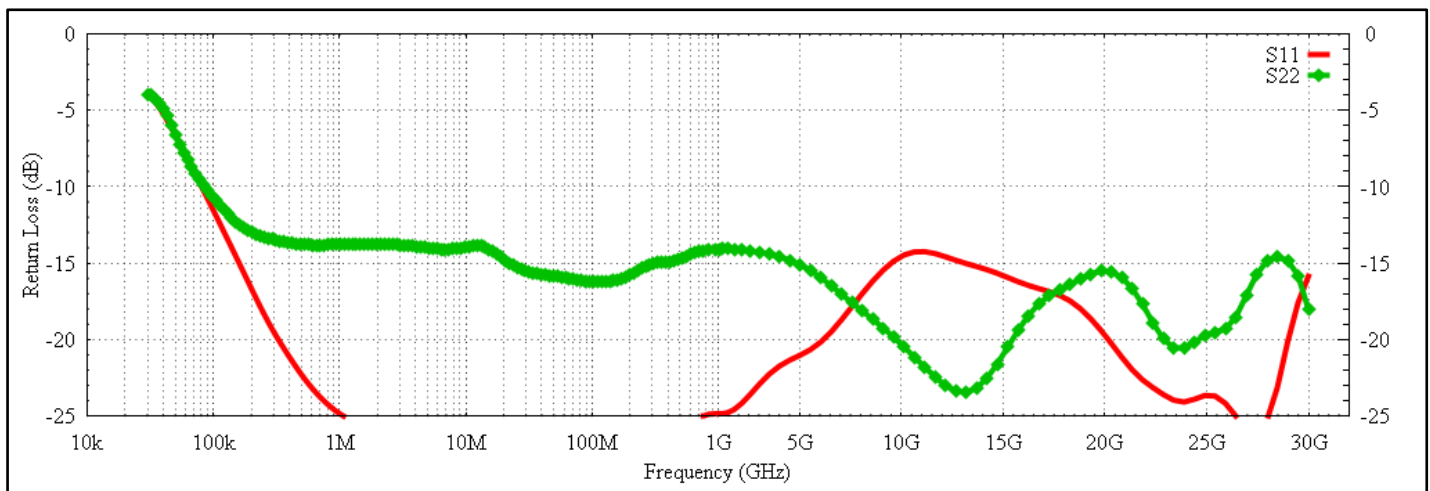

Small signal, input (S11) & output return (S22) loss vs. Frequency

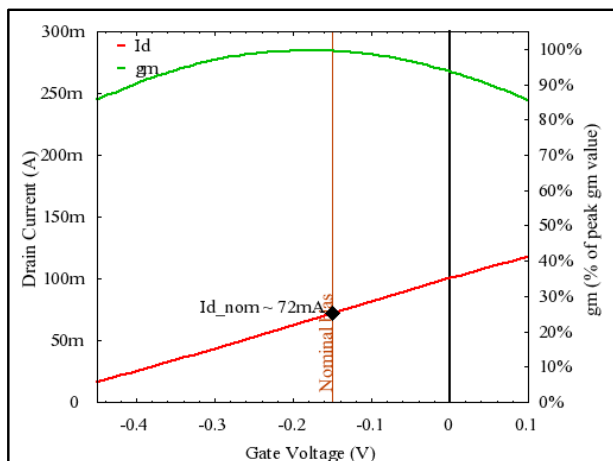

Drain Current and gm vs. Gate Voltage 1st and 2nd amplifier stages

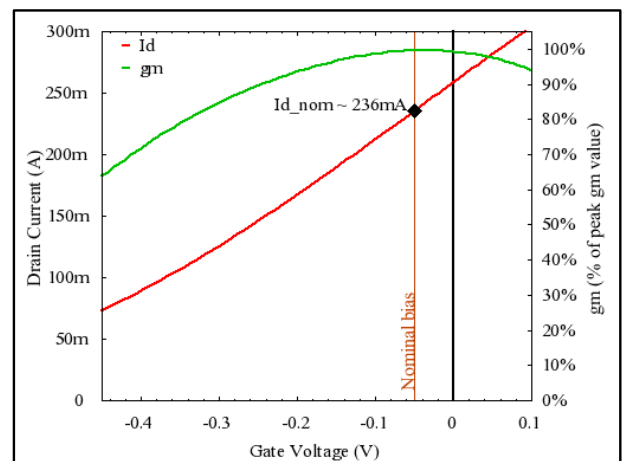

Drain Current and gm vs. Gate Voltage 3rd amplifier stage

Typical Performance

Two Tone Performance @ 20 GHz
Delta frequency = 1MHz

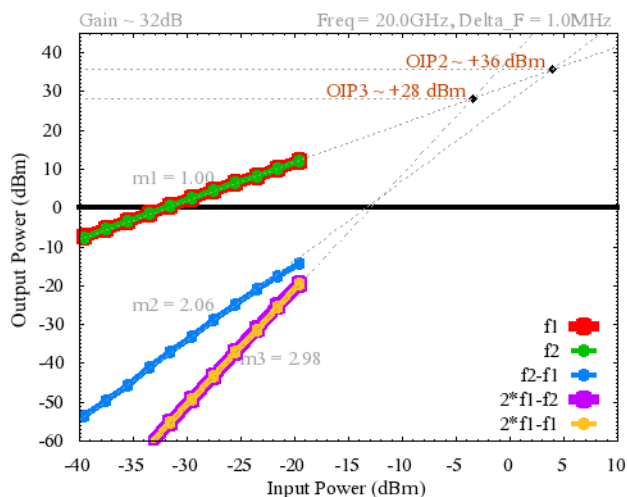

Absolute Maximum Ratings*

Parameter	Description	Minimum	Maximum
Vd1 (V)	First Drain Voltage	-	9
Vd2 (V)	Second Drain Voltage	-	9
Vd3 (V)	Third Drain Voltage	-	9
Id1 (mA)	First Drain Current	-	250
Id3 (mA)	Second Drain Current	-	250
Id3 (mA)	Third Drain Current	-	400
Vg1 (V)	First Gate Voltage	-1.5	1
Vg2 (V)	Second Gate Voltage	-1.5	1
Vg3 (V)	Third Gate Voltage	-1.5	1
Storage Temperature (C)		-55	125
Operating Case Temperature (C)		-25	85
Lead Soldering** (C)		-	260° for 3 sec.
RF Input Power (dBm)		-	20
RF connector torque requirement (in-lb)		-	8

Recommended Operating Bias

Noise Figure vs. Frequency

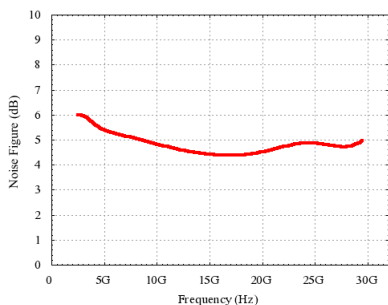

P1db and Psat vs. Frequency

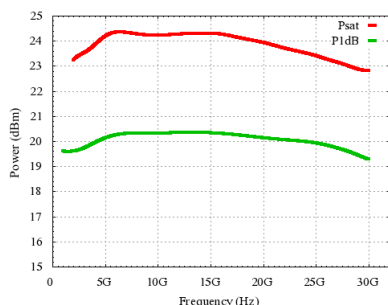

Parameter	Typical
Vd1=7V, Vg1= -0.15V	Id1=72mA
Vd2=7V, Vg2= -0.15V	Id2=72mA
Vd3=7V, Vg3= -0.05	Id3=236mA
Power Dissipation	2.7W
Id3 (mA)	Second Drain Current
Id3 (mA)	Third Drain Current

*Operation beyond the values listed under the Absolute Maximum Ratings may cause permanent damage to the device. These are stress ratings only, and functional operation of the device at these or any other conditions beyond those indicated in the recommended Operating Bias is not implied. Prolonged use at the absolute maximum rating conditions may affect device reliability.

**The use of a heat sink between the component body and the solder joint is highly recommended.

Physical Dimensions and Pin Assignment

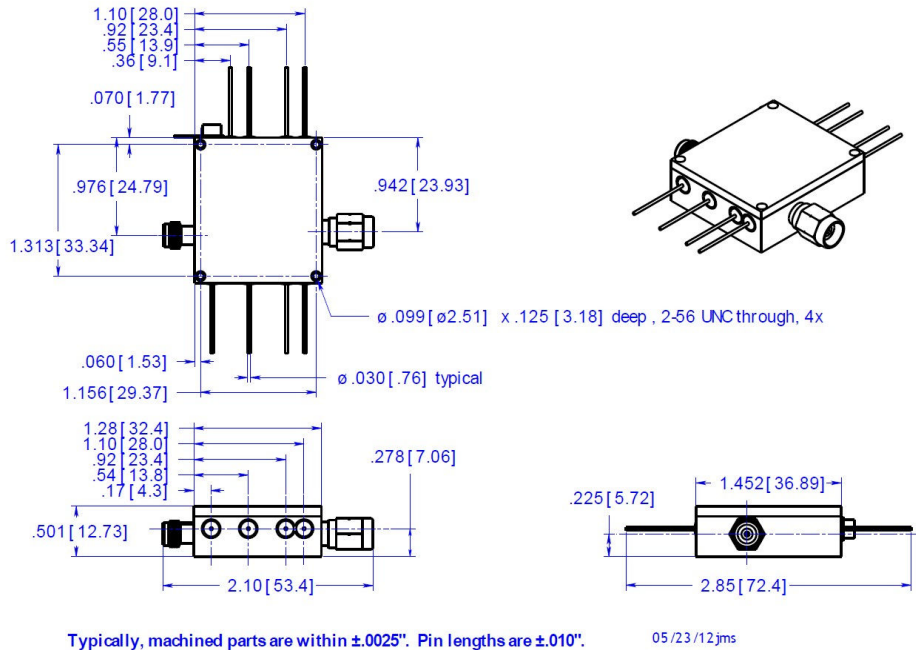

Physical Characteristics

(all measurements in inches[mm])

Tolerance typically
 ± 0.0025 in
 (+/- 0.0635mm)

DC pin diameter is
 0.03in [0.76mm]

Table 1: UA0L30VM Pin Definition

Pin	Function	Operational Notes
RFin	RF Input	2.92mm Connector (f) standard
RFout	RF Output	2.92mm Connector (f) standard
1 (Vg1)	1st stage gate bias	Adjust for optimum gain
2 (Vg2)	2nd stage gate bias	Adjust for optimum gain
3 (Vg3)	3rd stage gate bias	Adjust for optimum gain
4	NC	Not Connected
5 (Vd1)	1st stage drain bias	Set at typical operating specification
6 (Vd2)	2nd stage drain bias	Set at typical operating specification
7 (Vd3)	3rd stage drain bias	Set at typical operating specification
8	NC	Not Connected

Bias Recommendations (in order):

1) Set gate bias to recommended values; 2) Apply Bias Drains; 3) Adjust bias for optimum gain (maximum gm)

Versatile Bias Board (TE1B) Available.

Please visit our website for more information

Information contained in this document is proprietary to Microsemi. This document may not be modified in any way without the express written consent of Microsemi. Product processing does not necessarily include testing of all parameters. Microsemi reserves the right to change the configuration and performance of the product and to discontinue product at any time.

Microsemi Corporate Headquarters

One Enterprise, Aliso Viejo CA 92656 USA
Within the USA: +1 (949) 380-6100
Sales: +1 (949) 380-6136
Fax: +1 (949) 215-4996

Microsemi Corporation (Nasdaq: MSCC) offers a comprehensive portfolio of semiconductor and system solutions for communications, defense and security, aerospace, and industrial markets. Products include high-performance and radiation-hardened analog mixed-signal integrated circuits, FPGAs, SoCs, and ASICs; power management products; timing and synchronization devices and precise time solutions, setting the world's standard for time; voice processing devices; RF solutions; discrete components; security technologies and scalable anti-tamper products; Power-over-Ethernet ICs and midspans; as well as custom design capabilities and services. Microsemi is headquartered in Aliso Viejo, Calif. and has approximately 3,400 employees globally. Learn more at www.microsemi.com.

© 2014 Microsemi Corporation. All rights reserved. Microsemi and the Microsemi logo are trademarks of Microsemi Corporation. All other trademarks and service marks are the property of their respective owners.