



Chipsmall Limited consists of a professional team with an average of over 10 year of expertise in the distribution of electronic components. Based in Hongkong, we have already established firm and mutual-benefit business relationships with customers from,Europe,America and south Asia,supplying obsolete and hard-to-find components to meet their specific needs.

With the principle of “Quality Parts,Customers Priority,Honest Operation,and Considerate Service”,our business mainly focus on the distribution of electronic components. Line cards we deal with include Microchip,ALPS,ROHM,Xilinx,Pulse,ON,Everlight and Freescale. Main products comprise IC,Modules,Potentiometer,IC Socket,Relay,Connector.Our parts cover such applications as commercial,industrial, and automotives areas.

We are looking forward to setting up business relationship with you and hope to provide you with the best service and solution. Let us make a better world for our industry!



Contact us

Tel: +86-755-8981 8866 Fax: +86-755-8427 6832

Email & Skype: info@chipsmall.com Web: www.chipsmall.com

Address: A1208, Overseas Decoration Building, #122 Zhenhua RD., Futian, Shenzhen, China



PROTECTION PRODUCTS - MicroClamp™
Description

The μClamp™ series of TVS arrays are designed to protect sensitive electronics from damage or latch-up due to ESD. It is designed to replace multilayer varistors (MLVs) in portable applications such as cell phones, notebook computers, and PDAs. It features large cross-sectional area junctions for conducting high transient currents. It offers superior electrical characteristics such as lower clamping voltage and no device degradation when compared to MLVs. They offer desirable characteristics for board level protection including fast response time, low operating and clamping voltage, and no device degradation.

The μClamp™0501P is in a 2-pin, RoHS/WEEE compliant, SLP1006P2 package. It measures 1.0 x 0.6 x 0.5mm. The leads are spaced at a pitch of 0.65mm and are finished with lead-free NiPdAu. Each device will protect one line operating at 5 volts. It gives the designer the flexibility to protect single lines in applications where arrays are not practical. They may be used to meet the ESD immunity requirements of IEC 61000-4-2, Level 4 (±15kV air, ±8kV contact discharge). The combination of small size and high ESD surge capability makes them ideal for use in portable applications such as cellular phones, digital cameras, and MP3 players.

Features

- ◆ Transient protection for data lines to **IEC 61000-4-2 (ESD) ±15kV (air), ±8kV (contact) IEC 61000-4-4 (EFT) 40A (tp = 5/50ns) Cable Discharge Event (CDE)**
- ◆ Ultra-small package (1.0 x 0.6 x 0.5mm)
- ◆ Protects one I/O or power line
- ◆ Low clamping voltage
- ◆ Working voltage: 5V
- ◆ Low leakage current
- ◆ Solid-state silicon-avalanche technology

Mechanical Characteristics

- ◆ SLP1006P2 package
- ◆ RoHS/WEEE Compliant
- ◆ Nominal Dimensions: 1.0 x 0.6 x 0.5 mm
- ◆ Lead Finish: NiPdAu
- ◆ Molding compound flammability rating: UL 94V-0
- ◆ Marking : Marking code, cathode band
- ◆ Packaging : Tape and Reel

Applications

- ◆ Cellular Handsets & Accessories
- ◆ Personal Digital Assistants (PDAs)
- ◆ Notebooks & Handhelds
- ◆ Portable Instrumentation
- ◆ Digital Cameras
- ◆ Peripherals
- ◆ MP3 Players

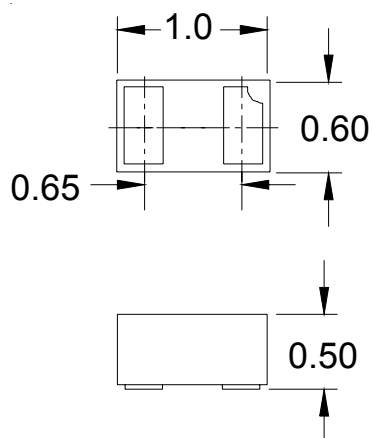
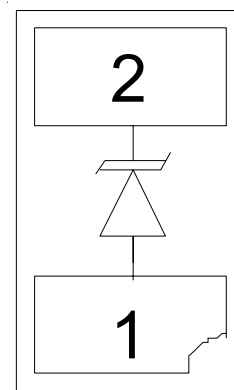
Dimensions

Nominal Dimensions (mm)
Schematic & PIN Configuration

SLP1006P2 (Bottom View)

PROTECTION PRODUCTS
Absolute Maximum Rating

Rating	Symbol	Value	Units
Peak Pulse Power (tp = 8/20μs)	P_{pk}	200	Watts
Maximum Peak Pulse Current (tp = 8/20μs)	I_{pp}	16	Amps
ESD per IEC 61000-4-2 (Air) ESD per IEC 61000-4-2 (Contact)	V_{ESD}	+/- 20 +/- 15	kV
Operating Temperature	T_J	-55 to +125	°C
Storage Temperature	T_{STG}	-55 to +150	°C

Electrical Characteristics (T=25°C)

Parameter	Symbol	Conditions	Minimum	Typical	Maximum	Units
Reverse Stand-Off Voltage	V_{RWM}				5	V
Reverse Breakdown Voltage	V_{BR}	$I_t = 1mA$	6			V
Reverse Leakage Current	I_R	$V_{RWM} = 5V, T=25°C$			5	μA
Forward Voltage	V_F	$I_F = 10mA$		0.80		V
Clamping Voltage	V_C	$I_{pp} = 5A, t_p = 8/20μs$			9.8	V
Clamping Voltage	V_C	$I_{pp} = 16A, t_p = 8/20μs$			12.5	V
Junction Capacitance	C_j	$V_R = 0V, f = 1MHz$			160	pF

PROTECTION PRODUCTS

Typical Characteristics

Non-Repetitive Peak Pulse Power vs. Pulse Time

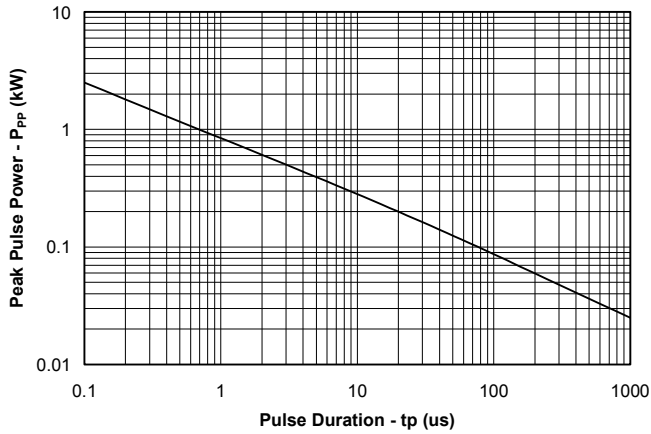

Power Derating Curve

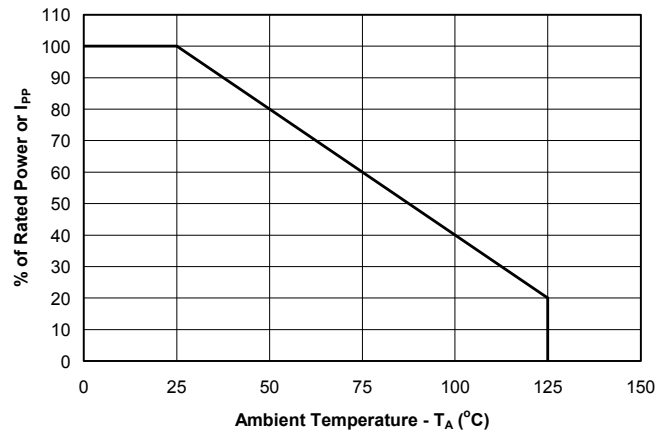

Clamping Voltage vs. Peak Pulse Current

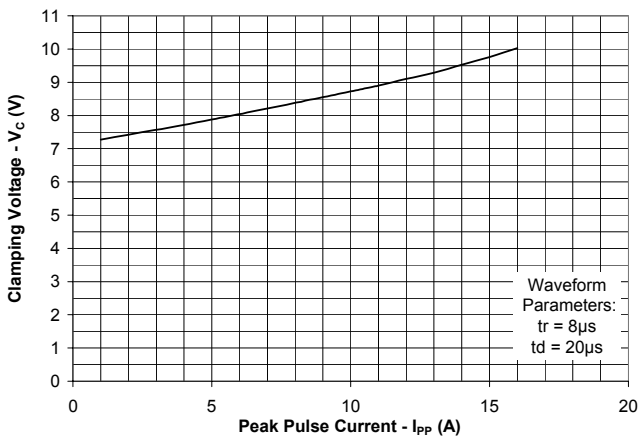

Forward Voltage vs. Forward Current

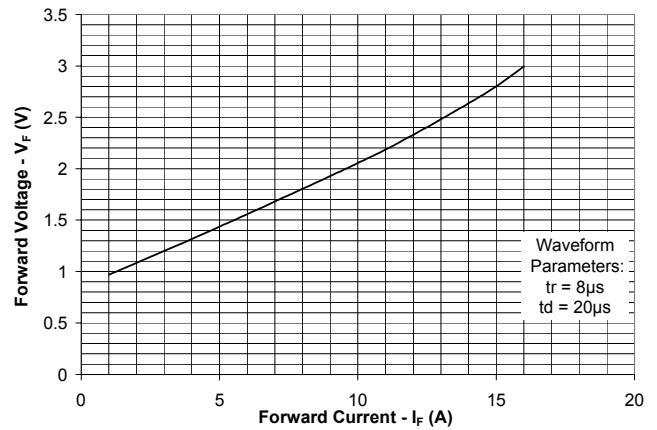

Normalized Capacitance vs. Reverse Voltage

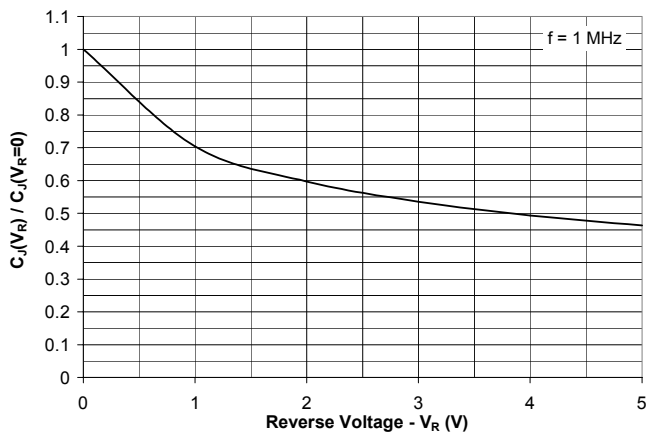

ESD Clamping (8kV Contact per IEC 61000-4-2)

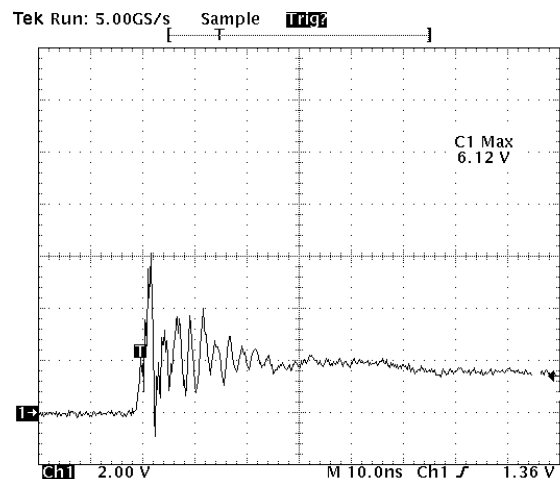

Note: Data is taken with a 10x attenuator

PROTECTION PRODUCTS**Applications Information****Device Connection Options**

These TVS diodes are designed to protect one data, I/O, or power supply line. The device is unidirectional and may be used on lines where the signal polarity is above ground. The cathode band should be placed towards the line that is to be protected.

Circuit Board Layout Recommendations for Suppression of ESD.

Good circuit board layout is critical for the suppression of ESD induced transients. The following guidelines are recommended:

- Place the TVS near the input terminals or connectors to restrict transient coupling.
- Minimize the path length between the TVS and the protected line.
- Minimize all conductive loops including power and ground loops.
- The ESD transient return path to ground should be kept as short as possible.
- Never run critical signals near board edges.
- Use ground planes whenever possible.

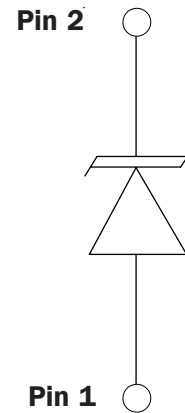
Circuit Diagram

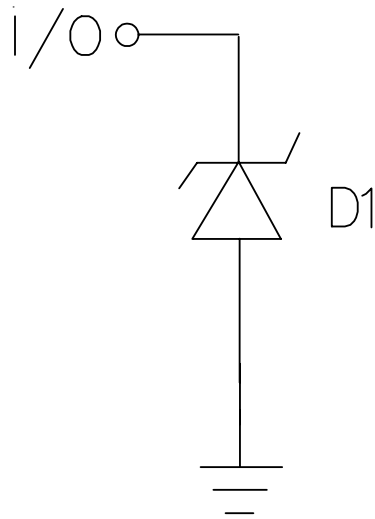
PROTECTION PRODUCTS
Applications Information - Spice Model

uClamp0501P Spice Model

uClamp0501P Spice Parameters		
Parameter	Unit	D1 (TVS)
IS	Amp	2.53e-12
BV	Volt	7.08
VJ	Volt	0.71
RS	Ohm	0.129
IBV	Amp	1.0E-3
CJO	Farad	143.5e-12
TT	sec	2.541E-9
M	--	0.385
N	--	1.1
EG	eV	1.11

PROTECTION PRODUCTS

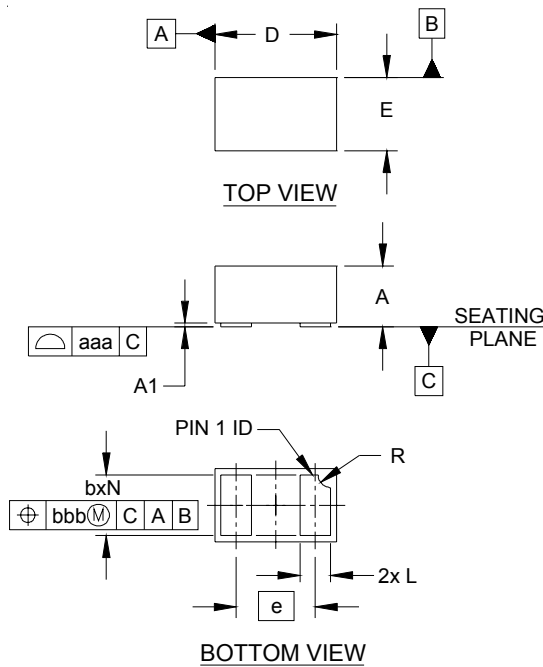
Outline Drawing - SLP1006P2



DIM	INCHES			MILLIMETERS		
	MIN	NOM	MAX	MIN	NOM	MAX
A	.016	.020	.022	0.40	0.50	0.55
A1	.000	.001	.002	0.00	0.03	0.05
b	.018	.020	.022	0.45	0.50	0.55
D	.035	.039	.043	0.90	1.00	1.10
E	.020	.024	.028	0.50	0.60	0.70
e	.026 BSC			0.65 BSC		
L	.008	.010	.012	0.20	0.25	0.30
R	.002	.004	.006	0.05	0.10	0.15
N	2			2		
aaa	.003			0.08		
bbb	.004			0.10		

NOTES:

1. CONTROLLING DIMENSIONS ARE IN MILLIMETERS (ANGLES IN DEGREES).

Land Pattern - SLP1006P2

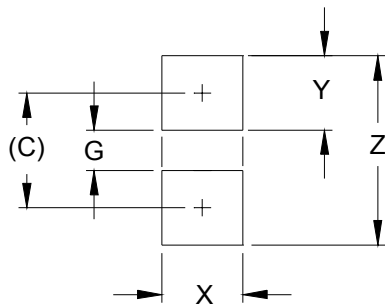

DIM	DIMENSIONS	
	INCHES	MILLIMETERS
C	(.033)	(0.85)
G	.012	0.30
X	.024	0.60
Y	.022	0.55
Z	.055	1.40

NOTES:

1. CONTROLLING DIMENSIONS ARE IN MILLIMETERS (ANGLES IN DEGREES).
2. THIS LAND PATTERN IS FOR REFERENCE PURPOSES ONLY. CONSULT YOUR MANUFACTURING GROUP TO ENSURE YOUR COMPANY'S MANUFACTURING GUIDELINES ARE MET.

PROTECTION PRODUCTS

Marking Code

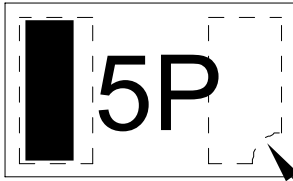

PIN 1 ID

Note: Cathode bar at Pin 2

Ordering Information

Part Number	Working Voltage	Qty per Reel	Reel Size
uClamp0501P.TCT	5V	3,000	7 Inch

Notes:

1) This is a lead-free, RoHS/WEEE compliant product
MicroClamp, uClamp and μ Clamp are marks of Semtech Corporation

Tape and Reel Specification

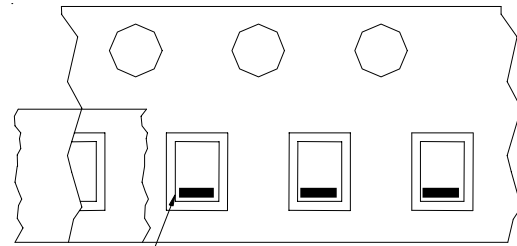
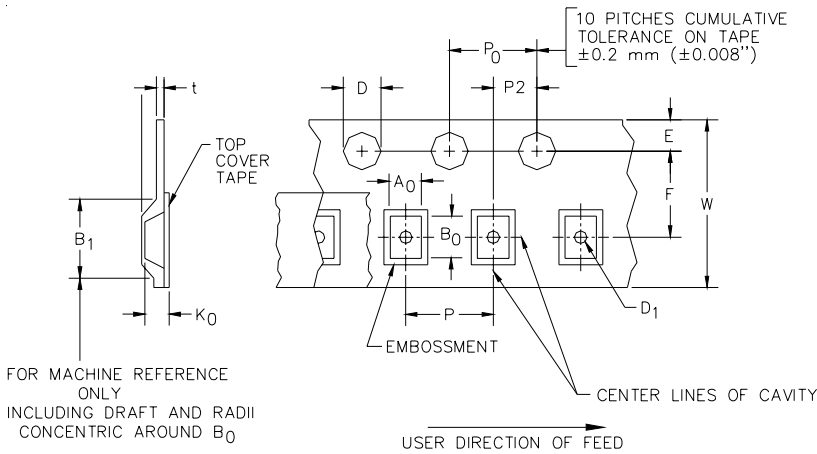

Cathode Bar

User Direction of feed

Device Orientation in Tape

A0	B0	K0
0.69 +/-0.10 mm	1.19 +/-0.10 mm	0.66 +/-0.10 mm

Tape Width	B, (Max)	D	D1	E	F	P	P0	P2	T	W
8 mm	4.2 mm (.165)	1.5 + 0.1 mm - 0.0 mm (0.59 +0.05 - .000)	0.4 mm ±0.25 (.031)	1.750±.10 mm (.069±.004)	3.5±0.05 mm (.138±.002)	4.0±0.10 mm (.157±.00-4)	4.0±0.1 mm (.157±.00-4)	2.0±0.05 mm (.079±.002)	0.254±0.02 mm (.016)	8.0 mm + 0.3 mm - 0.1 mm (.312±.012)

Contact Information

Semtech Corporation
Protection Products Division
200 Flynn Rd., Camarillo, CA 93012
Phone: (805)498-2111 FAX (805)498-3804