



Chipsmall Limited consists of a professional team with an average of over 10 year of expertise in the distribution of electronic components. Based in Hongkong, we have already established firm and mutual-benefit business relationships with customers from,Europe,America and south Asia,supplying obsolete and hard-to-find components to meet their specific needs.

With the principle of “Quality Parts,Customers Priority,Honest Operation,and Considerate Service”,our business mainly focus on the distribution of electronic components. Line cards we deal with include Microchip,ALPS,ROHM,Xilinx,Pulse,ON,Everlight and Freescale. Main products comprise IC,Modules,Potentiometer,IC Socket,Relay,Connector.Our parts cover such applications as commercial,industrial, and automotives areas.

We are looking forward to setting up business relationship with you and hope to provide you with the best service and solution. Let us make a better world for our industry!



## Contact us

Tel: +86-755-8981 8866 Fax: +86-755-8427 6832

Email & Skype: info@chipsmall.com Web: www.chipsmall.com

Address: A1208, Overseas Decoration Building, #122 Zhenhua RD., Futian, Shenzhen, China



### PROTECTION PRODUCTS - MicroClamp™

#### Description

The  $\mu$ Clamp™ series of Transient Voltage Suppressors (TVS) are designed to replace multilayer varistors (MLVs) in portable applications such as cell phones, notebook computers, and PDAs. They offer superior electrical characteristics such as lower clamping voltage and no device degradation when compared to MLVs. They are designed to protect sensitive semiconductor components from damage or upset due to electrostatic discharge (ESD), lightning, electrical fast transients (EFT), and cable discharge events (CDE).

The  $\mu$ Clamp™3301D is constructed using Semtech's proprietary EPD process technology. The EPD process provides low standoff voltages with significant reductions in leakage currents and capacitance over silicon-avalanche diode processes. They feature a true operating voltage of 3.3 volts for superior protection when compared to traditional pn junction devices.

The  $\mu$ Clamp3301D is in a SOD-323 package and will protect one unidirectional line. They give the designer the flexibility to protect one line in applications where arrays are not practical.

They may be used to meet the ESD immunity requirements of IEC 61000-4-2, Level 4 ( $\pm 15\text{kV}$  air,  $\pm 8\text{kV}$  contact discharge).

#### Features

- ◆ 100 Watts peak pulse power ( $t_p = 8/20\mu\text{s}$ )
- ◆ Transient protection for data lines to  
**IEC 61000-4-2 (ESD)  $\pm 15\text{kV}$  (air),  $\pm 8\text{kV}$  (contact)**  
**IEC 61000-4-4 (EFT) 40A ( $t_p = 5/50\text{ns}$ )**  
**IEC 61000-4-5 (Lightning) 10A ( $t_p = 8/20\mu\text{s}$ )**
- ◆ Small package for use in portable electronics
- ◆ Suitable replacement for MLVs in ESD protection applications
- ◆ Protects one line
- ◆ Low clamping voltage
- ◆ Working voltages: **3.3V**
- ◆ Low leakage current
- ◆ Solid-state silicon-avalanche technology

#### Mechanical Characteristics

- ◆ EIAJ SOD-323 package
- ◆ Molding compound flammability rating: UL 94V-0
- ◆ Marking: Marking code, cathode band
- ◆ Packaging: Tape and Reel
- ◆ Lead Finish: Matte tin
- ◆ RoHS/WEEE Compliant

#### Applications

- ◆ Cell Phone Handsets and Accessories
- ◆ Laser Diode Protection
- ◆ Notebooks, Desktops, & Servers
- ◆ Portable Instrumentation
- ◆ Analog Inputs

#### Equivalent Circuit Diagram

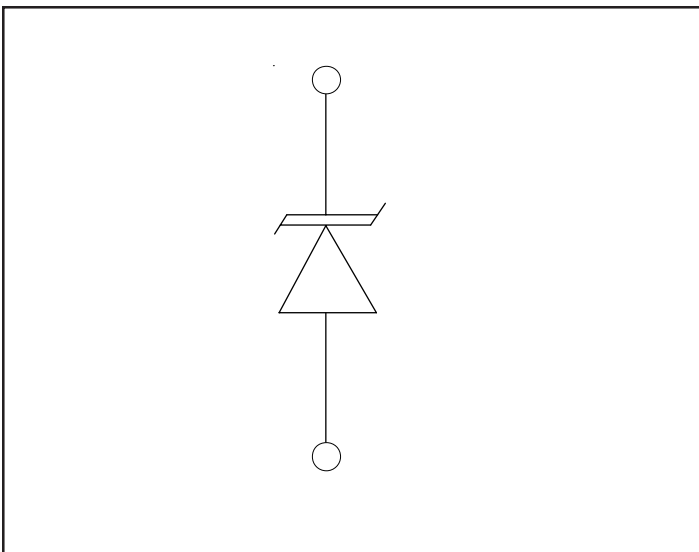

#### Schematic & PIN Configuration

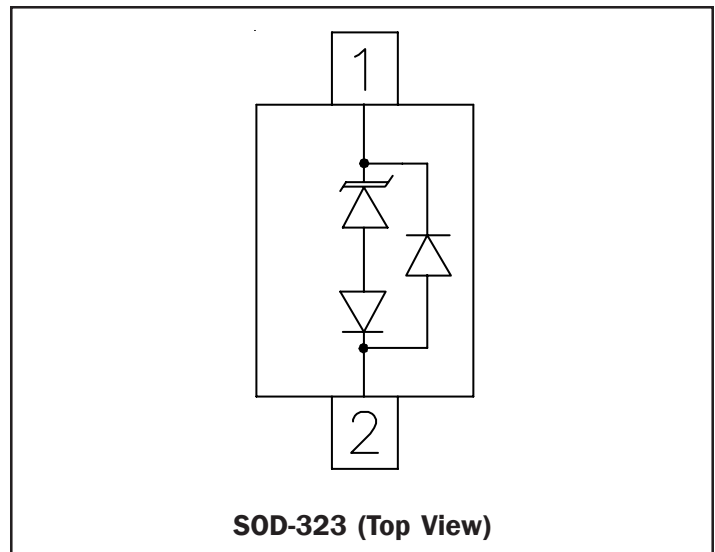

**PROTECTION PRODUCTS**
**Absolute Maximum Rating**

Rating	Symbol	Value	Units
Peak Pulse Power (tp = 8/20μs)	$P_{pk}$	100	Watts
Peak Pulse Current (tp = 8/20μs)	$I_{pp}$	10	A
ESD Voltage (HBM Waveform per IEC 61000-4-2)	$V_{pp}$	30	kV
Operating Temperature	$T_J$	-55 to +125	°C
Storage Temperature	$T_{STG}$	-55 to +150	°C

**Electrical Characteristics**

Parameter	Symbol	Conditions	Minimum	Typical	Maximum	Units
Reverse Stand-Off Voltage	$V_{RWM}$				3.3	V
Punch-Through Voltage	$V_{PT}$	$I_{PT} = 2\mu A$	3.5			V
Snap-Back Voltage	$V_{SB}$	$I_{SB} = 50mA$	2.8			V
Reverse Leakage Current	$I_R$	$V_{RWM} = 3.3V, T=25^\circ C$			0.5	μA
Clamping Voltage	$V_C$	$I_{pp} = 1A, tp = 8/20\mu s$ Pin 1 to 2			4.5	V
Clamping Voltage	$V_C$	$I_{pp} = 5A, tp = 8/20\mu s$ Pin 1 to 2			5.5	V
Clamping Voltage	$V_C$	$I_{pp} = 10A, tp = 8/20\mu s$ Pin 1 to 2			9.5	V
Steering Diode Forward Voltage (Reverse Clamping Voltage)	$V_F$	$I_{pp} = 1A, tp = 8/20\mu s$ Pin 2 to 1			1.8	V
Junction Capacitance	$C_J$	$V_R = 0V, f = 1MHz$			50	pF



PROTECTION PRODUCTS

Typical Characteristics

Non-Repetitive Peak Pulse Power vs. Pulse Time

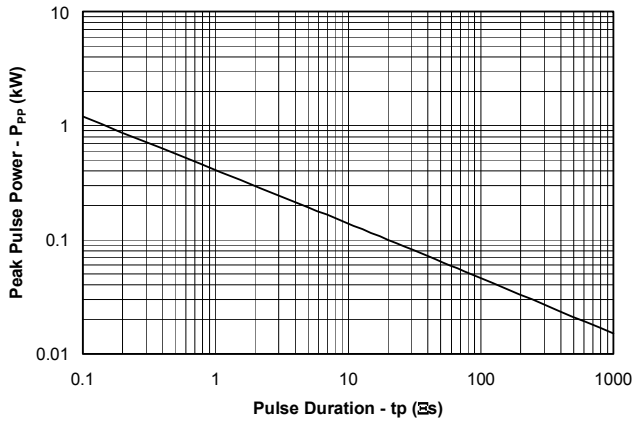

Power Derating Curve

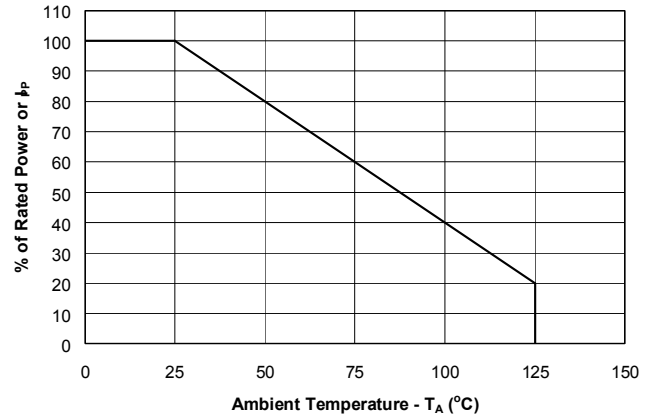

Clamping Voltage vs. Peak Pulse Current

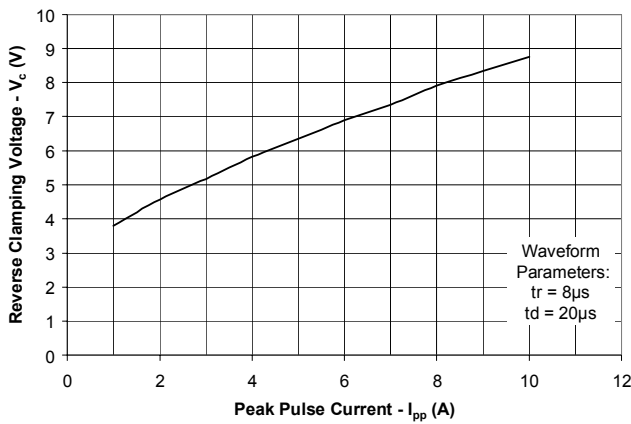

Normalized Capacitance vs. Reverse Voltage

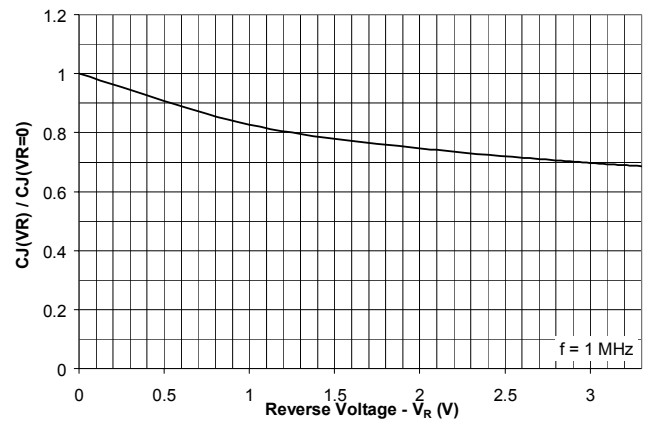

Insertion Loss S21

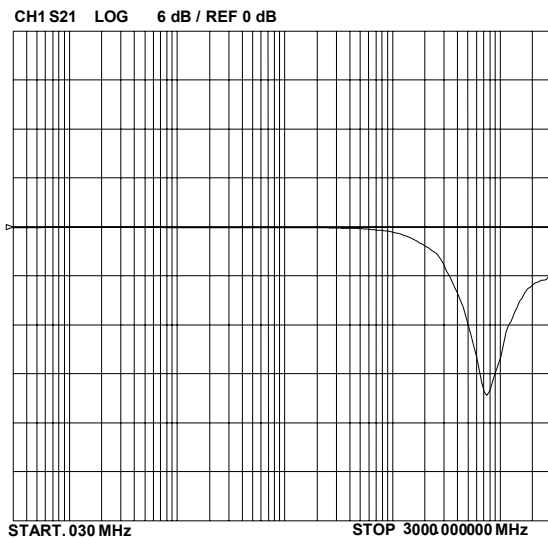

## PROTECTION PRODUCTS

### Applications Information

#### Device Connection Options

The μClamp3301D is designed to protect one I/O, or power supply line. It will present a high impedance to the protected line up to 3.3 volts. It will “turn on” when the line voltage exceeds 3.5 volts. The device is unidirectional and may be used on lines where the signal polarity is above ground. The cathode band should be placed towards the line that is to be protected.

Due to the “snap-back” characteristics of the low voltage TVS, it is not recommended that the I/O line be directly connected to a DC source greater than snap-back voltage ( $V_{SB}$ ) as the device can latch on as described below.

#### EPD TVS Characteristics

The μClamp3301D is constructed using Semtech’s proprietary EPD technology. The structure of the EPD TVS is vastly different from the traditional pn-junction devices. At voltages below 5V, high leakage current and junction capacitance render conventional avalanche technology impractical for most applications. However, by utilizing the EPD technology, the μClamp3301D can effectively operate at 3.3V while maintaining excellent electrical characteristics.

The EPD TVS employs a complex nppn structure in contrast to the pn structure normally found in traditional silicon-avalanche TVS diodes. Since the EPD TVS devices use a 4-layer structure, they exhibit a slightly different IV characteristic curve when compared to conventional devices. During normal operation, the device represents a high-impedance to the circuit up to the device working voltage ( $V_{RWM}$ ). During an ESD event, the device will begin to conduct and will enter a low impedance state when the punch through voltage ( $V_{PT}$ ) is exceeded. Unlike a conventional device, the low voltage TVS will exhibit a slight negative resistance characteristic as it conducts current. This characteristic aids in lowering the clamping voltage of the device, but must be considered in applications where DC voltages are present.

When the TVS is conducting current, it will exhibit a slight “snap-back” or negative resistance characteristics due to its structures. This point is defined on the curve by the snap-back voltage ( $V_{SB}$ ) and snap-back

#### Device Schematic & Pin Configuration

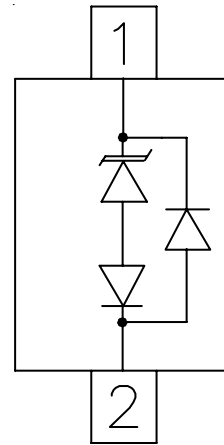

#### EPD TVS IV Characteristic Curve

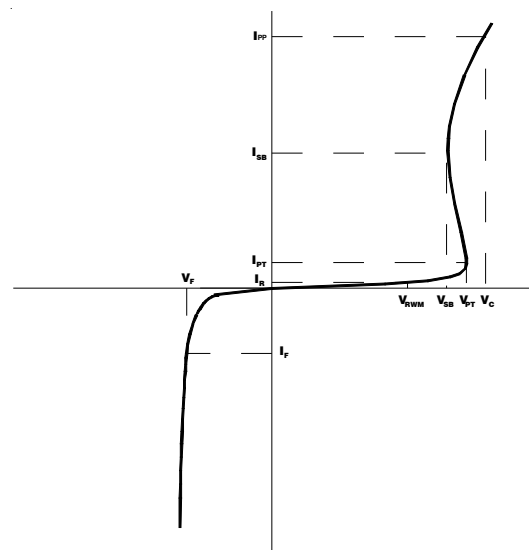

current ( $I_{SB}$ ). To return to a non-conducting state, the current through the device must fall below the  $I_{SB}$  (approximately <50mA) and the voltage must fall below the  $V_{SB}$  (normally 2.8 volts for a 3.3V device). If a 3.3V TVS is connected to 3.3V DC source, it will never fall below the snap-back voltage of 2.8V and will therefore stay in a conducting state.

PROTECTION PRODUCTS

Outline Drawing - SOD-323

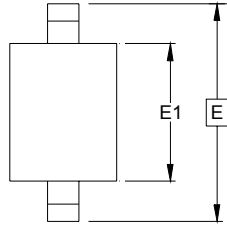

DIM	DIMENSIONS					
	INCHES			MILLIMETERS		
	MIN	NOM	MAX	MIN	NOM	MAX
A	0.36	-	.046	0.91	-	1.17
A1	.000	-	.004	0.00	-	0.10
A2	.012	-	.016	0.30	-	0.40
b	.013	-	.017	0.33	-	0.43
c	.005	-	.008	0.13	-	0.20
D	.044	.050	.054	1.18	1.28	1.37
E1	.060	.065	.070	1.50	1.64	1.78
E	.097	.102	.107	2.46	2.59	2.72
L	.010	.014	.018	0.25	0.35	0.45
N	2			2		

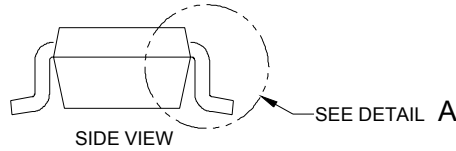
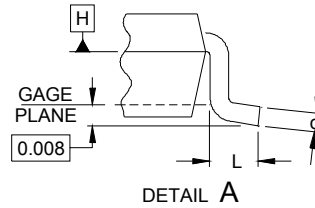
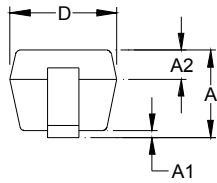

NOTES:

1. CONTROLLING DIMENSIONS ARE IN INCHES (ANGLES IN DEGREES).
2. DIMENSIONS "E1" AND "D" DO NOT INCLUDE MOLD FLASH, PROTRUSIONS OR GATE BURRS.

Land Pattern - SOD-323

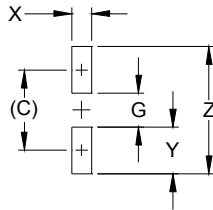

DIM	DIMENSIONS	
	INCHES	MILLIMETERS
C	(.085)	(2.15)
G	.035	0.90
X	.021	0.53
Y	.049	1.25
Z	.134	3.40

NOTES:

1. THIS LAND PATTERN IS FOR REFERENCE PURPOSES ONLY. CONSULT YOUR MANUFACTURING GROUP TO ENSURE YOUR COMPANY'S MANUFACTURING GUIDELINES ARE MET.

PROTECTION PRODUCTS

Marking Code

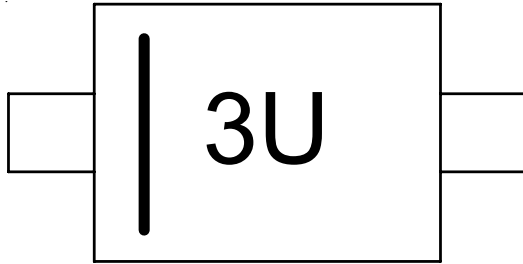

Ordering Information

Part Number	Working Voltage	Qty per Reel	Reel Size
uClamp3301D.TCT	3.3V	3,000	7"

MicroClamp, uClamp, and  $\mu$ Clamp are marks of Semtech Corporation

Contact Information

Semtech Corporation  
Protection Products Division  
200 Flynn Rd., Camarillo, CA 93012  
Phone: (805)498-2111 FAX (805)498-3804