



Chipsmall Limited consists of a professional team with an average of over 10 year of expertise in the distribution of electronic components. Based in Hongkong, we have already established firm and mutual-benefit business relationships with customers from,Europe,America and south Asia,supplying obsolete and hard-to-find components to meet their specific needs.

With the principle of “Quality Parts,Customers Priority,Honest Operation,and Considerate Service”,our business mainly focus on the distribution of electronic components. Line cards we deal with include Microchip,ALPS,ROHM,Xilinx,Pulse,ON,Everlight and Freescale. Main products comprise IC,Modules,Potentiometer,IC Socket,Relay,Connector.Our parts cover such applications as commercial,industrial, and automotives areas.

We are looking forward to setting up business relationship with you and hope to provide you with the best service and solution. Let us make a better world for our industry!



Contact us

Tel: +86-755-8981 8866 Fax: +86-755-8427 6832

Email & Skype: info@chipsmall.com Web: www.chipsmall.com

Address: A1208, Overseas Decoration Building, #122 Zhenhua RD., Futian, Shenzhen, China



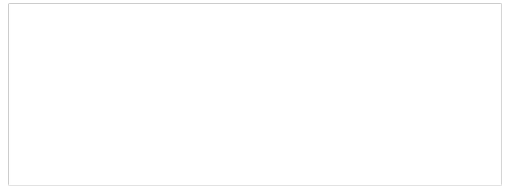
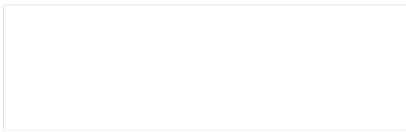

SPECIFICATION



UMSH-8596MD-20T

Date: May 2012

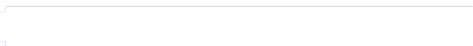

For information on touch sensors, sensor driving and touch panel bonding solutions, scan the QR code or click the URL



SPECIFICATION

OF

LIQUID CRYSTAL DISPLAY MODULE



CUSTOMER : URT-STD

Model No. : UMSH-8596MD-20T

Model version : 0

Document Revision : 2

Preliminary

CUSTOMER APPROVED SIGNATURE			

This specification need to be signed by purchaser or customer as a specification of products production and delivery from URT. Without signature of this specification , any purchase order for this model no. will be treated and considered that this specification is automatically acknowledged and accepted by purchaser or customer.

U.R.T. UNITED RADIANT TECHNOLOGY CORPORATION

Allen Wang
APPROVED

George Tseng
CHECKED

Angus Chiu
CHECKED

Sharon Tsai
PREPARED

May-03-2012
Date

COMPANY : No. 2,Fu-hsing Road,Taichung Economic Processing Zone,Tantzu,Taichung,Taiwan,R.O.C.

TEL: 886-4-25314277

FAX: 886-4-25313067



Revision 2 ; UMSH-8596MD-20T Ver. 0 ; May-03-2012

Page: 1

This document has been signed by Digital Signature Approval System

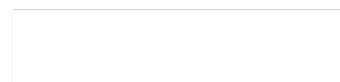

Revision record

Document Revision	Model No. Version No.	Description	Revision by
0	UMSH-8596MD-T (UFSH-K106EY-FT) Version No. 0	7.0" TFT.(backlight luminance 300cd/m ²)	Y.D. Shie Zi Xin Ou 25-May-2011
1	UMSH-8596MD-1T (UFSH-K106EY-FT) Version No. 0	Modify the backlight luminance from 300cd/m ² to 500cd/m ² .	Y.D. Shie Zi Xin Ou 10-Jun-2011
2	UMSH-8596MD-20T (UFSH-K106EY-FT) Version No. 0	1. Add the capacitive touch panel. (Two Finger multi Touch , two Fingers detection) 2. Modify the module number from UMSH-8596MD-1T to UMSH-8596MD-20T.	Y.D. Shie Zi Xin Ou 03-May-2012
		Revision 2 ; UMSH-8596MD-20T Ver. 0 ; May-03-2012	Page: 2

CONTENTS:

No.	Item	Page
1	BASIC SPECIFICATION 1.1 Mechanical Specification 1.2 Display Specification 1.3 Outline Dimension 1.4 Block Diagram 1.5 Interface Pin	4 4 5 6 7
2	ELECTRICAL CHARACTERISTICS 2.1 Absolute Maximum Ratings 2.2 DC Characteristics 2.3 Back-light 2.4 AC Characteristics 2.5 Capacitive touch panel controller AC Characteristics 2.6 I2C Host Interface Protocol	8 9 10 11~12 13 14~16
3	OPTICAL CHARACTERISTICS 3.1 Condition 3.2 Definition of Optical Characteristics	17 18~19
4	RELIABILITY	20
5	PRODUCT HANDING AND APPLICATION	21
6	DATECODE	22
7	PACKING & LOTNO	23~24
8	INSPECTION STANDARD	25~28

1. BASIC SPECIFICATION

1.1 Mechanical specifications

Items	Nominal Dimension	Unit
Active screen size	7.0" Diagonal	-
Dot Matrix	800 x RGB x 480	dots
Module Size (W x H x T)	165.0 x 106.4 x 8.2	mm.
Active Area (W x H)	152.4 x 91.44	mm.
Pixel Size (W×H)	0.1905 x 0.1905	mm.
Color depth	262K	color
Interface	Parallel 18-bit RGB	-
Driving IC Package	COG	-
Module weight	193	g

1.2 Display specification

Display	Descriptions	Note
LCD Type	a-Si TFT	
LCD Mode	TN / Normal white	
Polarizer Mode	Transmissive	
Polarizer Surface	Normal	
Pixel arrangement	RGB-stripe	
Backlight Type	LED	
Viewing Direction(Gray inversion)	6 O'clock Direction	1

*Color tone is slightly changed by temperature and driving voltage.

Note 1 : The viewing direction defined in this specification follows the rubbing direction of its mother TFT surface treatment.

The grayscale inversion is at this direction as well. The optimized viewing direction applied into end-device is decided by customers.

1.3 Outline dimension

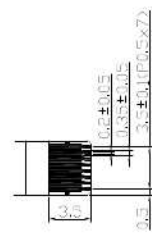
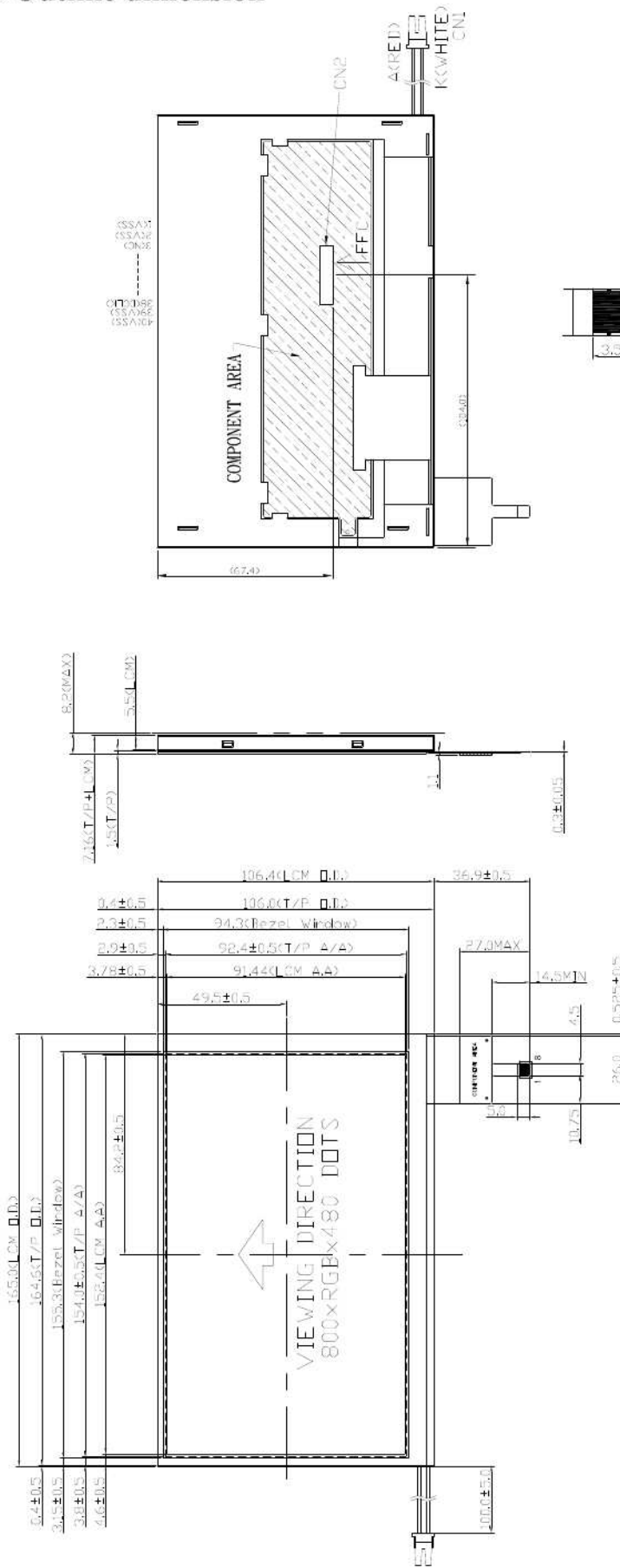

DETAIL A

Touch panel	Pin No.	Pin Name
1	VDD	
2	GND	
3	GND	
4	RST	
5	INT	
6	SCL	
7	GND	
8	SDA	

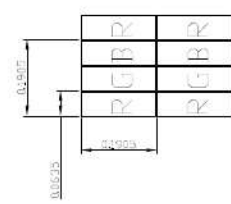

DOTS DETAIL

- TFT LCM NOTE :
1. LCD : TFT TRANSMISSIVE TYPE , NORMAL WHITE
 2. VIEWING DIRECTION : 6 O'CLOCK
 3. Top : -20~70°C , Tst : -30~80°C
 4. LED COLOR : WHITE , 21 PCS DICE
CONSTANT CURRENT : 210mA ; Vled=9.9V(TYP)
 5. LCM MODULE BRIGHTNESS : 400 cd/m² (TYP)
 6. GENERAL TOLERANCE:±0.3
 7. CN1:BHSR-02VS-1(JUST)
 8. CN2:9681-(IROS0)
 9. PROJECTIVE CAPACITIVE TYPE TOUCH PANNEL
 10. THE MINIMUM BENDABLE RADIUS(INNER) OF THE FPC IS 1.0 mm
 11. TWO POINT TOUCH; INTERFACE: I2C

1.4 Block diagram:

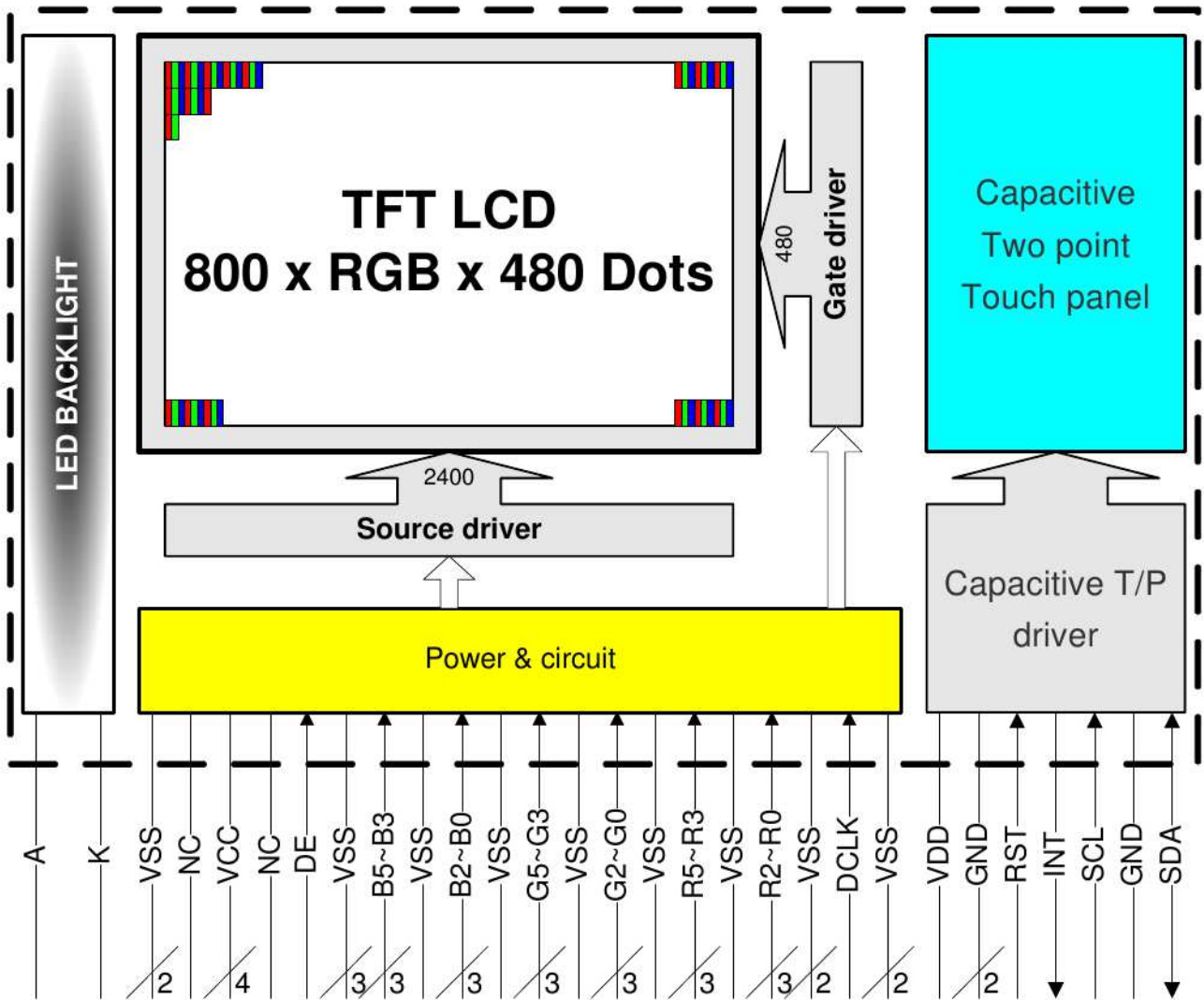

1.5 Interface pin

Pin No.	Pin Symbol	I/O	Description
1~2	VSS	P	GND
3	NC	-	No connection
4~7	VCC	P	Power supply for Module (+3.3V)
8	NC	-	No connection
9	DE	I	Data enable
10~12	VSS	P	GND
13~15	B5~B3	I	Blue data input
16	VSS	P	GND
17~19	B2~B0	I	Blue data input
20	VSS	P	GND
21~23	G5~G3	I	Green data input
24	VSS	P	GND
25~27	G2~G0	I	Green data input
28	VSS	P	GND
29~31	R5~R3	I	Red data input
32	VSS	P	GND
33~35	R2~R0	I	Red data input
36~37	VSS	P	GND
38	DCLK	I	Dot clock
39~40	VSS	P	GND

B/L interface pin :

Pin No.	Pin Symbol	I/O	Description
1	A	P	Power supply for LED+
2	K	P	Power supply for LED-

Capacitive touch panel (I2C) Interface:

Pin No.	Pin Symbol	I/O	Description
1	VDD	P	Power supply (+3.3V)
2~3	GND	P	Ground.
4	RST	I	System reset signal input, active low. Note (1)
5	INT	O	Active low when data output from touch panel.
6	SCL	I	Serial Clock.
7	GND	P	Ground.
8	SDA	I/O	Serial data access.

Note (1): Reset pin is low active and needs hold low for 1ms to take effect.

2. ELECTRICAL CHARACTERISTICS

2.1 Absolute Maximum Ratings

Items	Symbol	Min.	Max.	Unit
Power supply voltage	VCC	-0.3	7.0	V
	VDD	2.4	3.6	V
Input voltage	V _{in}	-0.3	VCC+0.3	V
Operate temperature range	T _{OP}	-20	70	°C
Storage temperature range	T _{ST}	-30	80	°C

2.2 DC Characteristics

$T_a = 25^\circ\text{C}$

Items	Symbol	Min.	Typ.	Max.	Unit	Condition
Supply voltage	VCC	-	3.3	-	V	-
	VDD	-	3.3	-	V	-
Input Voltage	V _{IL}	0	-	0.3VCC	V	L level
	V _{IH}	0.7VCC	-	VCC	V	H level
Current consumption	I _{VCC}	-	160	250	<u>mA</u>	Note 1
	I _{VDD}	-	6	12	<u>mA</u>	-

*Note1 :

Measuring Condition:

Standard Value MAX.

$T_a = 25^\circ\text{C}$

VCC -GND = 3.3V

Display Pattern = Check pattern



0 gray black pattern

2.3 Back-light Characteristics

PARAMETER	SYMBOL	MIN	TYP	MAX	Unit	Test Condition	NOTE
Supply Current	If	-	210	-	mA	Ta=25°C	-
Supply Voltage	Vf	-	9.9	-	V	Ta=25°C	-
Half-Life Time	Lf	-	50000	-	hrs	Ta=25°C	1

Note 1 : The " Half-Life Time" is defined as the LED chip brightness decreases to 50% than original brightness, Based on Ta 25±2°C, 60±10% RH condition .

Note 2 : LED backlight is 21 LEDs.

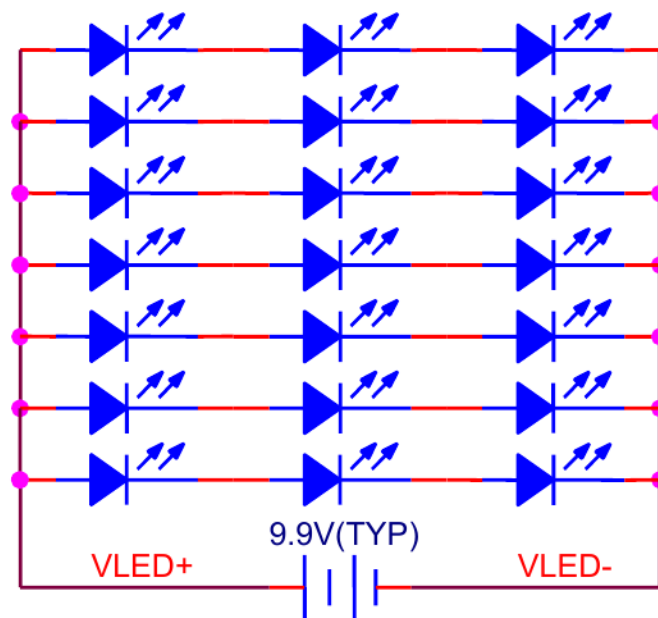

2.4 AC Characteristics

Switching characteristics

PARAMETER	Symbol	Spec.			Unit
		Min.	Typ.	Max.	
Data setup time	T_{dsu}	6	-	-	ns
Data hold time	T_{dhd}	6	-	-	ns
DE setup time	T_{esu}	6	-	-	ns
Source output settling time	T_{ST}	-	-	15	μ s
Source output loading R	R_{SL}	-	2	-	K ohm
Source output loading C	C_{SL}	-	60	-	pF

Parallel RGB Input Timing Requirement

DE mode

PARAMETER	Symbol	Spec.			Unit
		Min.	Typ.	Max.	
CLK frequency	F_{CPH}	-	33.26	-	MHz
CLK period	T_{CPH}	-	30.06	-	ns
CLK pulse duty	T_{CWH}	40	50	60	%
DE period	$T_{DEH}+T_{DEL}$	1000	1056	1200	T_{CPH}
DE pulse width	T_{DEH}	-	800	-	T_{CPH}
DE frame blanking	T_{DEB}	10	45	110	$T_{DEH}+T_{DEL}$
DE frame width	T_{DE}	-	480	-	$T_{DEH}+T_{DEL}$

PARAMETER	Symbol	Spec.			Unit
		Min.	Typ.	Max.	
OEV pulse width	T_{OEV}	-	150	-	T_{CPH}
CKV pulse width	T_{CKV}	-	133	-	T_{CPH}
DE(internal)-STV time	T_1	-	4	-	T_{CPH}
DE(internal)-CKV time	T_2	-	40	-	T_{CPH}
DE(internal)-OEV time	T_3	-	23	-	T_{CPH}
DE(internal)-POL time	T_4	-	157	-	T_{CPH}
STV pulse width	-	-	1	-	T_H

(i). $T_{HS}+T_{HA}<T_H$

Timing Controller Timing Chart

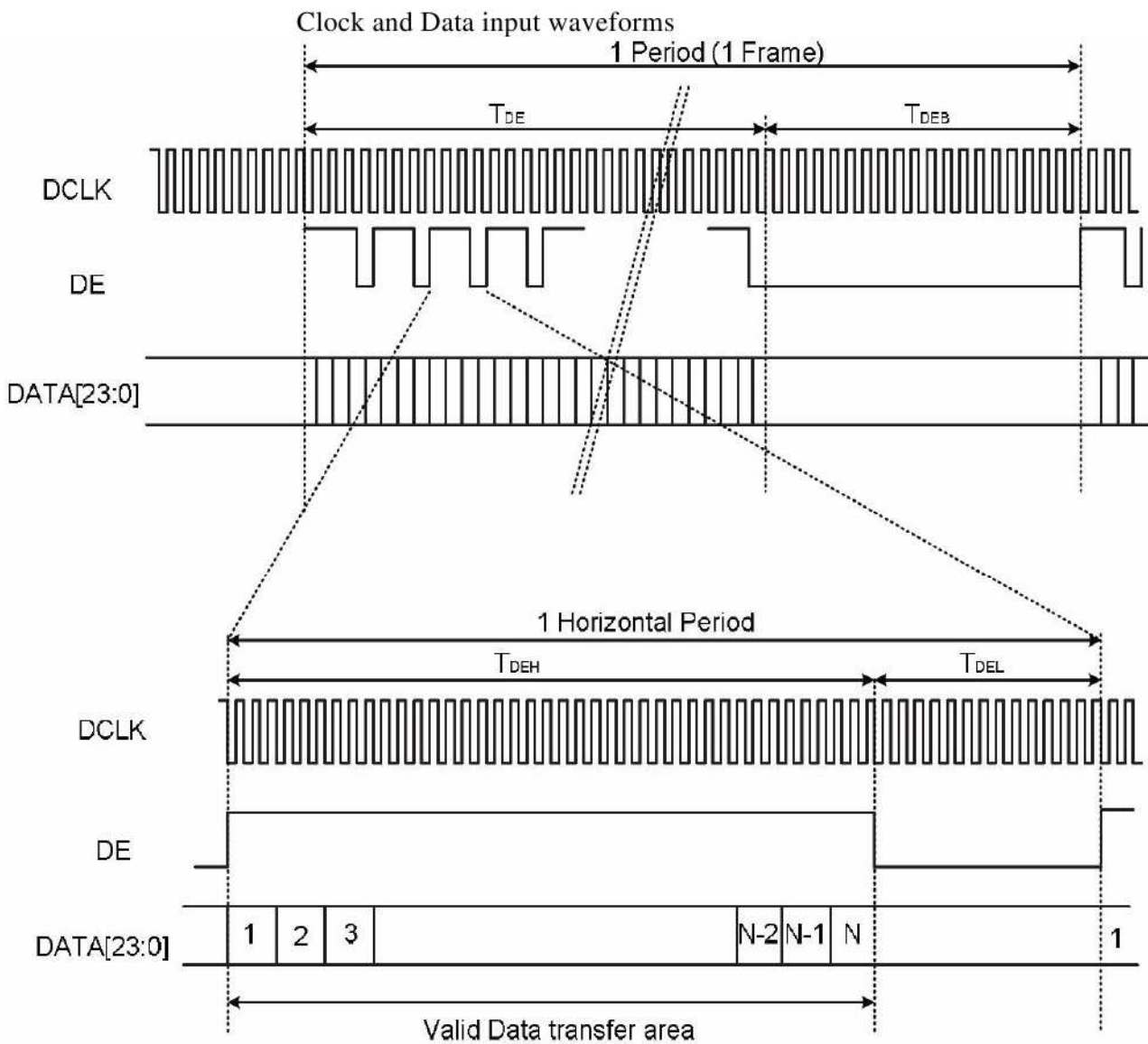
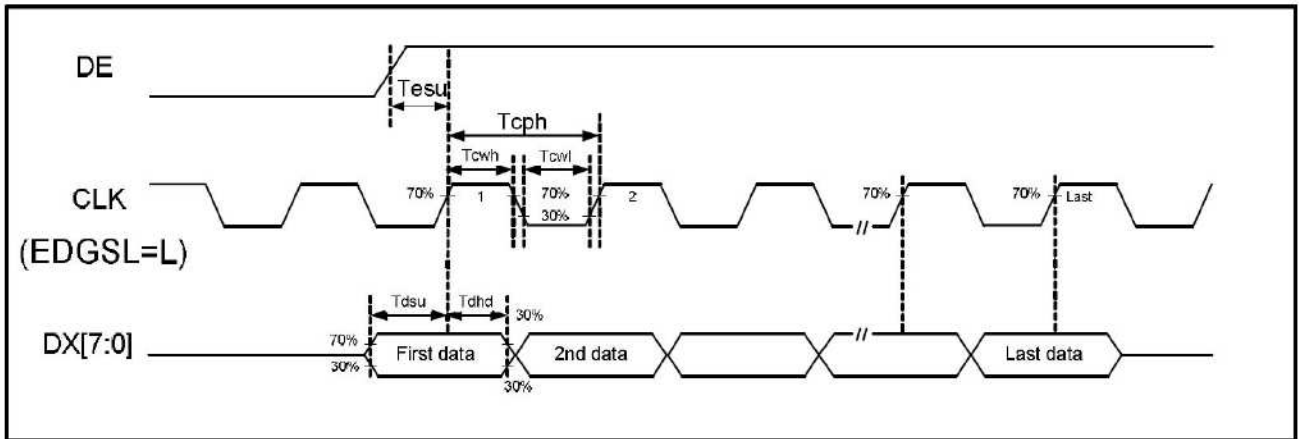

DE Mode Data Format

2.5 Capacitive touch panel controller AC Characteristics

AC Electrical Characteristics

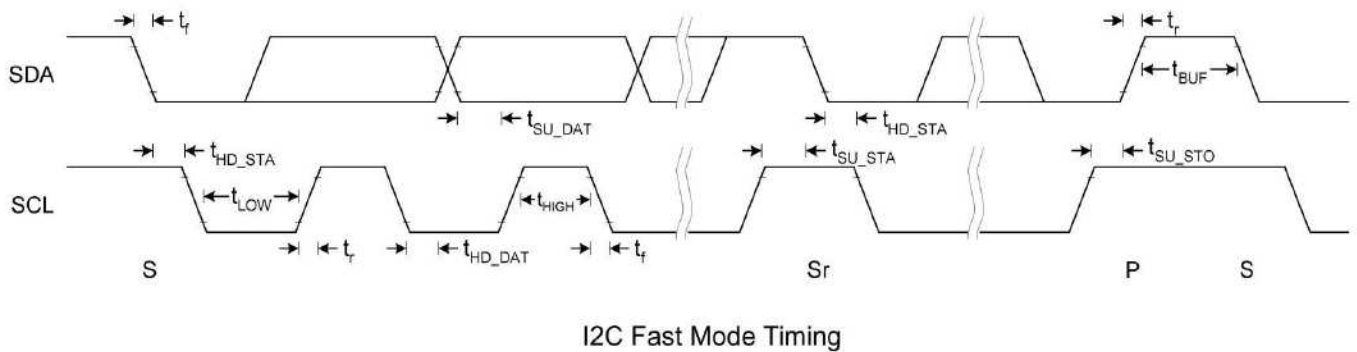

I2C Fast Mode Timing Characteristic

Conditions: VDD = IOVDD = 3.3V, GND = 0V, T_A = 25°C

Symbol	Parameter	Rating			Unit
		Min.	Typ.	Max.	
f _{SCL}	SCL clock frequency	0	-	400	kHz
t _{LOW}	Low period of the SCL clock	1.3	-	-	us
t _{HIGH}	High period of the SCL clock	0.6	-	-	us
t _f	Signal falling time	-	-	300	ns
t _r	Signal rising time	-	-	300	ns
t _{SU_STA}	Set up time for a repeated START condition	0.6	-	-	us
t _{HD_STA}	Hold time (repeated) START condition. After this period, the first clock pulse is generated	0.6	-	-	us
t _{SU_DAT}	Data set up time	100	-	-	ns
t _{HD_DAT}	Data hold time	0	-	0.9	us
t _{SU_STO}	Set up time for STOP condition	0.6	-	-	us
t _{BUF}	Bus free time between a STOP and START condition	1.3	-	-	us
C _b	Capacitive load for each bus line	-	-	400	pF

2.6 I2C Host Interface Protocol

I2C Slave Interface

Read

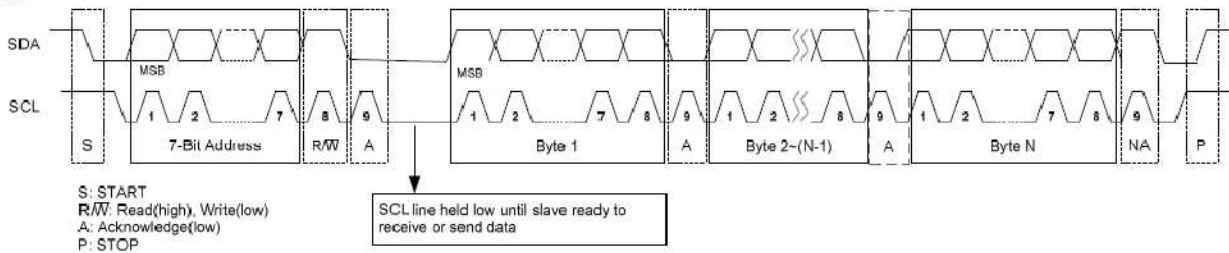

Write

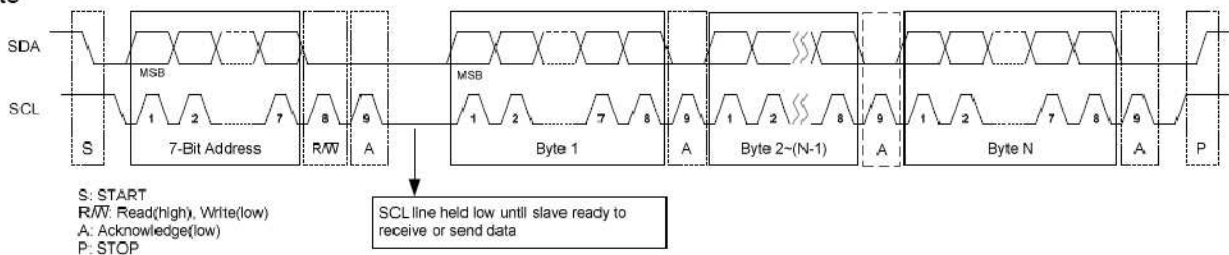

2.6.1 Register Read

For reading register value from I2C device, host has to tell I2C device the *Start Register Address* before reading corresponding register value.

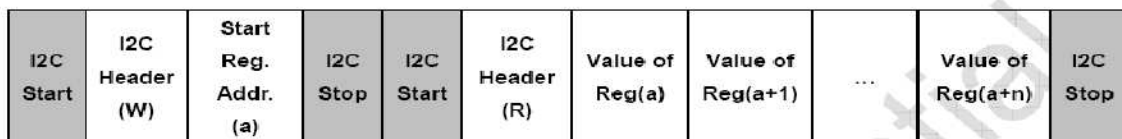

Figure 1. Register Read Format.

ST1232/ST1332 I2C host interface protocol supports *Repeated Register Read*. That is, once the *Start Register Address* has been set by host, consequent I2C Read(R) transactions will directly read register values starting from the *Start Register Address* without setting address first, as shown in Figure 2.



Figure 2. Repeated Register Read.

Header Value : 0xab

2.6.2 Register Write

For writing register to I2C device, host has to tell I2C device the *Start Register Address* in each I2C Register Write transaction. Register values to the I2C device will be written to the address starting from the *Start Register Address* described in Register Write I2C transaction as shown in Figure 3.

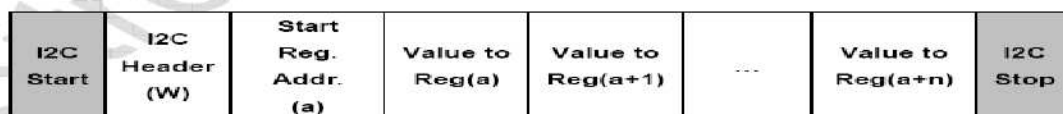

Figure 3. Register Write Format.

Header Value : 0xaa

2.6.3 Registers

ST1332 provides a register set for host to configure device attributes and retrieve information about fingers,

Host Interface Registers (Report Page)									
Reg Addr.	Name	Bit 7	Bit 6	Bit 5	Bit 4	Bit 3	Bit 2	Bit 1	Bit 0
0x00	----	Reserved							
0x01	----	Reserved							
0x02	Device Control Reg	Reserved				Reserved	Reserved	Power Down (R/W)	Reset (R/W)
0x03	Timeout to Idle Register	Timeout to Idle (Sec) (R/W)							
0x04 ~ 0x0F	-----	Reserved							
0x10	Fingers	Reserved				Fingers(RO)			
0x11	-----	Reserved							
0x12	XY0 Coord (High Byte)	Valid 0 (RO)	X0_H(RO)			Reserved	Y0_H (RO)		
0x13	X0 Coord (Low Byte)	X0_L(RO)							
0x14	Y0 Coord (Low Byte)	Y0_L(RO)							
0x15	XY1 Coord (High Byte)	Valid 1 (RO)	X1_H(RO)			Reserved	Y1_H (RO)		
0x16	X1 Coord (Low Byte)	X1_L(RO)							
0x17	Y1 Coord (Low Byte)	Y1_L(RO)							

2.6.4 Device Control Register

Reg Addr.	Name	Bit 7	Bit 6	Bit 5	Bit 4	Bit 3	Bit 2	Bit 1	Bit 0
0x02	Device Control Reg	Reserved				Reserved	Reserved	Power Down (R/W)	Reset (R/W)

Device Control Register provides device control bits for host to reset the device , power down the device.

2.6.5 Timeout to Idle Register

Reg Addr.	Name	Bit 7	Bit 6	Bit 5	Bit 4	Bit 3	Bit 2	Bit 1	Bit 0
0x03	Timeout to Idle Register	Timeout to Idle (Sec) (R/W)							

Timeout to Idle Register provides timeout control to entering Idle Mode for host.

The touch controller will enter Idle Mode after the number of seconds specified in Timeout to Idle Register if there is no touch detected in this period.

Set the field to 0xFF will disable Idle Mode. Set the field to 0 will entering Mode immediately.

The default value of Timeout to Idle Register is set to 0x08 for 8 seconds to Idle Mode.

2.6.6 Fingers Register

Reg Addr.	Name	Bit 7	Bit 6	Bit 5	Bit 4	Bit 3	Bit 2	Bit 1	Bit 0	
0x10	Fingers	Reserved				Fingers(RO)				

Fingers field represents number of fingers detected by touch controller.

The coordinates of each finger detected are represents in X Coordinate and Y Coordinate fields.

2.6.7 XY Coordinate Registers

Reg Addr.	Name	Bit 7	Bit 6	Bit 5	Bit 4	Bit 3	Bit 2	Bit 1	Bit 0
0x12	XY0 Coord (High Byte)	Valid 0 (RO)	X0_H(RO)			Reserved	Y0_H (RO)		
0x13	X0 Coord (Low Byte)	X0_L(RO)							
0x14	Y0 Coord (Low Byte)	Y0_L(RO)							
0x15	XY1 Coord (High Byte)	Valid 1 (RO)	X1_H(RO)			Reserved	Y1_H (RO)		
0x16	X1 Coord (Low Byte)	X1_L(RO)							
0x17	Y1 Coord (Low Byte)	Y1_L(RO)							

XY Coordinate Registers represent the XY coordinates for each touch point ID.

Valid bit field tells that this point ID is valid and the XY information represents a real touch point on touch sensor.

3. OPTICAL CHARACTERISTICS

3.1 Characteristics

Electrical and Optical Characteristics

No.	Item	symbol / temp.	Min.	Typ.	Max.	Unit	Note		
1	Response Time	Tr	25 ϕ J	NA	5	10	ms	2	
		Tf	25 ϕ J	NA	15	20			
2	Viewing Angle	Hor.	$\angle K_{2+}$	Center CR \geq 10	60	85	-	degree	3
			$\angle K_{2-}$		60	85	-		
		Ver.	$\angle K_{1+}$		60	85	-		
			$\angle K_{1-}$		60	85	-		
3	Contrast Ratio	Cr	25 ϕ J	700	1000	-	-	4	
	Red x-code	Rx	25 ϕ J	-	0.58	-	-	5	
	Red y-code	Ry		-	0.35	-			
	Green x-code	Gx		-	0.35	-			
	Green y-code	Gy		-	0.57	-			
	Blue x-code	Bx		0.10	0.15	0.20			
	Blue y-code	By		0.08	0.13	0.18			
	White x-code	Wx		0.26	0.31	0.36			
	White y-code	Wy		-	0.34	-			
	Brightness	Y		300	400	-			cd/m ²
5	Brightness Uniformity		25 ϕ J	80	-	-	%	6	

3.2 Definition of optical characteristics

Measurement condition :

Transmissive and Transflective type

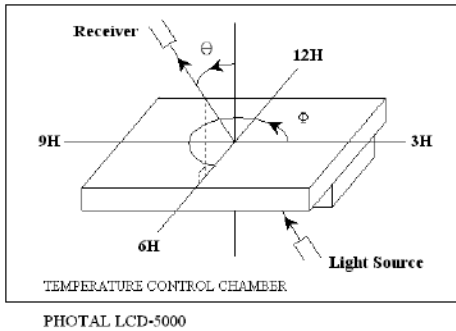

[Note 1] Definition of LCD Driving Vop and Waveform :

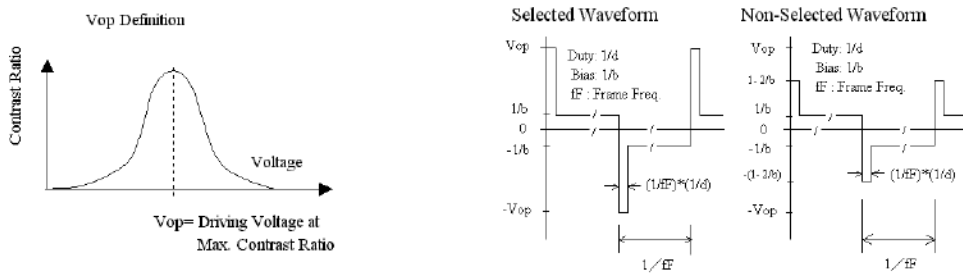

[Note 2] Definition of Response Time

for Positive type :

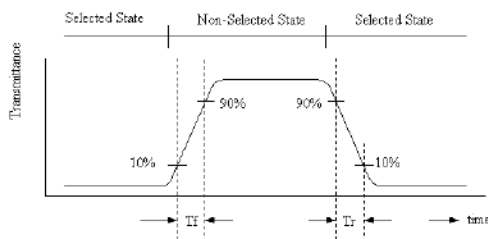

[Note 3] Definition of Viewing Angle :

[Note 4] Definition of Contrast Ratio :

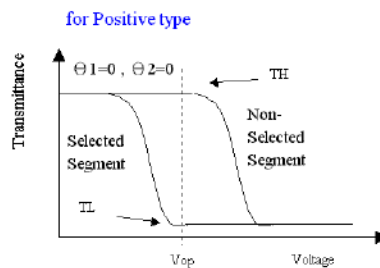

$$\text{Contrast Ratio} = \frac{TH}{TL}$$

[Note 5] Definition of measurement of Color Chromaticity and Brightness

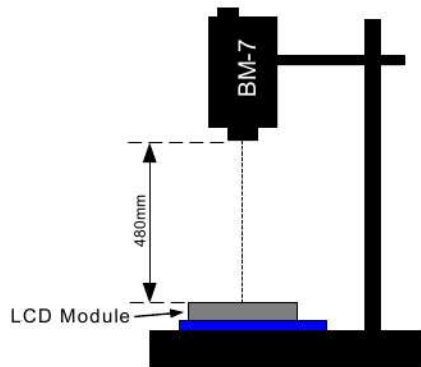

[Note 6] Definition of Brightness Uniformity

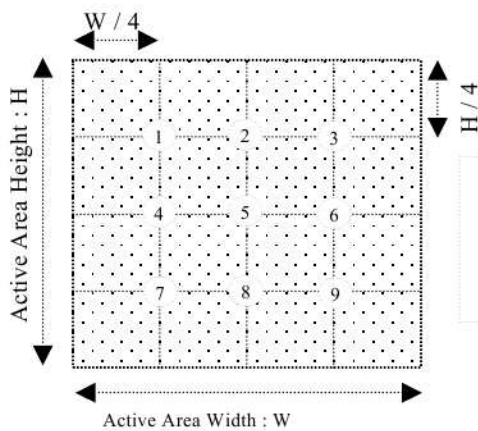

$$\text{Brightness Uniformity} = \frac{\text{Minimum Brightness of Point 1~9}}{\text{Maximum Brightness of Point 1~9}}$$

[Note 7] Definition of Measurement of Reflectance

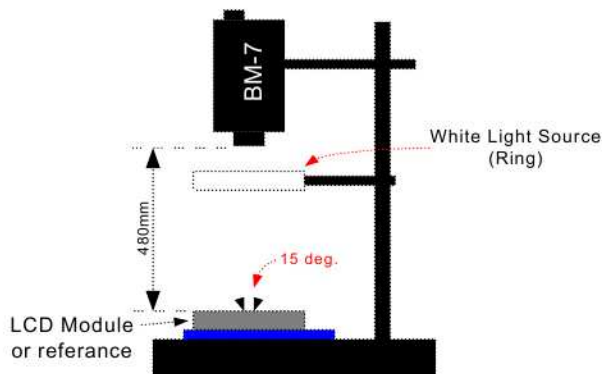

4. RELIABILITY :

Item No	Items	Condition
1	High temperature operating	70 °C , 200 hours
2	Low temperature operating	-20 °C , 200 hours
3	High temperature storage	80 °C , 200 hours
4	Low temperature storage	-30 °C , 200 hours
5	High temperature & humidity storage	60°C, 90%RH, 100 hours
6	Thermal Shock storage	-30°C, 30min.<=> 80°C, 30min. 10 Cycles
7	Vibration test	10 => 55 =>10 => 55 => 10 Hz , within 1 minute Amplitude : 1.5mm. 15 minutes for each Direction (X,Y,Z)
8	Drop test	Packed, 100CM free fall, 6 sides, 1 corner, 3edges
9	Life time	50,000 hours 25°C , 60%RH , specification condition driving

- * One single product test for only one item.
- * Judgment after test : keep in room temperature for more than 2 hours.
 - Current consumption < 2 times of initial value
 - Contrast > 1/2 initial value
 - Function : work normally

5. PRODUCT HANDLING AND APPLICATION

¼ PRECAUTION FOR HANDLING LCM

- i' The LCD module contains a C-MOS LSI. People who operate the LCM should wear ESD protection equipment to prevent ESD hurt on products.
- i' Do not input any signal before power is turned on.
- i' Do not take LCM from its packaging bag until it is assembled.
- i' Peel off the LCM protective film slowly since static electricity may be generated.
- i' Pay attention to the humidity of the work shop, 50~60%RH is satisfactory.
- i' Use a non-leak iron for soldering LCM.
- i' Do not touch the display surface or connection terminals area with bare hands. Smudges on the display surface reduce the insulation between terminals.
- i' Cautions for soldering to LCM:
 - Condition for soldering I/O terminals:
 - Temperature at iron tip : $350\text{°C} \pm 15\text{°C}$.
 - Soldering time : 3~4sec./ terminals.
 - Type of solder : Eutectic solder (rosin flux filled).

¼ PRECAUTION IN USE OF LCM

- i' Do not contact or scratch the front surface and the contact pads of a LCM with hard materials such as metal or glass or with one's nail.
- i' To clean the surface, wipe it gently with soft cloth dampened by alcohol.
- i' Do not attempt to wipe off the contact pads.
- i' Keep LCM panels away from direct sunlight, also avoid them in high-temperature & high humidity environment for a long period.
- i' Do not drive LCM by DC voltage.
- i' Do not expose LCM to organic solvent.
- i' Liquid in LCM is hazardous substance. In case a contact with liquid crystal material is occurred, be sure to immediately wash such material away by soap and water.
- i' The polarizer is easily damaged and should be handled with special care. Don't press or rub it with hard objects.

¼ PRECAUTION FOR STORING AND USE OF LCM

- i' To avoid degradation of the device, do not store the module under the conditions of direct sunlight, high temperature or high humidity. Keep the module in bags designed to prevent static electricity charging under low temperature / normal humidity conditions (avoid high temperature / high humidity and low temperature below 0°C)
- i' Never use the LCD, LCM under 45 Hz, the liquid crystal will decompose and cause permanent damage on display !!

¼ USING ON MEDICAL CARE, SAFETY OR HAZARDOUS APPLICATION OR SYSTEM

- i' For the application in medical care, safety and hazardous products or systems, an authorization from URT is required. URT will not be responsible for any damage or loss which is caused by the products without any authorization given by URT.
- i' This product is not allowed to be designed and used for military application and/or purpose.
- i' The delivery of this product to the countries and/or regions where the embargoes are imposed by U.N. is prohibited.
- i' The application and delivery of this product must comply with Strategic High-Tech Commodities (SHTC) export control and the sales to the embargoed and/or sanctioned countries or regions are strictly prohibited.

6. DATE CODE OF PRODUCTS

i' Date code will be shown on each product :

i' YY MM DD - XXXX
| | | |
Year Month Day - Production lots

i' Example: 090508 - 0 0 0 3 ==>Year 2009, May.,08rd , Batch no.03

7. PACKING

Instruction of lot number:

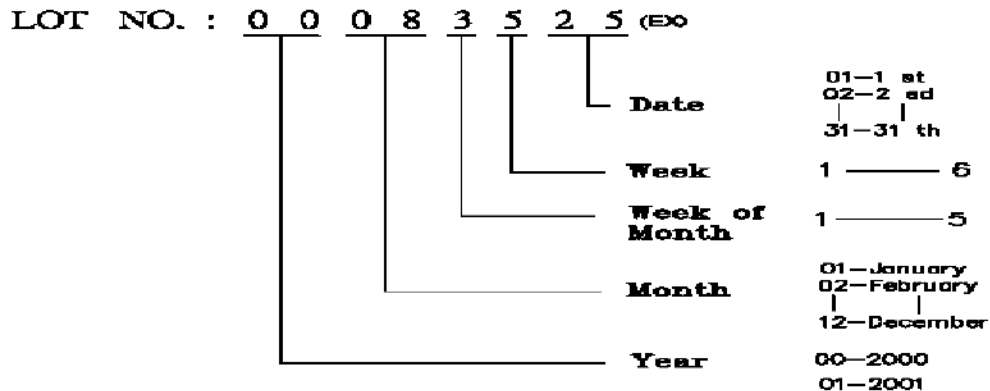

Label of carton:

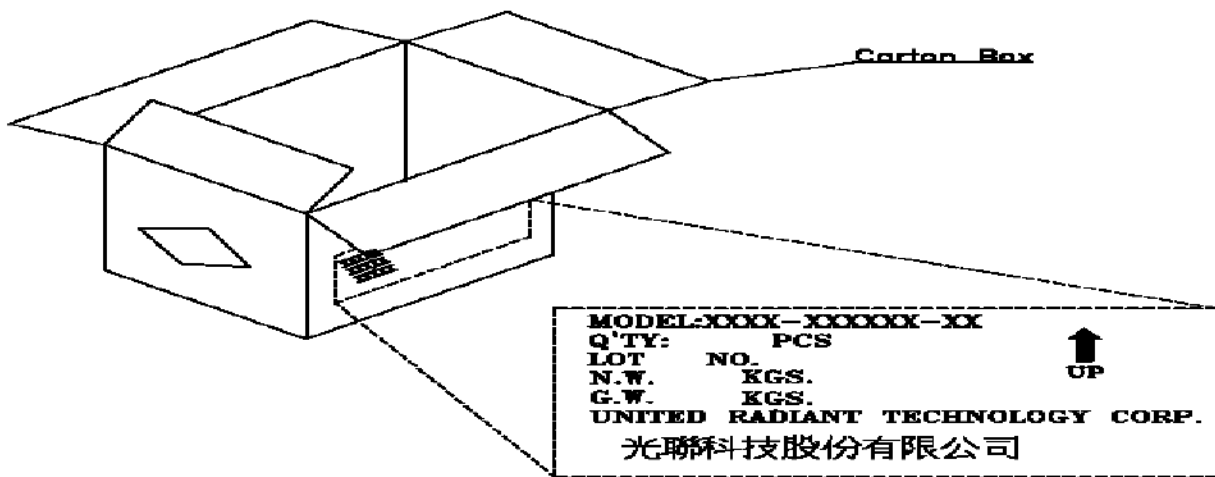

Packing tray must be stacked with alternated direction to each others.
 To tacks packing trays in same direction will cause product damaged.

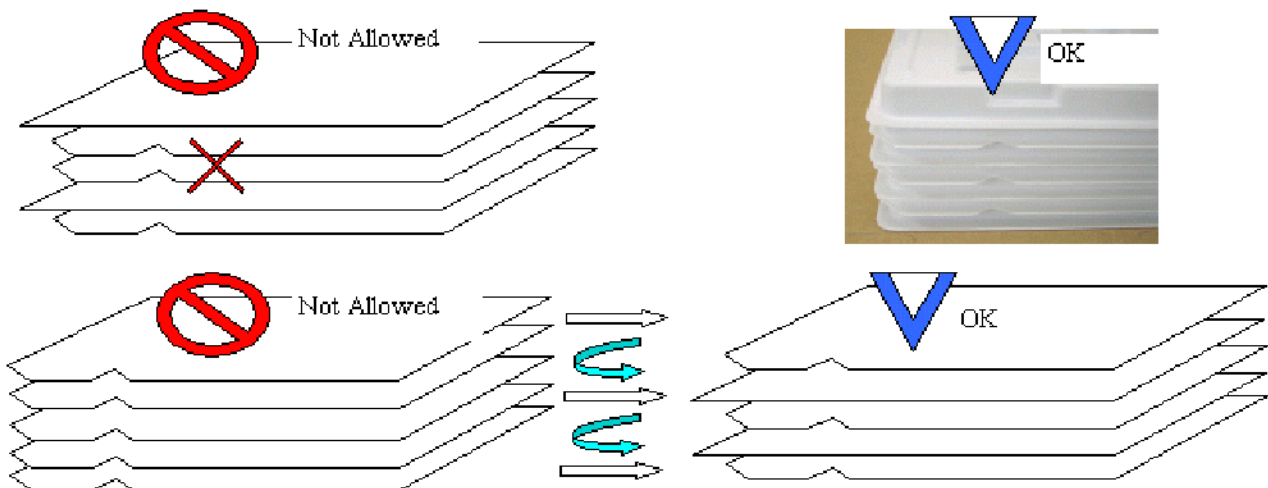

MODEL NO: UM*

T.B.D pcs / Tray

T.B.D Tray / Box

T.B.D Box / Carton

T.B.D pcs / Carton

NOTE:

- (1) Be warned, the direction of the tray has to turn it by 180 degree before stack it up. Otherwise, it will be packager's responsibility!!
- (2) Safe Stack : 5 cartons only

