



Chipsmall Limited consists of a professional team with an average of over 10 year of expertise in the distribution of electronic components. Based in Hongkong, we have already established firm and mutual-benefit business relationships with customers from,Europe,America and south Asia,supplying obsolete and hard-to-find components to meet their specific needs.

With the principle of “Quality Parts,Customers Priority,Honest Operation,and Considerate Service”,our business mainly focus on the distribution of electronic components. Line cards we deal with include Microchip,ALPS,ROHM,Xilinx,Pulse,ON,Everlight and Freescale. Main products comprise IC,Modules,Potentiometer,IC Socket,Relay,Connector.Our parts cover such applications as commercial,industrial, and automotives areas.

We are looking forward to setting up business relationship with you and hope to provide you with the best service and solution. Let us make a better world for our industry!



Contact us

Tel: +86-755-8981 8866 Fax: +86-755-8427 6832

Email & Skype: info@chipsmall.com Web: www.chipsmall.com

Address: A1208, Overseas Decoration Building, #122 Zhenhua RD., Futian, Shenzhen, China



UFE / UFR Series

Up to 6000 Watts

Total Power: Up to 6000 W
Input Voltage: 85 - 264 Vac
of Outputs: Single + Aux
Output: 24 V & 48 V



Special Features

- Rack mounted chassis (1U, 19")
- 3 hot pluggable rectifiers per 1U chassis, up to 4 kW redundant or 6 kW available power (180 - 264 Vac input)
- Up to 2.6 kW redundant or 3.9 kW available per shelf at 90 - 132 Vac input
- Stackable to 6U high to provide up to 36 kW available power
- Class B conducted EMI EN55022 (See Note 1)
- Automatic fan speed control with fault reporting
- Auxiliary standby output, 11 V at approximately 2.8 W
- High density up to 22 W/in³
- High efficiency up to 91%
- Floating as well as isolated main output voltage allows positive or negative polarity operation
- EU directive 2002/95/EC compliant for RoHS
- 2 year warranty
- PMBus compliant

Safety

- VDE EN/IEC60950-1
- UL/cUL60950-1

Electrical Specifications

Output		
Output Power:	Main output Auxiliary output	See Table 1 11 V ±15%, 2.875 W
Line regulation:	Low line to high line	±0.15% max.
Load regulation (active share mode):	Full load to min. load	±0.15% max.
Turn-on delay:	(See Note 4)	5.0 s max.
Ambient temp. coefficient:	At full load, min. Vin	± 0.005%/°C
Voltage adjustability: Adjustable PMBus command (See Note 6)	48 Vout 24 Vout	42-57 Vdc 21-28.5 Vdc
Output setpoint accuracy:		± 0.5%
Default output voltage: setting 25 °C	48 Vout (active default) 24 Vout (active default)	48 V ± 0.5% @ 41 A 27 V ± 0.5% @ 48 A
Voltage droop: (operation set PMBus command)	24 Vout 48 Vout	40.3 mV/A ± 3.0% from 10 A up to power limit 80.6 mV/A ± 3.0% from 10 A up to power limit
Total error band:	-40 °C to +70 °C, FL range	±1.0% max.
Overshoot/undershoot:	Main output @ turn-on/off	0%/0%
Ripple and noise (20 MHz):	Main output, -5 °C and above Auxiliary output	500 mV pk-pk, 150 mV rms 400 mV pk-pk, 150 mV rms
Dynamic regulation (except droop mode):	Peak dev., 25% load step Recovery time	2.5% max. 1 ms max.
Current sharing (See Note 3):	(I1-I2) / ILIMIT x 100	15% max.

All specifications are typical at nominal input, full load at 25 °C ambient unless otherwise stated.



Input		
Input voltage range: (See note 2)		88 - 264 Vac 176 - 264 Vac
Input frequency range:		47 - 63 Hz
Input current:		15 A max.
Ground leakage current:	AC to safety ground	2 mA max.
Input fuse (internal)	Both lines fused	30 A
Power factor:	50 to 100% load	0.98
Undervoltage lockout: (power up)	High line range	176 Vac max.
	Wide line range	88 Vac. max
Undervoltage lockout: (power down)	High line range	162 Vac min. LED warning @ 176 V max.
	Wide line range	76 Vac min. LED warning @ 88 V max.

Notes

- Final EMI performance is system/shelf dependent.
- Auto ranging sets power limit based on input voltage at turn on.
- The difference in output current among any two rectifiers operating in parallel does not exceed a value equal to 15% of the rated current limit. This specification applies for operation with any output current from no load to 110% of maximum.
- Maximum 15 minute warm up time at light loads below -15 °C. See Application Note 212 for cold start timing data.
- For operation above 1,524 m (5,000 ft), maximum operation temperature is derated by 2 °C per 305 m (1,000 ft).
- Output voltage can be modified on the fly between 21-28.5 V (24 V model) or 42-57 V (48 V model) PMBus command.
- PM BUs communication. Pin names in parenthesis refer to the PMBus version names. UFE2000-96S48PJ and UFE130096S24PJ use PMBus.

General Specifications		
Electrical insulation:	Input/output	3000 Vac / 4242 Vdc
	Input/chassis	1500 Vac / 2121 Vdc
Switching frequency:	Fixed	450 kHz
Approvals and standards:		VDE EN/IEC60950-1 UL/CUL60950-1
Weight:		5.5 lbs
Hold-up time:	48 Vout at rated output power	20 ms min.
	24 Vout at rated output power	20 ms min.
MTBF (@25 °C):	Telcordia SR-332 Issue 1	279,069 hours
Acoustical noise:	Over all conditions	71 dB max.
	25 °C ambient at rated output power	58 dB typ.

EMC		
Conducted emissions:	EN55022, FCC part 15	Class B (when installed in system)
Immunity:		
Harmonic current:	EN61000-3-2	Compliant
ESD air/contact:	EN61000-4-2	Level 3
Surge:	EN61000-4-5	
Fast transients:	EN61000-4-4	Level 3
Flicker:	EN61000-3-3	Compliant
Magnetic field:	EN61000-4-8	Compliant
Radiated immunity:	EN61000-4-3	Level 3
Conducted immunity:	EN61000-4-6	Level 3

Ordering Information

Rated Output Power	Output Voltage Vout		Output Current (Min)	Power Limit +15% / -0% Vout (min)	Line Range at Turn On (Auto Ranging)	Operating Line Range	Current Limit (Vout) < Vout (min)	Model Numbers (7)	Order Number
	Min	Max							
24 Vout Models									
1300 W	21 v	28.5 V	0 A	1300 W	90-264 Vac	65 A	65 A	UFE1300-96S24C1J	UFE1300-5
48 Vout Models									
1300 W	42 V	57 V	0 A	1300 W	90-264 Vac	33 A	33 A	UFE2000-96S48PJ	UFE2000-9
2000 W	42 V	57 V	0 A	2000 W	180-264 Vac	52 A	52 A		
1300 W	42 V	57 V	0 A	1300 W	90-264 Vac	33 A	33 A	UFE2000-96S48PDJ	UFE2000-9-D
2000 W	42 V	57 V	0 A	2000 W	180-264 Vac	52 A	52 A		
1300 W	42 V	57 V	0 A	1300 W	90-264 Vac	33 A	33 A	UFE2000-96S48PHDJ	UFE2000-9-HD
2000 W	42 V	57 V	0 A	2000 W	180-264 Vac	52 A	52 A		

Rack Ordering Information

Rack Model Number	Hot Plug Interface	Number of Power Modules per Pack
UFR6000-00J	Yes	3
UFR6000-01J	Yes	2 + 1 (Split Rack)
UFR6000P	Blank Panel	3

Environmental Specifications

Thermal performance: (See Notes 4 and derating curves)	Operating Non-operating Cold Start	-33 °C to +70 °C -40 °C to +100 °C -40 °C
Relative humidity: non-condensing	Operating Non-operating	Up to 80% Up to 95%
Altitude: (See Note 5)	Operating Non-operating	10,000 feet max. 35,000 feet max.
Vibration:	Operating Non-operating	1.0 G peak 1.5 G peak
Shock:	Operating Non-operating	10 G peak / 11 ms 40 G peak / 11 ms
Protection		
Power limit: Vo > Vout min		± Rated power +15%/-0%
Current limit:	Constant current limiting - brickwall Vo > Vout min	± limit, ± 8%
Short-circuit:	Hiccup mode at Vo < 40 Vdc Vo < 20 Vdc	200 ms on / 1/8 s off
Overvoltage:	Output shutdown Latching after 1 retry	60 V max. 32 V max.
Thermal:	Self protecting	Non-latching
OR-ing fault (See Note 7)	Tested via I ² C or PMBus	LED alarm (by read) in case of OR-ing fault
Communication Monitoring Readout Accuracy		
Current:	Valid from 15% to max. load	± 15%
Voltage:	Measured before output OR-ing	± 5%
Temperature:	Measured Internal output OR-ing	± 5 °C
Hours counter:		± 36 s/hours approx.

Part Number System with Options

Product Family	Rated Output Power	Input Range	Standard Compliance	Type of Output	Output Voltage	Communications Type	Option Code	Special Modification	RoHS Compliance ⁽⁹⁾
UFE	2000	9	6	S	48	P	D	XX	J
UFE = Universal Front-End	1300 = 1300 Watts 2000 = 2000 Watts	9 = Universal Input with PFC	6 = UL/CSA/VDE Class A/B	S = Single	48 = 48 V 24 = 24 V	C1 = I ² C serial communication P = PMBus serial communication	None = Active Ishare D = Droop Ishare HD = PS Enable HI/Droop		J = Pb free (RoHS 6/6 compliant)

Mechanical Drawing

Rev.06.14.11_47
UFE / UFR Series
4 of 6

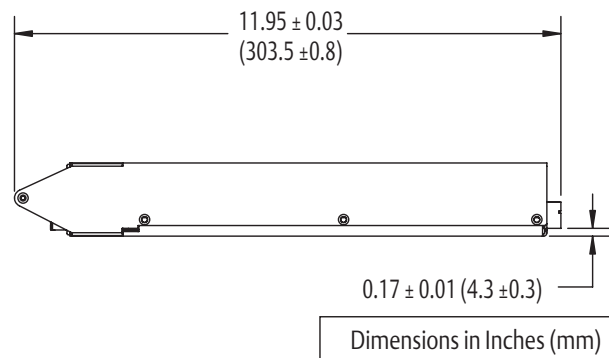
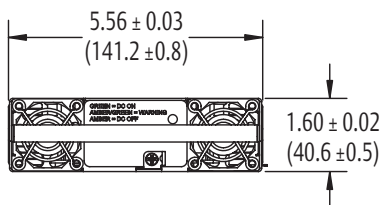
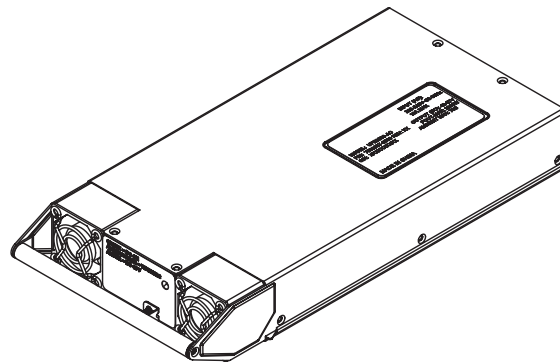
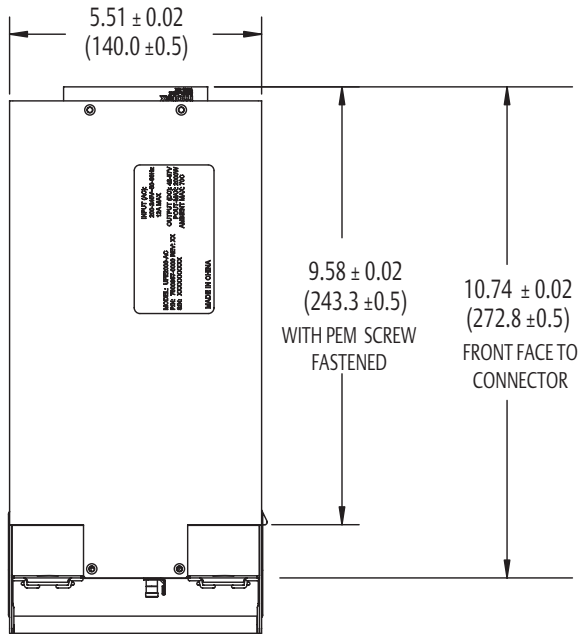

Dimensions in Inches (mm)

Power Supply Connector	Mating Connector
Molex: 87663-4006	Molex: 87664-2004
Tyco: 2-1450330-8	Tyco: 1450370-5
FCI Berg: 51939-180	FCI Berg: 51915-070

Power Supply Connector Pinout					
Pin	D	C	B	A	
P1				L1	
P2				L2	
P3				PEG	
1	Sense-	Sense+		GND	Shortpin
2	Present-L	GND		PS-ID0	GND
3	PS-ID3	PS-ID2		GND	12V-AUX
4	GND	SCL		PS-ID1	GND
5	SDA	GND		GND	I ² C-En-H (Comm-En-H)
6	SMBALERT#	Ishare		DC-OK-L	PS-EN (Control)
P4				DC_N	
P5				DC_N	
P6				DC_P	
P7				DC_P	

Power Supply Connector

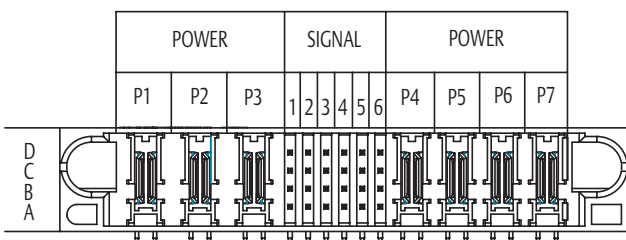

Power Connections Layout
(Looking into Connector Side of UFE Power Supply)

Rack Specifications

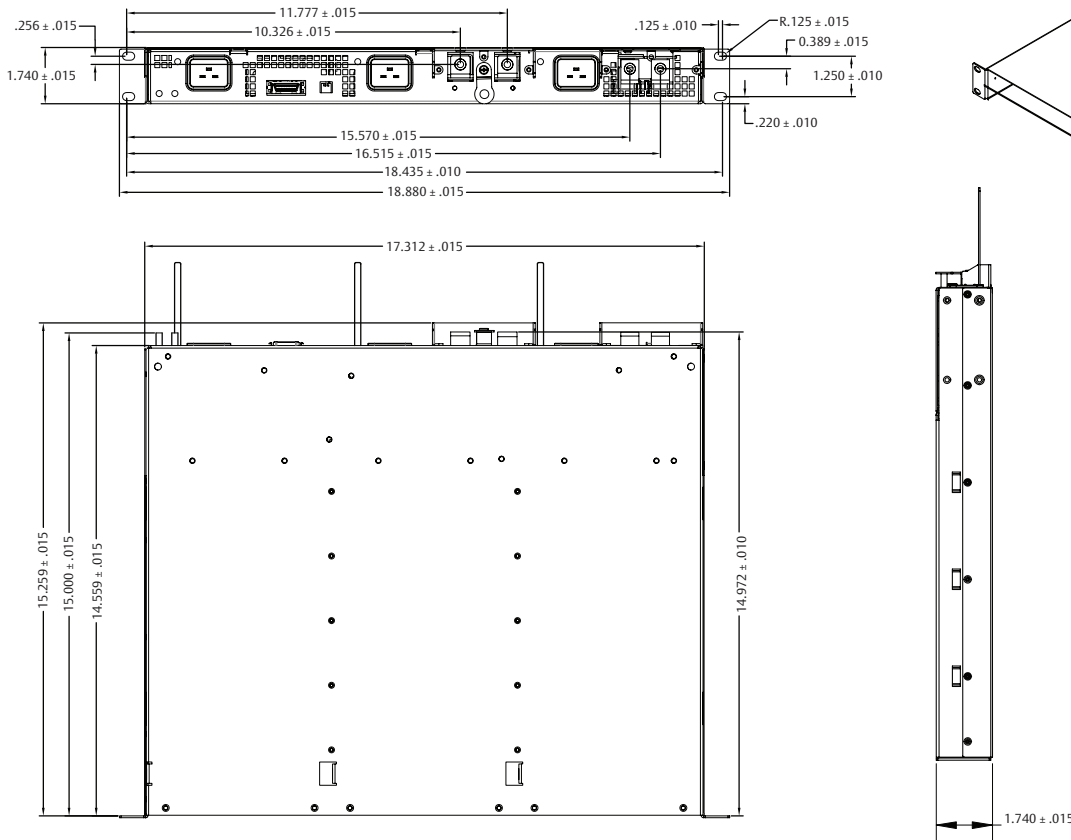

Rack Signal Connector Pinout			
Pin No.	Function	Pin No.	Function
1	48V Sense+	14	48V Ishare
2	Ground	15	Unit 1 Present
3	48V Sense-	16	Ground
4	Ground	17	Unit 2 Present
5	PS-EN (Control)	18	Ground
6	DC1-OK-L	19	Unit 3 Present
7	DC2-OK-L	20	Ground
8	DC3-OK-L	21	SCL
9	I ² C-En-H-1 (Comm-En-H)	22	Ground
10	I ² C-En-H-2 (Comm-En-H)	23	SDA
11	I ² C-En-H-3 (Comm-En-H)	24	Ground
12	Ground	25	SMBALERT#
13	12V-Aux	26	N/C

Signal Connector (1 per shelf)	
Shelf Connector	Mating Connector
Molex: 52986-2679	Molex: 52316-2619
Tyco: 2-178238-4	Tyco: 2-5175677-4

AC Input Connector (3 per shelf)	
Shelf Connector	Mating Connector
IEC320 C20 Socket	IEC320 C20 Plug (Straight Entry)

Shelf DIP Switch Table		
Shelf Number	DIP Switch	DIP Switch
1	Up	Up
2	Up	Down
3	Down	Up
4	Down	Down

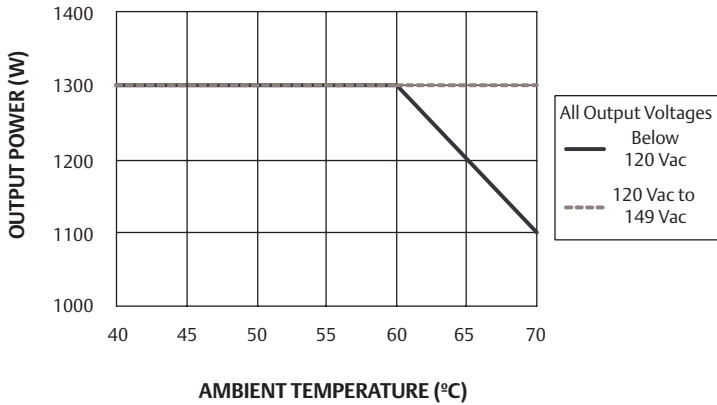

Figure 1 - Thermal Derating Curve for UFE2000-96S48J Model
Low Line Input Voltage

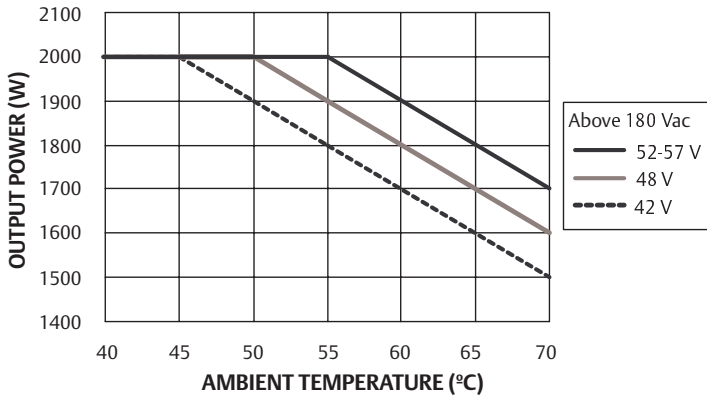

Figure 2 - Thermal Derating Curve for UFE2000-96S48J Model
High Line Input Voltage

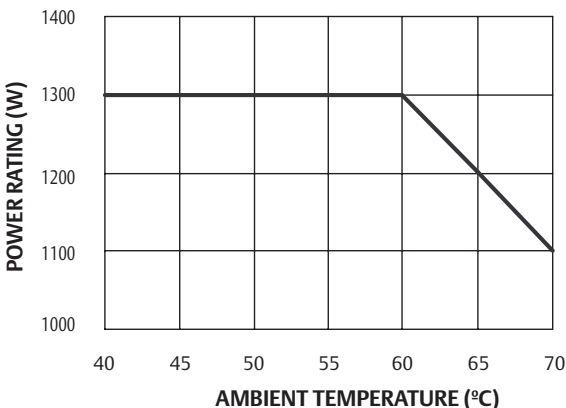

Figure 3 - Thermal Derating Curve for UFE1300-96S24J Model
All Conditions

Americas

5810 Van Allen Way
Carlsbad, CA 92008
USA
Telephone: +1 760 930 4600
Facsimile: +1 760 930 0698

Europe (UK)

Waterfront Business Park
Merry Hill, Dudley
West Midlands, DY5 1LX
United Kingdom
Telephone: +44 (0) 1384 842 211
Facsimile: +44 (0) 1384 843 355

Asia (HK)

14/F, Lu Plaza
2 Wing Yip Street
Kwun Tong, Kowloon
Hong Kong
Telephone: +852 2176 3333
Facsimile: +852 2176 3888

For global contact, visit:

www.Emerson.com/EmbeddedPower
techsupport.embeddedpower@emerson.com

While every precaution has been taken to ensure accuracy and completeness in this literature, Emerson Network Power assumes no responsibility, and disclaims all liability for damages resulting from use of this information or for any errors or omissions.

Emerson Network Power.

The global leader in enabling
business-critical continuity.

- AC Power
- Connectivity
- DC Power
- Embedded Computing
- Embedded Power
- Monitoring
- Outside Plant
- Power Switching & Controls
- Precision Cooling
- Racks & Integrated Cabinets
- Services
- Surge Protection

EmersonNetworkPower.com

Emerson Network Power and the Emerson Network Power logo are trademarks and service marks of Emerson Electric Co.
©2011 Emerson Electric Co.