



Chipsmall Limited consists of a professional team with an average of over 10 year of expertise in the distribution of electronic components. Based in Hongkong, we have already established firm and mutual-benefit business relationships with customers from,Europe,America and south Asia,supplying obsolete and hard-to-find components to meet their specific needs.

With the principle of “Quality Parts,Customers Priority,Honest Operation,and Considerate Service”,our business mainly focus on the distribution of electronic components. Line cards we deal with include Microchip,ALPS,ROHM,Xilinx,Pulse,ON,Everlight and Freescale. Main products comprise IC,Modules,Potentiometer,IC Socket,Relay,Connector.Our parts cover such applications as commercial,industrial, and automotives areas.

We are looking forward to setting up business relationship with you and hope to provide you with the best service and solution. Let us make a better world for our industry!



Contact us

Tel: +86-755-8981 8866 Fax: +86-755-8427 6832

Email & Skype: info@chipsmall.com Web: www.chipsmall.com

Address: A1208, Overseas Decoration Building, #122 Zhenhua RD., Futian, Shenzhen, China



PIN DIODE

For Microstrip 900MHz Antenna Switches and Microwave Applications

Features

- Low Inductance Shunt Mount Package
- Characterized for Microstrip
- Microsemi Ruggedness and Reliability
- High Power Handling Capability
- Low Bias Current Requirement
- Excellent Distortion Properties
- Cost Effective in High Quantity Applications

6

Description

The UM9601-UM9608 series of PIN diodes was developed for shunt mount applications in microstrip circuits. Good switch performance is demonstrated at frequencies from UHF to 4GHz and higher. This performance is achieved using discrete low inductance Microsemi PIN diodes assembled with special hardware to permit good electrical and mechanical compatibility with microstrip transmission lines.

Design information is presented for preparation of microstrip circuit boards to accommodate these PIN diodes. A detailed design for a 900MHz quarter-wave antenna switch is given. This switch which employs a low cost UM9401 axial leaded PIN diode in conjunction with a UM9601, performs with 30dB receiver isolation over a 100MHz bandwidth and with transmitter insertion loss of less than 0.4dB. This switch can safely handle transmitter power levels up to 100 watts at infinite antenna SWR.

The Microsemi UM9601 series PIN diodes are constructed using a fused-in-glass process which results in a highly reliable, hermetic package. The process utilizes symmetrical, full faced metallurgical bonds to both surfaces of the silicon chip. This construction greatly minimizes the normal parasitic inductance and capacitance found in conventional glass or ceramic packaged diodes which employ straps, springs or whiskers.

The use of discrete UM9601-UM9608 diodes greatly minimizes handling problems commonly associated with passivated PIN diode chips while maintaining good microwave performance. In addition the power handling capability of the UM9601-UM9608 series is considerably higher than PIN diode chips can provide.

Environmentally, the UM9601-UM9608 series PIN diodes can withstand thermal cycling from -195°C to +300°C and exceed all military environmental specifications for shock, vibration, acceleration and moisture.

Typical Microwave Performance

Frequency	UM9601-UM9604			UM9605-UM9608		
	SPST Insertion Loss 0 Bias	SPST Isolation 100mA	SPNT* Isolation 100mA	SPST Insertion Loss 0 Bias	SPST Isolation 100mA	SPNT* Isolation 100mA
GHz	dB	dB	dB	dB	dB	dB
0.5	0.20	30	36	0.20	25	31
1.0	0.25	26	32	0.20	22	28
1.5	0.35	22	28	0.20	20	26
2.0	0.50	18	24	0.25	17	22
3.0	1.00	15	21	0.25	15	21
4.0	1.50	13	19	0.40	14	20

* Performance based on SPST Measurements
In 0.025" (.635mm) Microstrip Test Circuit.

Note: All dimensions in inches and (millimeters).

Maximum Ratings

	UM9601 - UM9604		UM9605 - UM9608	
	P _D	θ	P _D	θ
Flange at 25° C	7.5W	20° C/W	4W	37.5° C/W
Free Air	1.5W	—	0.5W	—

Reverse Voltage Ratings @ 10μA

100V	400V
UM9601	UM9602
UM9603	UM9604
UM9605	UM9606
UM9607	UM9608

Peak Power 1μS Single Pulse at 25° C Ambient	25KW	10KW
---	------	------

Operating and Storage Temperature	-65° C to +175° C
--	-------------------

Electrical Specifications (at 25° C)

Test	Symbol	UM9601-UM9604			UM9605-UM9608			Units	Condition
		Min	Typ	Max	Min	Typ	Max		
Series Resistance	R _S	—	0.4	0.6	—	1.5	1.7	Ω	I = 100mA f = 100MHz
Parallel Resistance	R _P	100K	—	—	150K	—	—	Ω	V = 100V f = 100MHz
Total Capacitance	C _T	—	—	1.2	—	—	0.5	pF	V = 100V f = 1MHz
Carrier Lifetime	τ	2.0	—	—	1.0	—	—	μS	I _F = 10mA
Forward Voltage	V _F	—	0.85	—	—	0.95	—	V	I _F = 100mA
I-Region Width	W	80	—	—	150	—	—	μm	

Selection Guide

The following chart serves as a general guide for indicating the most likely diode from the series for a given application.

Applications	Recommended Types
1. High isolation switches to 2GHz at low dc drive 2. Quarter-wave antenna switches to 100 watts. 3. Priced for high volume commercial applications.	UM9601 (Affixes to microstrip ground plane.) UM9603 (Affixes to microstrip backing plate.)
High voltage rating version of UM9601 and UM9603 respectively for peak power handling to 3KW.	UM9602, UM9604
1. Low insertion loss switches to 4GHz. 2. Low distortion attenuator applications.	UM9605 (Affixes to microstrip ground plane.) UM9607 (Affixes to microstrip backing plate.)
High voltage version of UM9605 and UM9607 for peak power handling to 10KW.	UM9606, UM9608

Typical Series Resistance vs Forward Current (F = 100MHz)

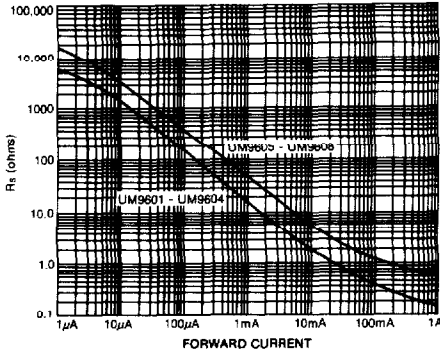

Pulse Thermal Impedance

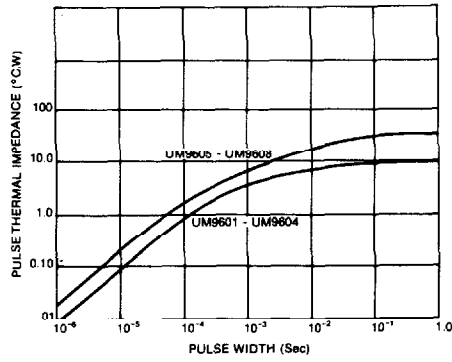

Typical R_p vs Voltage and Frequency UM9601 - UM9604

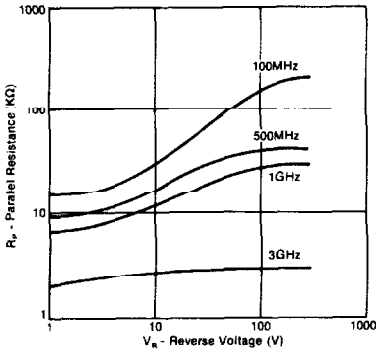

Power Rating

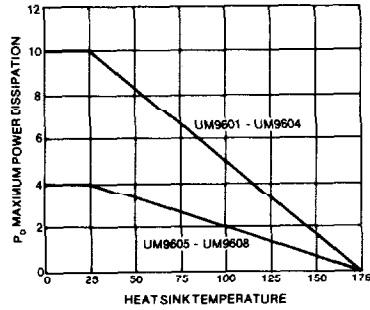

Typical R_p vs Voltage and Frequency UM9605 - UM9608

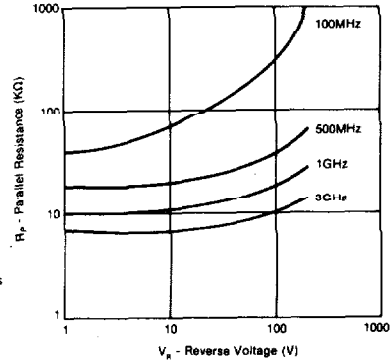

Typical Forward Bias Intermodulation Distortion vs Nominal Carrier Frequency at 20dBm per Channel

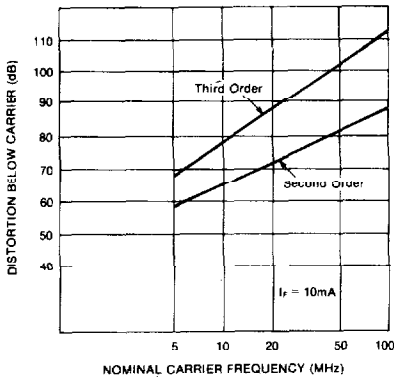

Typical Third Order Intermodulation Distortion ($R_{\frac{2ab}{a}}$) vs Forward Bias Current at 20dBm per Channel

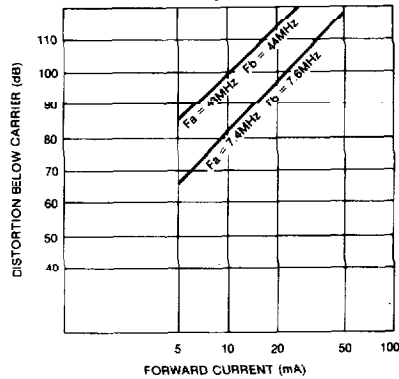

Mechanical Specifications

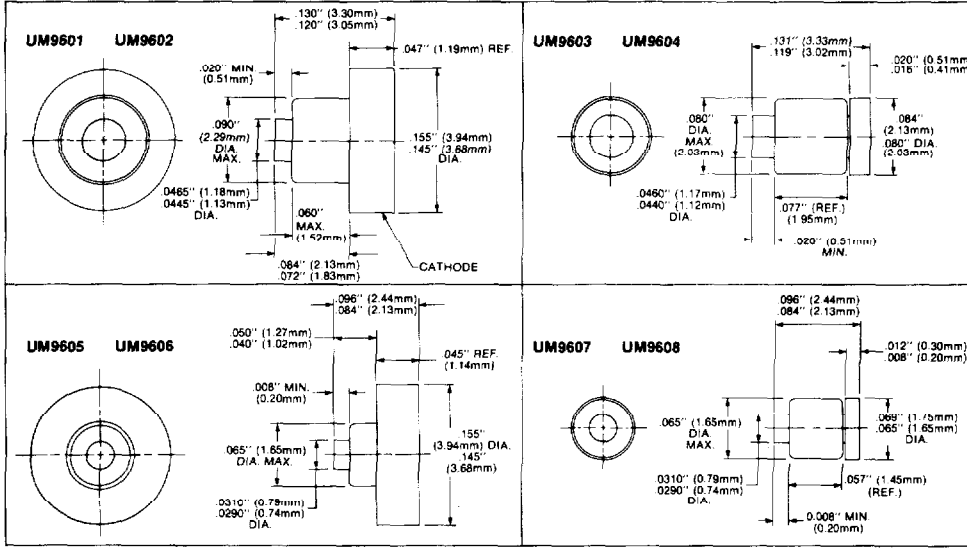

Typical Forward Bias

Third Order Intermodulation Distortion (R_{ab}) vs Input Power per Channel

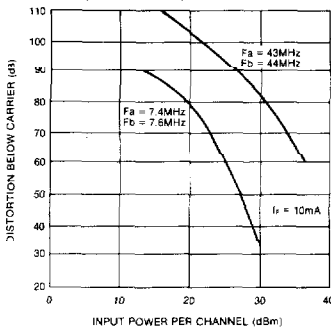

Typical Reverse Bias Intermodulation Distortion

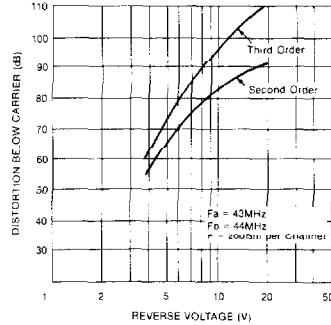

Mechanical Specifications

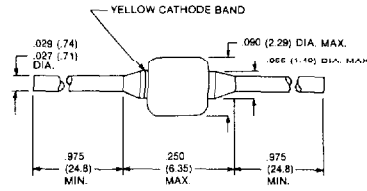

Forward Bias Distortion Test Set

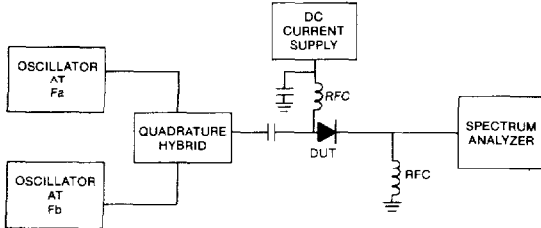

Reverse Bias Distortion Test Set

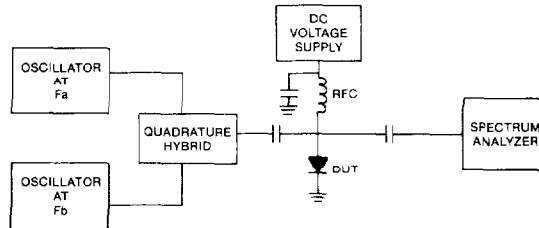

Microwave Characterization

The UM9601-UM9608 series has been designed and characterized as shunt switch elements at frequencies to 4GHz in microstrip circuits. Performance curves are given which demonstrate switch performance in 0.025" (.635mm) alumina microstrip.

The performance data were derived by evaluating externally biased microstrip circuits in which a UM9601 diode was installed. Each circuit consisted of a 1 inch length of 50 ohm nominal impedance 0.025" (.635mm) thick alumina microstrip and two SMA connectors. The data shown include the board and connector loss. Measurements performed using 0.050" (1.27mm) alumina substrates show similar performance at frequencies to 1.5GHz.

These circuits simulate simple SPST switches. Many designs require multithrow switches. It is important to recognize that a multithrow switch will have 6dB higher isolation than indicated for SPST switches. Also, a multithrow switch using shunt mounted PIN diodes require the diodes be placed a quarter-wavelength from the common port.

A further improvement in switch performance may be achieved by using 2 shunt PIN diodes in each arm spaced a quarter-wavelength from each other. In this case the isolation of each section will be twice the dB value of a SPST switch. The insertion loss due to the diodes should be less than twice the insertion loss of an SPST section due to the transforming effect of the quarter-wave line on the capacitance of a single diode.

6

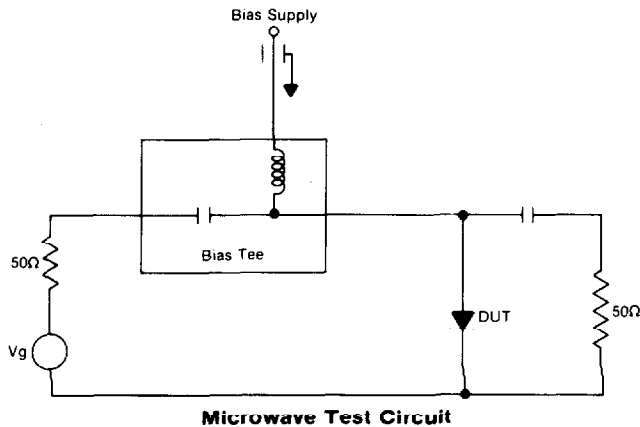

Typical Insertion Loss vs Frequency
0.025" (0.635mm) Alumina Microstrip SPST Switch
Diode at Zero Bias

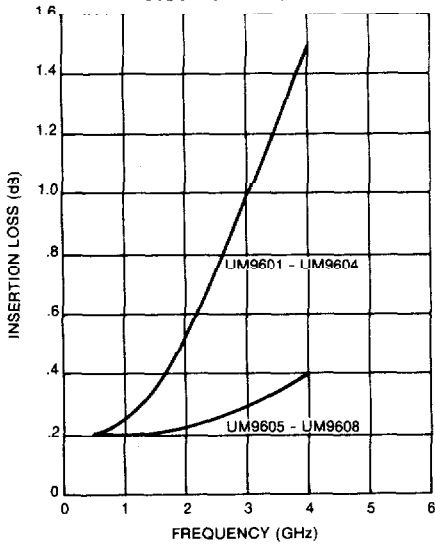

Typical Isolation vs Frequency
0.025" (0.635mm) Alumina Microstrip SPST Switch
Diode Current = 100mA

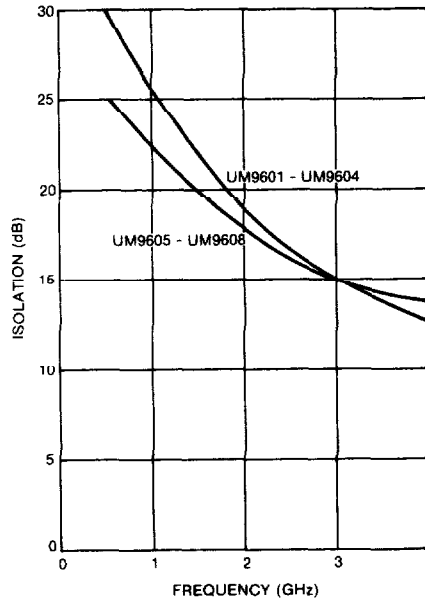

Isolation vs Frequency and Diode Current
0.025" (0.635mm) Alumina Microstrip SPST Switch

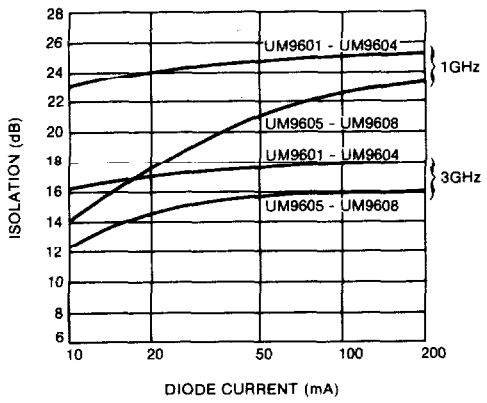

Installation in Microstrip

The cup type flange on the UM9601, UM9602, UM9605 and UM9606 is designed to be affixed to the ground plane surface of a microstrip board as shown. The UM9603, UM9604, UM9607 and UM9608 were designed to be affixed to a backing plate as shown. It was experimentally determined that at frequencies greater than 2GHz the anode of the diode should be approximately 0.010" (.254mm) above the top surface of the microstrip for lowest insertion loss.

For solder adhesion the microstrip may be heated to solder melting temperature (up to 300°C) with no damage to the diode. Conductive epoxy may also be employed. The thermal resistance of solder mounted UM9601-UM9604 in their test boards was less than 20° C/W; for the UM9605-UM9608 thermal resistance was less than 30° C/W.

6

**UM9601/UM9602
UM9605/UM9606**

Microstrip Mount

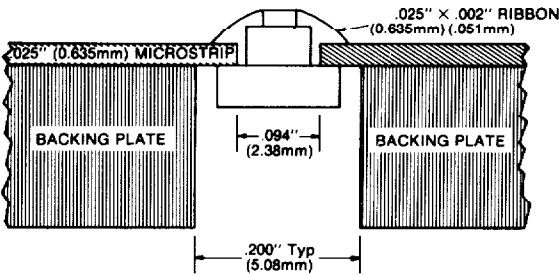

**UM9603/UM9604
UM9607/UM9608**

Microstrip Mount

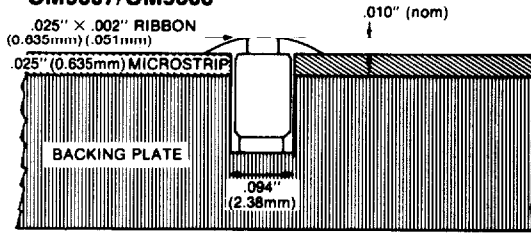

Design Example - 900MHz Antenna Switch

An example of a practical circuit design using a UM9601 diode is a quarter-wave antenna switch covering the frequency of 800-900MHz. The circuit design for this switch is shown and was constructed using 0.025" (0.645mm) alumina microstrip.

This antenna switch uses a series mounted diode and a shunt mounted diode. The UM9601 was selected for the shunt mounted device (SPST performance at 1GHz: 0.2dB insertion loss and 25dB isolation) and because it is the lowest cost diode in the UM9601-UM9608 series. A UM9401 axial lead diode was chosen for the series mounted device.

The performance of this switch is displayed in the graphs and in the following table. It should be noted that the loss values are actual measured numbers including losses due to the capacitors, bias networks, connectors as well as the board. In a typical radio application where the antenna switch circuit board is integrated in the same microstrip board that contains transmitter and receiver elements the connector loss is eliminated. This will result in lower overall insertion loss values than indicated here.

The CW power handling capacity is determined by the allowable power dissipation of the series mounted UM9401. Using a gap in the line of 0.190" (4.82mm) and lead soldered attached spacing of 0.250" (0.635mm) the power rating of the UM9401 is 6 watts at a 25°C ambient. This was determined by performing a thermal resistance measurement on the circuit mounted UM9401. The relationship that derives the maximum transmitter power, P_T is:

$$P_T = \frac{P_{Diss}}{R^s} Z_o \left(\frac{\sigma + 1}{2\sigma} \right)^2$$

where σ = maximum antenna SWR

Using resistance values for the UM9401 and UM9601 the maximum transmitter power curve is given and shows that this circuit is able to handle 100 watts of transmitter power at 100mA forward biased and totally mismatched antenna at an ambient temperature of 60°C. For a perfectly matched antenna the power handling increases to 400 watts under the same bias and ambient temperature conditions.

Distortion is an important consideration in the selection of a PIN diode antenna switch design. The UM9401 and UM9601 PIN diodes are designed for low distortion applications. The level of distortion produced by this 900MHz antenna switch when operated in the transmit

state (forward bias of 100mA) is expected to be at least 90dB below the carrier for a 50 watt transmitter level. In the receiver state (zero bias) the intermodulation distortion caused by two in-band signals at 0dBm are estimated to be at least 100dB below this level.

Maximum Transmitter Power vs Forward Current for UM9601/UM9401 900MHz Microstrip Antenna Switch

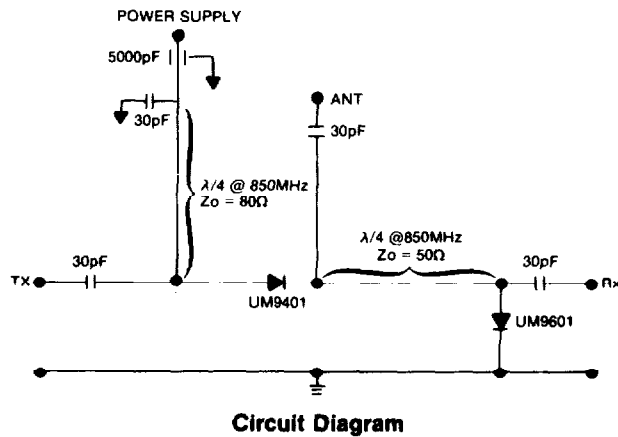
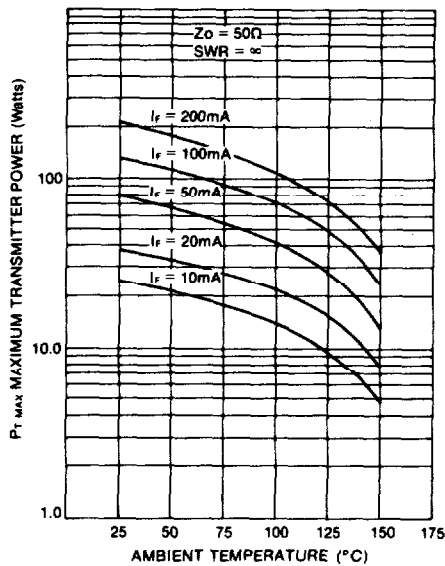

Antenna Switch Performance

Frequency Range 800-900MHz

I. Transmit State

($I = 100\text{mA}$, $T_A = 60^\circ\text{C}$)

- A. Maximum Transmitter Power - 100 watts (antenna SWR = ∞)
- B. Maximum Transmitter Power - 400 watts (antenna SWR = 1)
- C. Transmitter Insertion Loss - 0.4dB
- D. Receiver Isolation - 31dB
- E. Harmonic Distortion - -90dB ($P_T = 100$ watts)

II. Receive State

(Zero Bias)

- A. Receiver Insertion Loss - 0.6-0.7dB
- B. Intermodulation Distortion - -100dB ($P_{in} = 0\text{dBm}$)

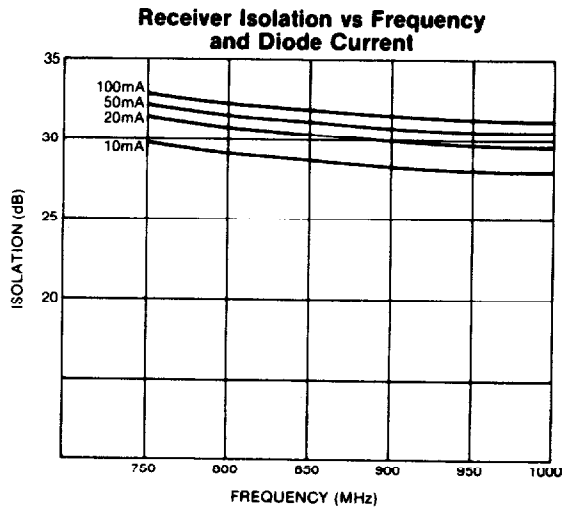
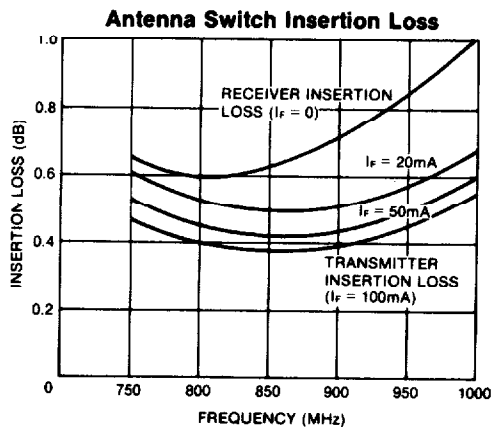

6

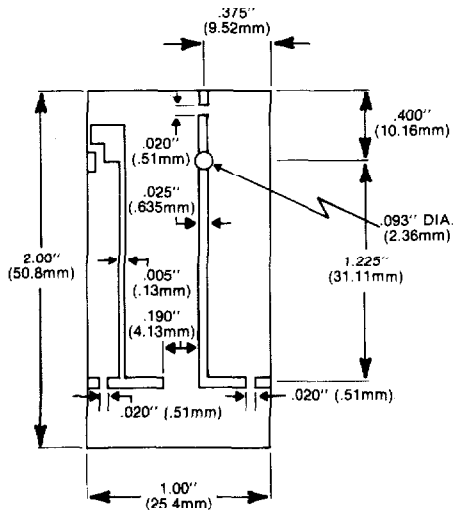

Substrate Drawing

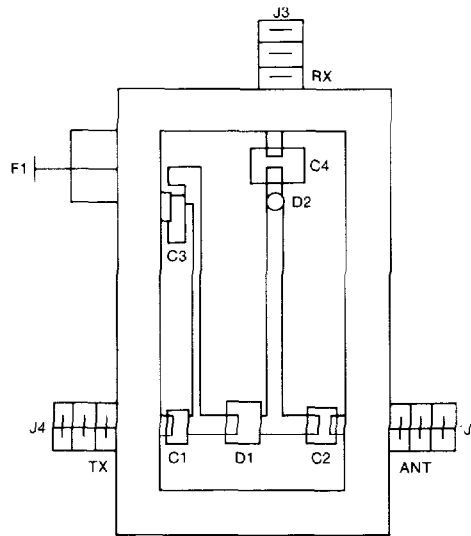

Assembly Drawing

Parts List

F1	5000pF Feed through Filter	Erie 1270-016
C1-C4	30pF Chip Capacitor	Vitramon VJ0805A300KF
D1	PIN Diode	Unitrode UM9401
D2	PIN Diode	Unitrode UM9601
J1-J3	SMA Connector	Cablewave 971-028
	Substrate	Vectronics Microwave 79-9081-0401