



Chipsmall Limited consists of a professional team with an average of over 10 year of expertise in the distribution of electronic components. Based in Hongkong, we have already established firm and mutual-benefit business relationships with customers from,Europe,America and south Asia,supplying obsolete and hard-to-find components to meet their specific needs.

With the principle of “Quality Parts,Customers Priority,Honest Operation,and Considerate Service”,our business mainly focus on the distribution of electronic components. Line cards we deal with include Microchip,ALPS,ROHM,Xilinx,Pulse,ON,Everlight and Freescale. Main products comprise IC,Modules,Potentiometer,IC Socket,Relay,Connector.Our parts cover such applications as commercial,industrial, and automotives areas.

We are looking forward to setting up business relationship with you and hope to provide you with the best service and solution. Let us make a better world for our industry!



Contact us

Tel: +86-755-8981 8866 Fax: +86-755-8427 6832

Email & Skype: info@chipsmall.com Web: www.chipsmall.com

Address: A1208, Overseas Decoration Building, #122 Zhenhua RD., Futian, Shenzhen, China



NPN SILICON HIGH FREQUENCY TRANSISTOR

FEATURES

- **SMALL PACKAGE STYLE:**
2 NE685 Die in a 2 mm x 1.25 mm package
- **LOW NOISE FIGURE:**
NF = 1.5 dB TYP at 2 GHz
- **HIGH GAIN:**
 $IS_{21E}I^2 = 8.5$ dB TYP at 2 GHz
- **HIGH GAIN BANDWIDTH:** $f_T = 12$ GHz
- **EXCELLENT LOW VOLTAGE, LOW CURRENT PERFORMANCE**

DESCRIPTION

The UPA806T is two NPN high frequency silicon epitaxial transistors encapsulated in an ultra small 6 pin SMT package. Each transistor is independently mounted and easily configured for either dual transistor or cascode operation. The high f_T , low voltage bias and small size make this device suited for various hand-held wireless applications.

OUTLINE DIMENSIONS (Units in mm)

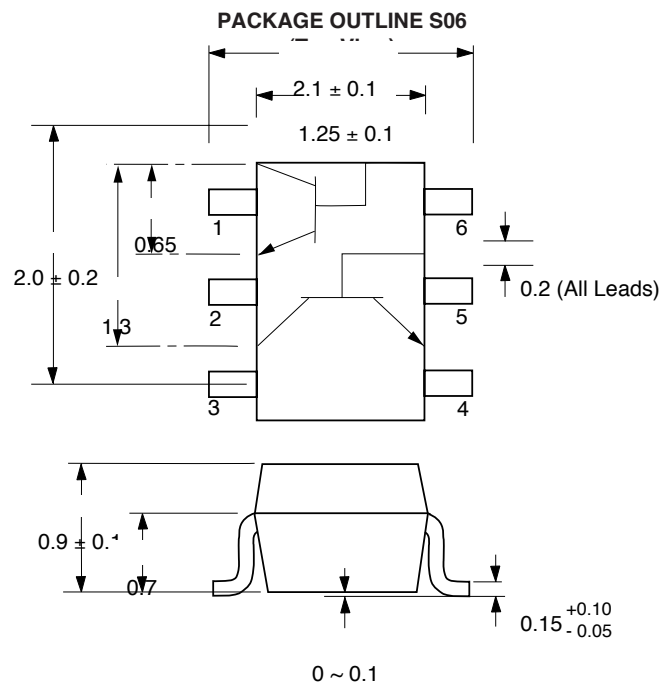

PIN OUT

1. Collector Transistor 1
2. Emitter Transistor 1
3. Collector Transistor 2
4. Emitter Transistor 2
5. Base Transistor 2
6. Base Transistor 1

Note:

Pin 3 is identified with a circle on the bottom of the package.

ELECTRICAL CHARACTERISTICS ($T_A = 25^\circ\text{C}$)

PART NUMBER PACKAGE OUTLINE			UPA806T S06		
SYMBOLS	PARAMETERS AND CONDITIONS	UNITS	MIN	TYP	MAX
I_{CBO}	Collector Cutoff Current at $V_{CB} = 5$ V, $I_E = 0$	μA			0.1
I_{EBO}	Emitter Cutoff Current at $V_{EB} = 1$ V, $I_C = 0$	μA			0.1
h_{FE}^1	Forward Current Gain at $V_{CE} = 3$ V, $I_C = 10$ mA		75	100	150
f_T	Gain Bandwidth at $V_{CE} = 3$ V, $I_C = 10$ mA, $f = 2$ GHz	GHz		12	
C_{re}^2	Feedback Capacitance at $V_{CB} = 3$ V, $I_E = 0$, $f = 1$ MHz	pF		0.4	0.7
$IS_{21E}I^2$	Insertion Power Gain at $V_{CE} = 3$ V, $I_C = 10$ mA, $f = 2$ GHz	dB	7	8.5	
NF	Noise Figure at $V_{CE} = 3$ V, $I_C = 3$ mA, $f = 2$ GHz	dB		1.5	2.5
h_{FE1}/h_{FE2}	h_{FE} Ratio: $h_{FE1} =$ Smaller Value of Q1, or Q2 $h_{FE2} =$ Larger Value of Q1 or Q2		0.85		

Notes: 1. Pulsed measurement, pulse width ≤ 350 μs , duty cycle $\leq 2\%$.

2. The emitter terminal should be connected to the ground terminal of the 3 terminal capacitance bridge.

For Tape and Reel version use part number UPA806T-T1, 3K per reel.

ABSOLUTE MAXIMUM RATINGS¹ (T_A = 25°C)

SYMBOLS	PARAMETERS	UNITS	RATINGS
V _{CBO}	Collector to Base Voltage	V	9
V _{CEO}	Collector to Emitter Voltage	V	6
V _{EBO}	Emitter to Base Voltage	V	2
I _C	Collector Current	mA	30
PT	Total Power Dissipation		
	1 Die	mW	110
	2 Die	mW	200
T _J	Junction Temperature	°C	150
T _{STG}	Storage Temperature	°C	-65 to +150

Note: 1. Operation in excess of any one of these parameters may result in permanent damage.

ORDERING INFORMATION

PART NUMBER	QUANTITY	PACKAGING
UPA806T-T1-A	3000	Tape & Reel

TYPICAL PERFORMANCE CURVES

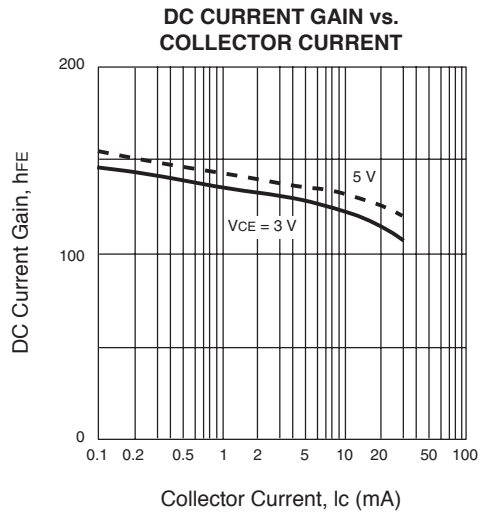
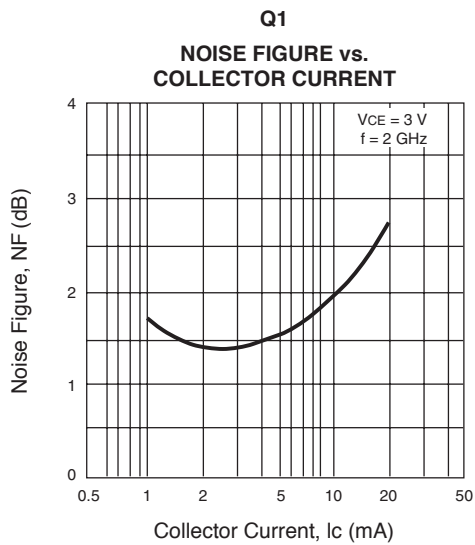
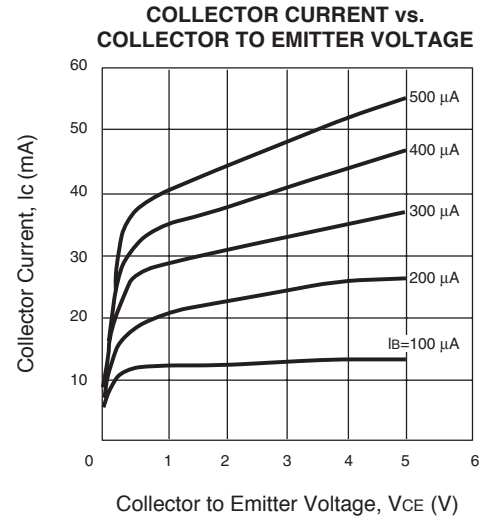
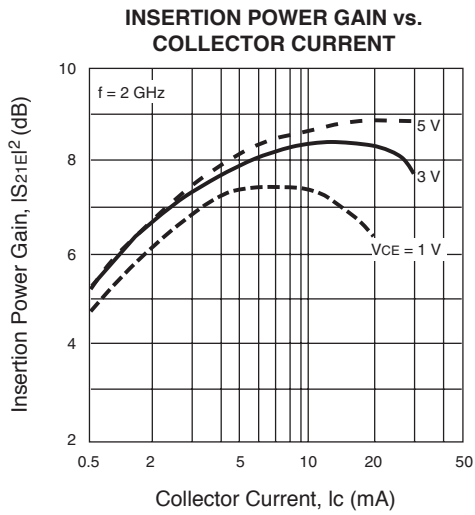

TYPICAL PERFORMANCE CURVES

GAIN BANDWIDTH PRODUCT vs. COLLECTOR CURRENT

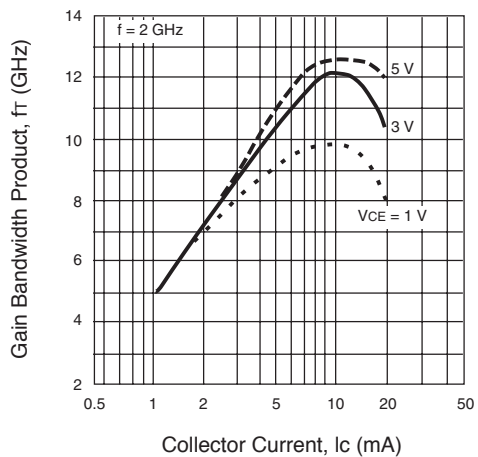

FEEDBACK CAPACITANCE vs. COLLECTOR TO BASE VOLTAGE

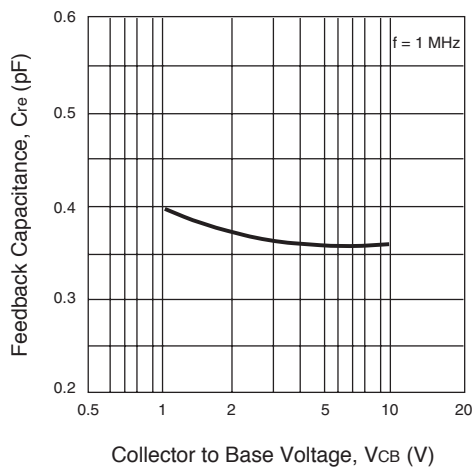

TOTAL POWER DISSIPATION vs. AMBIENT TEMPERATURE

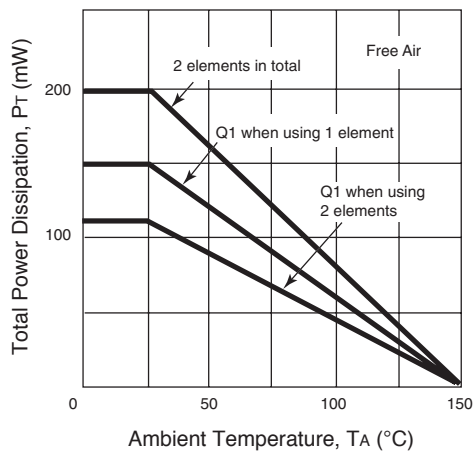

COLLECTOR CURRENT vs. BASE TO EMITTER VOLTAGE

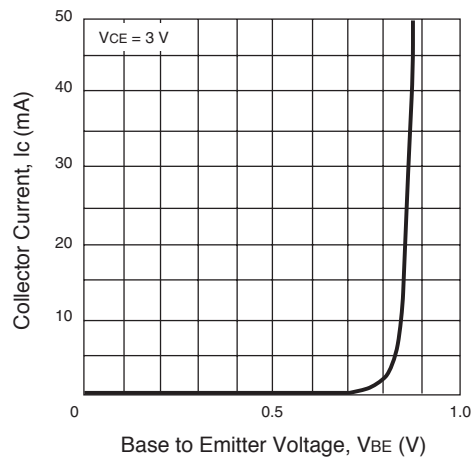

UPA806T

TYPICAL SCATTERING PARAMETERS (T_A = 25°C)

UPA806T(Q1)

V_{CE} = 1 V, I_C = 1 mA

FREQUENCY (GHz)	S ₁₁		S ₂₁		S ₁₂		S ₂₂		K	G _{mag} (dB)
	MAG	ANG	MAG	ANG	MAG	ANG	MAG	ANG		
0.50	0.893	-33.80	2.828	145.80	0.098	67.30	0.933	-20.90	0.218	14.603
0.60	0.846	-40.80	2.750	139.10	0.116	62.10	0.911	-24.50	0.282	13.749
0.80	0.766	-53.80	2.615	127.20	0.145	54.30	0.867	-31.20	0.365	12.561
1.00	0.693	-65.70	2.486	116.60	0.169	47.80	0.823	-37.40	0.435	11.676
1.20	0.624	-76.80	2.354	106.90	0.187	42.10	0.778	-43.20	0.502	11.000
1.40	0.558	-87.70	2.221	97.90	0.201	37.10	0.735	-48.70	0.568	10.434
1.60	0.498	-98.60	2.093	89.40	0.212	32.70	0.694	-53.90	0.633	9.944
1.80	0.445	-109.60	1.973	81.30	0.220	28.90	0.656	-58.90	0.699	9.527
2.00	0.400	-120.50	1.865	73.90	0.226	25.70	0.621	-63.60	0.764	9.166
2.20	0.362	-131.30	1.766	67.00	0.229	23.20	0.591	-68.00	0.830	8.872
2.40	0.329	-142.00	1.677	60.90	0.232	21.30	0.565	-72.00	0.893	8.590
2.60	0.301	-152.90	1.593	55.30	0.233	20.00	0.542	-75.80	0.960	8.349
2.80	0.279	-165.00	1.515	50.10	0.234	18.90	0.523	-79.30	1.022	7.202
3.00	0.268	-179.10	1.445	44.80	0.235	18.10	0.506	-82.70	1.076	6.207

UPA806T(Q2)

V_{CE} = 1 V, I_C = 1 mA

FREQUENCY (GHz)	S ₁₁		S ₂₁		S ₁₂		S ₂₂		K	G _{mag} (dB)
	MAG	ANG	MAG	ANG	MAG	ANG	MAG	ANG		
0.50	0.899	-34.10	2.832	145.80	0.090	66.90	0.937	-20.70	0.210	14.979
0.60	0.856	-41.10	2.755	139.20	0.106	61.70	0.916	-24.20	0.272	14.148
0.80	0.783	-54.00	2.622	127.40	0.134	53.60	0.873	-30.80	0.357	12.915
1.00	0.717	-65.70	2.495	116.80	0.155	47.10	0.831	-36.90	0.424	12.067
1.20	0.655	-76.60	2.367	107.10	0.172	41.30	0.789	-42.60	0.490	11.387
1.40	0.595	-87.00	2.239	98.00	0.185	36.10	0.747	-48.00	0.559	10.829
1.60	0.540	-97.20	2.116	89.50	0.196	31.60	0.707	-53.10	0.625	10.333
1.80	0.490	-107.20	2.001	81.40	0.204	27.60	0.670	-58.10	0.692	9.916
2.00	0.447	-116.90	1.898	73.80	0.210	24.20	0.635	-62.80	0.760	9.561
2.20	0.408	-126.30	1.804	66.80	0.215	21.50	0.604	-67.40	0.825	9.238
2.40	0.372	-135.40	1.719	60.40	0.218	19.20	0.577	-71.70	0.893	8.968
2.60	0.339	-144.60	1.640	54.50	0.220	17.50	0.552	-75.90	0.962	8.724
2.80	0.311	-154.90	1.565	48.90	0.221	16.00	0.531	-80.00	1.028	7.467
3.00	0.290	-167.50	1.497	43.20	0.223	14.60	0.511	-84.00	1.087	6.474

Note:

1. Gain Calculation:

$$\text{MAG} = \frac{|S_{21}|}{|S_{12}|} \left(K \pm \sqrt{K^2 - 1} \right). \text{ When } K \leq 1, \text{ MAG is undefined and MSG values are used. } \text{MSG} = \frac{|S_{21}|}{|S_{12}|}, K = \frac{1 + |\Delta|^2 - |S_{11}|^2 - |S_{22}|^2}{2 |S_{12}| |S_{21}|}, \Delta = S_{11} S_{22} - S_{21} S_{12}$$

MAG = Maximum Available Gain

MSG = Maximum Stable Gain

TYPICAL SCATTERING PARAMETERS (T_A = 25°C)

UPA806T(Q1)

V_{CE} = 2 V, I_C = 5 mA

FREQUENCY (GHz)	S ₁₁		S ₂₁		S ₁₂		S ₂₂		K	G _{mag} (dB)
	MAG	ANG	MAG	ANG	MAG	ANG	MAG	ANG		
0.50	0.537	-62.90	8.804	121.00	0.064	60.90	0.710	-34.60	0.533	21.385
0.60	0.464	-68.80	7.894	115.70	0.071	59.00	0.664	-36.80	0.617	20.460
0.80	0.351	-81.80	6.511	105.20	0.085	56.60	0.587	-40.90	0.744	18.842
1.00	0.272	-95.90	5.539	95.50	0.097	55.20	0.529	-44.70	0.837	17.567
1.20	0.216	-110.40	4.820	87.10	0.110	54.10	0.485	-48.20	0.901	16.417
1.40	0.176	-125.30	4.250	80.20	0.123	53.20	0.451	-51.40	0.949	15.385
1.60	0.146	-140.60	3.778	74.60	0.135	52.40	0.425	-54.30	0.992	14.469
1.80	0.124	-156.90	3.381	69.80	0.148	51.40	0.404	-57.20	1.028	12.563
2.00	0.112	-174.00	3.055	65.40	0.161	50.40	0.387	-60.00	1.057	11.326
2.20	0.109	169.30	2.800	61.00	0.174	49.20	0.372	-63.00	1.077	10.374
2.40	0.113	154.50	2.612	56.40	0.187	47.90	0.360	-66.20	1.085	9.676
2.60	0.124	142.00	2.477	51.70	0.201	46.50	0.349	-69.70	1.078	9.199
2.80	0.140	131.40	2.371	47.00	0.214	44.90	0.339	-73.40	1.069	8.836
3.00	0.162	121.50	2.249	42.80	0.226	43.20	0.329	-77.10	1.069	8.380

UPA806T(Q2)

V_{CE} = 2 V, I_C = 5 mA

FREQUENCY (GHz)	S ₁₁		S ₂₁		S ₁₂		S ₂₂		K	G _{mag} (dB)
	MAG	ANG	MAG	ANG	MAG	ANG	MAG	ANG		
0.50	0.562	-61.50	8.997	121.90	0.059	60.70	0.729	-33.10	0.516	21.832
0.60	0.491	-67.40	8.086	116.40	0.066	58.50	0.683	-35.20	0.602	20.882
0.80	0.383	-80.00	6.704	105.60	0.078	55.70	0.608	-39.20	0.733	19.342
1.00	0.307	-92.90	5.732	95.60	0.089	54.00	0.550	-42.80	0.830	18.089
1.20	0.253	-105.30	5.008	87.10	0.101	52.70	0.506	-46.00	0.895	16.953
1.40	0.212	-117.00	4.429	79.90	0.112	51.70	0.472	-48.90	0.950	15.971
1.60	0.179	-128.10	3.945	74.00	0.124	50.70	0.445	-51.40	0.993	15.026
1.80	0.153	-139.00	3.536	68.90	0.136	49.60	0.423	-53.90	1.031	13.065
2.00	0.132	-150.50	3.200	64.20	0.148	48.40	0.404	-56.50	1.064	11.801
2.20	0.118	-162.90	2.937	59.50	0.160	47.10	0.388	-59.30	1.087	10.839
2.40	0.111	-176.20	2.744	54.60	0.173	45.70	0.374	-62.40	1.093	10.141
2.60	0.110	169.90	2.608	49.60	0.185	44.00	0.361	-65.80	1.093	9.637
2.80	0.115	155.50	2.501	44.80	0.198	42.30	0.348	-69.50	1.083	9.254
3.00	0.127	140.60	2.376	40.20	0.210	40.30	0.336	-73.40	1.083	8.783

Note:

1. Gain Calculation:

$$\text{MAG} = \frac{|S_{21}|}{|S_{12}|} (K \pm \sqrt{K^2 - 1}). \text{ When } K \leq 1, \text{ MAG is undefined and MSG values are used. } \text{MSG} = \frac{|S_{21}|}{|S_{12}|}, K = \frac{1 + |\Delta|^2 - |S_{11}|^2 - |S_{22}|^2}{2 |S_{12}| |S_{21}|}, \Delta = S_{11} S_{22} - S_{21} S_{12}$$

MAG = Maximum Available Gain

MSG = Maximum Stable Gain

UPA806T

TYPICAL SCATTERING PARAMETERS (TA = 25°C)

UPA806T(Q1)

VCE = 2 V, IC = 10 mA

FREQUENCY (GHz)	S11		S21		S12		S22		K	Gmag (dB)
	MAG	ANG	MAG	ANG	MAG	ANG	MAG	ANG		
0.50	0.323	-79.50	10.650	109.10	0.054	63.40	0.567	-37.90	0.754	22.950
0.60	0.270	-85.10	9.383	105.00	0.061	63.30	0.532	-38.90	0.812	21.870
0.80	0.190	-99.30	7.445	96.40	0.074	62.90	0.473	-41.00	0.910	20.026
1.00	0.137	-118.00	6.111	88.00	0.089	62.30	0.430	-43.40	0.968	18.367
1.20	0.107	-140.80	5.181	80.50	0.103	61.40	0.398	-46.10	1.010	16.405
1.40	0.095	-164.50	4.507	74.50	0.118	60.30	0.374	-48.90	1.032	14.716
1.60	0.093	174.40	3.991	69.90	0.133	59.00	0.357	-51.80	1.047	13.443
1.80	0.096	157.30	3.581	66.10	0.148	57.50	0.343	-54.80	1.059	12.352
2.00	0.103	143.70	3.247	62.70	0.162	55.90	0.332	-57.90	1.071	11.392
2.20	0.113	132.80	2.977	58.90	0.177	54.20	0.322	-61.10	1.076	10.577
2.40	0.125	124.10	2.763	54.50	0.192	52.30	0.312	-64.50	1.076	9.896
2.60	0.141	116.90	2.597	49.50	0.206	50.40	0.302	-68.20	1.073	9.353
2.80	0.159	110.80	2.465	44.30	0.221	48.40	0.293	-72.20	1.063	8.942
3.00	0.181	105.10	2.330	40.10	0.234	46.40	0.284	-76.40	1.061	8.476

UPA806T(Q2)

VCE = 2 V, IC = 10 mA

FREQUENCY (GHz)	S11		S21		S12		S22		K	Gmag (dB)
	MAG	ANG	MAG	ANG	MAG	ANG	MAG	ANG		
0.50	0.348	-77.00	11.024	109.80	0.050	62.90	0.590	-36.20	0.739	23.434
0.60	0.297	-82.40	9.724	105.50	0.056	62.50	0.554	-37.10	0.803	22.397
0.80	0.218	-95.00	7.740	96.50	0.068	61.80	0.495	-39.10	0.905	20.562
1.00	0.165	-110.00	6.376	87.80	0.081	61.00	0.451	-41.20	0.971	18.961
1.20	0.131	-126.30	5.424	80.10	0.095	60.00	0.419	-43.40	1.009	16.991
1.40	0.111	-142.60	4.728	73.90	0.108	58.80	0.395	-45.70	1.037	15.227
1.60	0.098	-158.20	4.192	68.90	0.122	57.40	0.377	-48.10	1.054	13.945
1.80	0.090	-172.90	3.761	64.90	0.135	55.80	0.363	-50.60	1.071	12.828
2.00	0.086	173.10	3.411	61.20	0.149	54.10	0.350	-53.20	1.081	11.860
2.20	0.086	159.80	3.129	57.10	0.163	52.20	0.338	-56.10	1.088	11.023
2.40	0.091	147.40	2.909	52.40	0.177	50.20	0.326	-59.20	1.089	10.335
2.60	0.101	136.10	2.743	47.10	0.191	48.10	0.314	-62.70	1.084	9.804
2.80	0.115	126.00	2.611	41.80	0.205	45.90	0.302	-66.50	1.075	9.382
3.00	0.134	116.50	2.474	37.20	0.218	43.60	0.291	-70.70	1.071	8.922

Note:

1. Gain Calculation:

$$MAG = \frac{|S_{21}|}{|S_{12}|} \left(K \pm \sqrt{K^2 - 1} \right). \text{ When } K \leq 1, \text{ MAG is undefined and MSG values are used. } MSG = \frac{|S_{21}|}{|S_{12}|}, K = \frac{1 + |\Delta|^2 - |S_{11}|^2 - |S_{22}|^2}{2 |S_{12}| |S_{21}|}, \Delta = S_{11} S_{22} - S_{21} S_{12}$$

MAG = Maximum Available Gain

MSG = Maximum Stable Gain

TYPICAL SCATTERING PARAMETERS (T_A = 25°C)

UPA806T(Q1)

V_{CE} = 3 V, I_C = 10 mA

FREQUENCY (GHz)	S ₁₁		S ₂₁		S ₁₂		S ₂₂		K	Gmag (dB)
	MAG	ANG	MAG	ANG	MAG	ANG	MAG	ANG		
0.50	0.337	-74.20	10.935	110.20	0.052	64.10	0.589	-35.80	0.744	23.228
0.60	0.283	-79.00	9.644	106.00	0.058	64.00	0.554	-36.70	0.807	22.208
0.80	0.198	-90.80	7.669	97.40	0.072	63.60	0.496	-38.80	0.898	20.274
1.00	0.139	-106.30	6.308	88.90	0.086	62.90	0.453	-41.10	0.959	18.654
1.20	0.101	-126.10	5.356	81.50	0.100	62.00	0.421	-43.70	0.999	17.288
1.40	0.080	-149.80	4.662	75.50	0.114	60.90	0.398	-46.30	1.024	15.163
1.60	0.071	-174.60	4.129	70.90	0.128	59.70	0.381	-49.10	1.042	13.832
1.80	0.072	163.30	3.704	67.10	0.143	58.30	0.367	-52.00	1.052	12.741
2.00	0.077	145.60	3.358	63.70	0.157	56.70	0.356	-54.90	1.063	11.767
2.20	0.087	132.20	3.078	60.00	0.172	55.10	0.346	-58.00	1.067	10.946
2.40	0.100	122.10	2.857	55.70	0.186	53.30	0.336	-61.20	1.070	10.253
2.60	0.115	114.40	2.687	50.70	0.200	51.40	0.327	-64.70	1.066	9.717
2.80	0.135	108.10	2.550	45.60	0.214	49.50	0.318	-68.40	1.057	9.301
3.00	0.157	102.50	2.411	41.50	0.227	47.50	0.309	-72.30	1.054	8.834

UPA806T(Q2)

V_{CE} = 3 V, I_C = 10 mA

FREQUENCY (GHz)	S ₁₁		S ₂₁		S ₁₂		S ₂₂		K	Gmag (dB)
	MAG	ANG	MAG	ANG	MAG	ANG	MAG	ANG		
0.50	0.364	-71.90	11.322	111.00	0.047	63.60	0.613	-34.10	0.734	23.818
0.60	0.311	-76.60	9.999	106.60	0.053	63.20	0.578	-35.00	0.797	22.757
0.80	0.228	-87.40	7.979	97.60	0.066	62.50	0.520	-36.90	0.891	20.824
1.00	0.170	-99.80	6.588	88.80	0.078	61.70	0.477	-39.00	0.960	19.267
1.20	0.131	-113.50	5.613	81.20	0.091	60.70	0.445	-41.10	1.001	17.712
1.40	0.105	-127.60	4.897	74.90	0.104	59.50	0.422	-43.30	1.027	15.721
1.60	0.086	-141.90	4.341	70.00	0.117	58.20	0.404	-45.70	1.047	14.372
1.80	0.073	-156.70	3.895	66.00	0.130	56.60	0.390	-48.10	1.062	13.244
2.00	0.065	-172.60	3.531	62.30	0.143	55.00	0.378	-50.60	1.074	12.260
2.20	0.063	170.60	3.239	58.30	0.157	53.20	0.367	-53.40	1.079	11.433
2.40	0.065	154.00	3.012	53.60	0.171	51.20	0.355	-56.40	1.079	10.738
2.60	0.074	139.20	2.841	48.40	0.184	49.20	0.344	-59.70	1.076	10.205
2.80	0.088	126.60	2.705	43.10	0.197	47.00	0.333	-63.30	1.068	9.784
3.00	0.107	115.70	2.563	38.60	0.210	44.80	0.322	-67.30	1.064	9.320

Note:

1. Gain Calculation:

$$\text{MAG} = \frac{|S_{21}|}{|S_{12}|} \left(K \pm \sqrt{K^2 - 1} \right). \text{ When } K \leq 1, \text{ MAG is undefined and MSG values are used. } \text{MSG} = \frac{|S_{21}|}{|S_{12}|}, K = \frac{1 + |\Delta|^2 - |S_{11}|^2 - |S_{22}|^2}{2 |S_{12}| |S_{21}|}, \Delta = S_{11} S_{22} - S_{21} S_{12}$$

MAG = Maximum Available Gain

MSG = Maximum Stable Gain

NONLINEAR MODEL

BJT NONLINEAR MODEL PARAMETERS(1)

Parameters	Q1 & Q2	Parameters	Q1 & Q2
IS	7e-16	MJC	0.34
BF	109	XCJC	0
NF	1	CJS	0
VAF	15	VJS	0.75
IKF	0.19	MJS	0
ISE	7.9e-13	FC	0.5
NE	2.19	TF	3e-12
BR	1	XTF	5.2
NR	1.08	VTF	4.58
VAR	12.4	ITF	0.01
IKR	Infinity	PTF	0
ISC	0	TR	1e-9
NC	2	EG	1.11
RE	1.3	XTB	0
RB	10	XTI	3
RBM	8.34	KF	0
IRB	0.009	AF	1
RC	10		
CJE	0.4e-12		
VJE	0.81		
MJE	0.5		
CJC	0.18e-12		
VJC	0.75		

(1) Gummel-Poon Model

UNITS

Parameter	Units
time	seconds
capacitance	farads
inductance	henries
resistance	ohms
voltage	volts
current	amps

MODEL RANGE

Frequency: 0.1 to 3.0 GHz
 Bias: $V_{CE} = 0.5 \text{ V to } 5 \text{ V}$, $I_C = 1 \text{ mA to } 10 \text{ mA}$
 Date: 10/98

Note:

This nonlinear model utilized the latest data available. See our Design Parameter Library at www.cel.com for this data.

NONLINEAR MODEL

SCHEMATIC

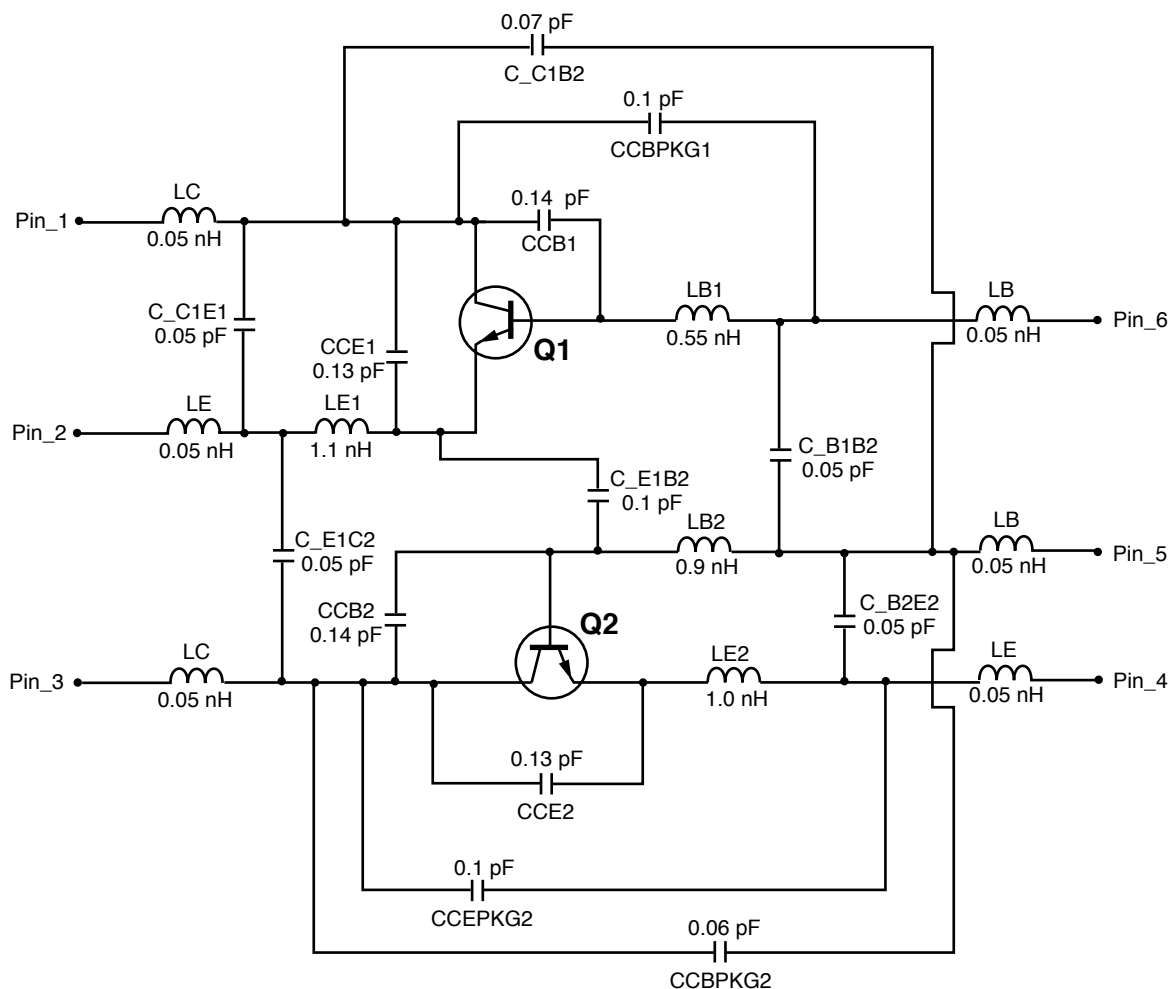

MODEL RANGE

Frequency: 0.1 to 3.0 GHz
 Bias: $V_{CE} = 0.5 \text{ V to } 5 \text{ V}$, $I_c = 1 \text{ mA to } 10 \text{ mA}$
 Date: 10/98

EXCLUSIVE NORTH AMERICAN AGENT FOR RF, MICROWAVE & OPTOELECTRONIC SEMICONDUCTORS

CEL CALIFORNIA EASTERN LABORATORIES • Headquarters • 4590 Patrick Henry Drive • Santa Clara, CA 95054-1817 • (408) 988-3500 • Telex 34-6393 • FAX (408) 988-0279
 24-Hour Fax-On-Demand: 800-390-3232 (U.S. and Canada only) • Internet: <http://WWW.CEL.COM>

DATA SUBJECT TO CHANGE WITHOUT NOTICE

PRINTED IN USA ON RECYCLED PAPER - 12/98