



Chipsmall Limited consists of a professional team with an average of over 10 year of expertise in the distribution of electronic components. Based in Hongkong, we have already established firm and mutual-benefit business relationships with customers from,Europe,America and south Asia,supplying obsolete and hard-to-find components to meet their specific needs.

With the principle of “Quality Parts,Customers Priority,Honest Operation,and Considerate Service”,our business mainly focus on the distribution of electronic components. Line cards we deal with include Microchip,ALPS,ROHM,Xilinx,Pulse,ON,Everlight and Freescale. Main products comprise IC,Modules,Potentiometer,IC Socket,Relay,Connector.Our parts cover such applications as commercial,industrial, and automotives areas.

We are looking forward to setting up business relationship with you and hope to provide you with the best service and solution. Let us make a better world for our industry!



## Contact us

Tel: +86-755-8981 8866 Fax: +86-755-8427 6832

Email & Skype: info@chipsmall.com Web: www.chipsmall.com

Address: A1208, Overseas Decoration Building, #122 Zhenhua RD., Futian, Shenzhen, China



### L, S-BAND SPDT SWITCH

#### DESCRIPTION

The  $\mu$ PG2158T5K is a GaAs MMIC for L, S-band SPDT (Single Pole Double Throw) switch which was developed for mobile phone and another L, S-band application.

This device can operate 2 control switching by control voltage 1.8 to 5.3 V. This device can operate frequency from 0.05 to 3.0 GHz, having the low insertion loss and high isolation.

This device is housed in a 6-pin plastic TSSON (Thin Shrink Small Out-line Non-leaded) package. And this package is able to high-density surface mounting.

#### FEATURES

- Switch control voltage :  $V_{\text{cont (H)}} = 1.8$  to  $5.3$  V (2.7 V TYP.)  
:  $V_{\text{cont (L)}} = -0.2$  to  $+0.2$  V (0 V TYP.)
- Low insertion loss :  $L_{\text{INS1}} = 0.40$  dB TYP. @  $f = 0.05$  to  $1.0$  GHz,  $V_{\text{cont (H)}} = 2.7$  V,  $V_{\text{cont (L)}} = 0$  V  
:  $L_{\text{INS2}} = 0.45$  dB TYP. @  $f = 1.0$  to  $2.0$  GHz,  $V_{\text{cont (H)}} = 2.7$  V,  $V_{\text{cont (L)}} = 0$  V  
:  $L_{\text{INS3}} = 0.47$  dB TYP. @  $f = 2.0$  to  $2.5$  GHz,  $V_{\text{cont (H)}} = 2.7$  V,  $V_{\text{cont (L)}} = 0$  V  
:  $L_{\text{INS4}} = 0.53$  dB TYP. @  $f = 2.5$  to  $3.0$  GHz,  $V_{\text{cont (H)}} = 2.7$  V,  $V_{\text{cont (L)}} = 0$  V
- High isolation :  $ISL1 = 27$  dB TYP. @  $f = 0.05$  to  $1.0$  GHz,  $V_{\text{cont (H)}} = 2.7$  V,  $V_{\text{cont (L)}} = 0$  V  
:  $ISL2 = 19$  dB TYP. @  $f = 1.0$  to  $2.0$  GHz,  $V_{\text{cont (H)}} = 2.7$  V,  $V_{\text{cont (L)}} = 0$  V  
:  $ISL3 = 17$  dB TYP. @  $f = 2.0$  to  $2.5$  GHz,  $V_{\text{cont (H)}} = 2.7$  V,  $V_{\text{cont (L)}} = 0$  V  
:  $ISL4 = 17$  dB TYP. @  $f = 2.5$  to  $3.0$  GHz,  $V_{\text{cont (H)}} = 2.7$  V,  $V_{\text{cont (L)}} = 0$  V
- Handling power :  $P_{\text{in (0.1 dB)}} = +29.0$  dBm TYP. @  $f = 2.0/2.5$  GHz,  $V_{\text{cont (H)}} = 2.7$  V,  $V_{\text{cont (L)}} = 0$  V  
:  $P_{\text{in (1 dB)}} = +30.5$  dBm TYP. @  $f = 2.0/2.5$  GHz,  $V_{\text{cont (H)}} = 2.7$  V,  $V_{\text{cont (L)}} = 0$  V
- High-density surface mounting : 6-pin plastic TSSON package ( $1.0 \times 1.0 \times 0.37$  mm)

#### APPLICATIONS

- L, S-band digital cellular or cordless telephone
- W-LAN, WLL and Bluetooth™ etc.

#### ORDERING INFORMATION

Part Number	Order Number	Package	Marking	Supplying Form
$\mu$ PG2158T5K-E2	$\mu$ PG2158T5K-E2-A	6-pin plastic TSSON (Pb-Free) <sup>Note</sup>	G2	<ul style="list-style-type: none"> <li>• Embossed tape 8 mm wide</li> <li>• Pin 1, 6 face the perforation side of the tape</li> <li>• Qty 5 kpcs/reel</li> </ul>

**Note** With regards to terminal solder (the solder contains lead) plated products (conventionally plated), contact your nearby sales office.

**Remark** To order evaluation samples, contact your nearby sales office.  
Part number for sample order:  $\mu$ PG2158T5K-A

**Caution** Observe precautions when handling because these devices are sensitive to electrostatic discharge.

The information in this document is subject to change without notice. Before using this document, please confirm that this is the latest version.

**PIN CONNECTIONS AND INTERNAL BLOCK DIAGRAM**

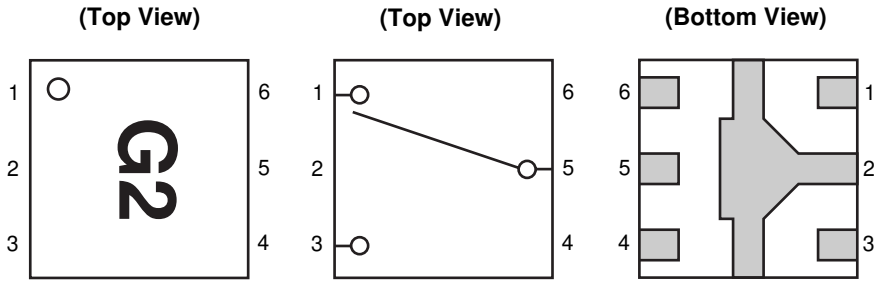

Pin No.	Pin Name
1	OUTPUT1
2	GND
3	OUTPUT2
4	V <sub>cont2</sub>
5	INPUT
6	V <sub>cont1</sub>

**TRUTH TABLE**

V <sub>cont1</sub>	V <sub>cont2</sub>	INPUT-OUTPUT1	INPUT-OUTPUT2
Low	High	OFF	ON
High	Low	ON	OFF

**ABSOLUTE MAXIMUM RATINGS (T<sub>A</sub> = +25°C, unless otherwise specified)**

Parameter	Symbol	Ratings	Unit
Switch Control Voltage	V <sub>cont</sub>	+6.0 <sup>Note</sup>	V
Input Power	P <sub>in</sub>	+31	dBm
Operating Ambient Temperature	T <sub>A</sub>	-45 to +85	°C
Storage Temperature	T <sub>stg</sub>	-55 to +150	°C

**Note** |V<sub>cont1</sub> - V<sub>cont2</sub>| ≤ 6.0 V

**RECOMMENDED OPERATING RANGE (T<sub>A</sub> = +25°C, unless otherwise specified)**

Parameter	Symbol	MIN.	TYP.	MAX.	Unit
Switch Control Voltage (H)	V <sub>cont (H)</sub>	1.8	2.7	5.3	V
Switch Control Voltage (L)	V <sub>cont (L)</sub>	-0.2	0	+0.2	V

**ELECTRICAL CHARACTERISTICS 1**

(T<sub>A</sub> = +25°C, V<sub>cont</sub> (H) = 2.7 V, V<sub>cont</sub> (L) = 0 V, DC cut capacitors = 56 pF, unless otherwise specified)

Parameter	Symbol	Test Conditions	MIN.	TYP.	MAX.	Unit
Insertion Loss 1	L <sub>INS1</sub>	f = 0.05 to 1.0 GHz <sup>Note 1</sup>	–	0.40	0.45	dB
Insertion Loss 2	L <sub>INS2</sub>	f = 1.0 to 2.0 GHz	–	0.45	0.50	
Insertion Loss 3	L <sub>INS3</sub>	f = 2.0 to 2.5 GHz	–	0.47	0.55	
Insertion Loss 4	L <sub>INS4</sub>	f = 2.5 to 3.0 GHz	–	0.53	0.60	
Isolation 1	ISL1	f = 0.05 to 1.0 GHz <sup>Note 1</sup>	23	27	–	dB
Isolation 2	ISL2	f = 1.0 to 2.0 GHz	16	19	–	
Isolation 3	ISL3	f = 2.0 to 2.5 GHz	14	17	–	
Isolation 4	ISL4	f = 2.5 to 3.0 GHz	14	17	–	
Input Return Loss	RL <sub>in</sub>	f = 0.05 to 3.0 GHz <sup>Note 1</sup>	15	20	–	dB
Output Return Loss	RL <sub>out</sub>	f = 0.05 to 3.0 GHz <sup>Note 1</sup>	15	20	–	dB
0.1 dB Loss Compression Input Power <sup>Note 2</sup>	P <sub>in</sub> (0.1 dB)	f = 2.0/2.5 GHz	+26.0	+29.0	–	dBm
		f = 0.5 to 3.0 GHz	–	+29.0	–	
1 dB Loss Compression Input Power <sup>Note 3</sup>	P <sub>in</sub> (1 dB)	f = 0.5 to 3.0 GHz	–	+30.5	–	dBm
2nd Harmonics	2f <sub>0</sub>	f = 2.0/2.5 GHz, P <sub>in</sub> = +20 dBm	65	75	–	dBc
3rd Harmonics	3f <sub>0</sub>	f = 2.0/2.5 GHz, P <sub>in</sub> = +20 dBm	65	75	–	dBc
Input 3rd Order Distortion Intercept Point	IIP <sub>3</sub>	f = 0.5 to 3.0 GHz 2 tone 5 MHz spacing	–	+60	–	dBm
Switch Control Current	I <sub>cont</sub>	No signal	–	0.2	20	μA
Switch Control Speed	t <sub>sw</sub>	50% CTL to 90/10% RF	–	50	500	ns

**Notes 1.** DC cut capacitors = 1 000 pF at f = 0.05 to 0.5 GHz

**2.** P<sub>in</sub> (0.1 dB) is measured the input power level when the insertion loss increases more 0.1 dB than that of linear range.

**3.** P<sub>in</sub> (1 dB) is measured the input power level when the insertion loss increases more 1 dB than that of linear range.

**Caution** This device is used it is necessary to use DC cut capacitors.

The value of DC cut capacitors should be chosen to accommodate the frequency of operation, bandwidth, switching speed and the condition with actual board of your system. The range of recommended DC cut capacitor value is less than 100 pF.

**ELECTRICAL CHARACTERISTICS 2**

(T<sub>A</sub> = +25°C, V<sub>cont</sub> (H) = 1.8 V, V<sub>cont</sub> (L) = 0 V, DC cut capacitors = 56 pF, unless otherwise specified)

Parameter	Symbol	Test Conditions	MIN.	TYP.	MAX.	Unit
Insertion Loss 1	L <sub>INS1</sub>	f = 0.05 to 1.0 GHz <sup>Note 1</sup>	–	0.40	0.47	dB
Insertion Loss 2	L <sub>INS2</sub>	f = 1.0 to 2.0 GHz	–	0.46	0.52	
Insertion Loss 3	L <sub>INS3</sub>	f = 2.0 to 2.5 GHz	–	0.48	0.57	
Insertion Loss 4	L <sub>INS4</sub>	f = 2.5 to 3.0 GHz	–	0.54	0.62	
Isolation 1	ISL1	f = 0.05 to 1.0 GHz <sup>Note 1</sup>	23	27	–	dB
Isolation 2	ISL2	f = 1.0 to 2.0 GHz	16	19	–	
Isolation 3	ISL3	f = 2.0 to 2.5 GHz	14	17	–	
Isolation 4	ISL4	f = 2.5 to 3.0 GHz	14	17	–	
Input Return Loss	RL <sub>in</sub>	f = 0.05 to 3.0 GHz <sup>Note 1</sup>	15	20	–	dB
Output Return Loss	RL <sub>out</sub>	f = 0.05 to 3.0 GHz <sup>Note 1</sup>	15	20	–	dB
0.1 dB Loss Compression Input Power <sup>Note 2</sup>	P <sub>in (0.1 dB)</sub>	f = 2.0/2.5 GHz	+19.0	+22.0	–	dBm
		f = 0.5 to 3.0 GHz	–	+22.0	–	
1 dB Loss Compression Input Power <sup>Note 3</sup>	P <sub>in (1 dB)</sub>	f = 0.5 to 3.0 GHz	–	+25.0	–	dBm
Switch Control Current	I <sub>cont</sub>	No signal	–	0.2	20	μA
Switch Control Speed	t <sub>sw</sub>	50% CTL to 90/10% RF	–	50	500	ns

**Notes 1.** DC cut capacitors = 1 000 pF at f = 0.05 to 0.5 GHz

**2.** P<sub>in (0.1 dB)</sub> is measured the input power level when the insertion loss increases more 0.1 dB than that of linear range.

**3.** P<sub>in (1 dB)</sub> is measured the input power level when the insertion loss increases more 1 dB than that of linear range.

**Caution** This device is used it is necessary to use DC cut capacitors.

The value of DC cut capacitors should be chosen to accommodate the frequency of operation, bandwidth, switching speed and the condition with actual board of your system. The range of recommended DC cut capacitor value is less than 100 pF.

EVALUATION CIRCUIT

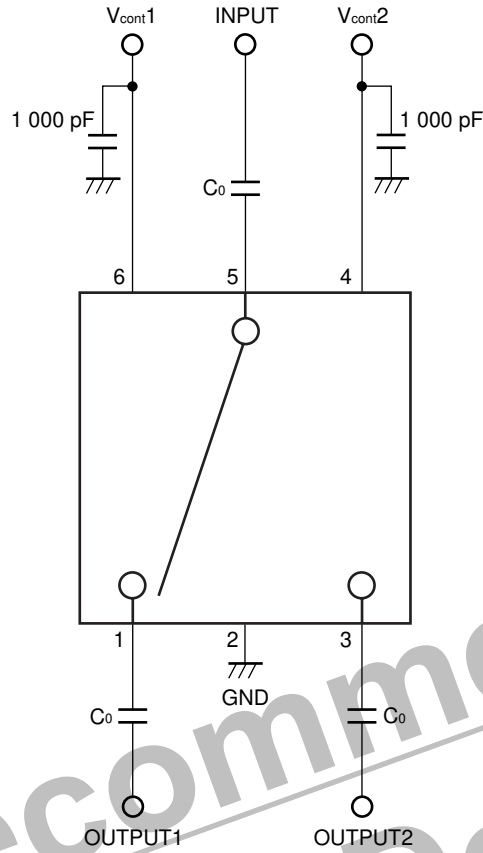

**Remark** C<sub>0</sub> : 0.05 to 0.5 GHz 1 000 pF  
 : 0.5 to 3.0 GHz 56 pF

The application circuits and their parameters are for reference only and are not intended for use in actual design-ins.

ILLUSTRATION OF THE TEST CIRCUIT ASSEMBLED ON EVALUATION BOARD

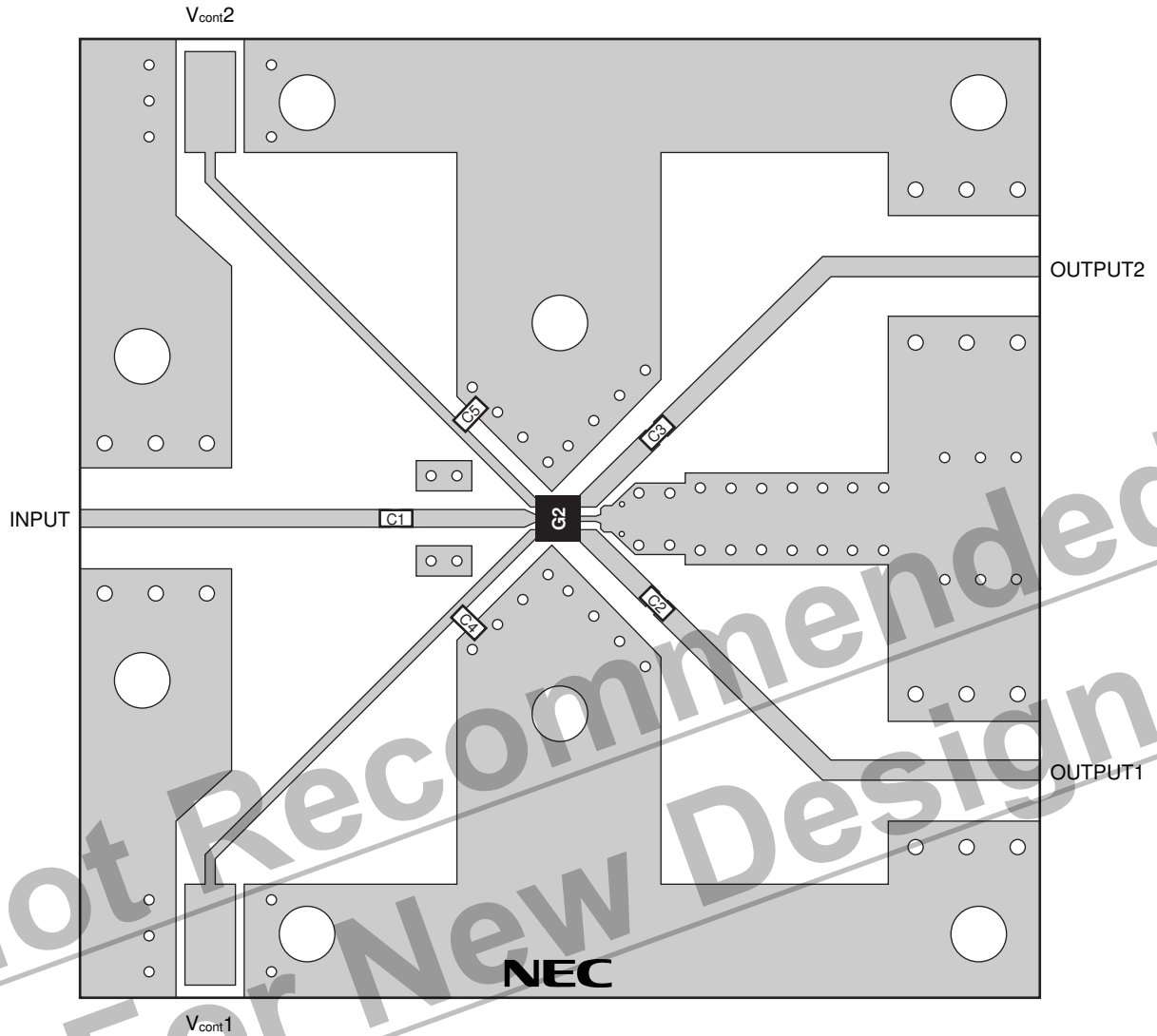

USING THE NEC EVALUATION BOARD

Symbol	Values
C1, C2, C3	56 pF
C4, C5	1 000 pF

**TYPICAL CHARACTERISTICS** ( $T_A = +25^\circ\text{C}$ ,  $V_{\text{cont}}(\text{H}) = 2.7\text{ V}$ ,  $V_{\text{cont}}(\text{L}) = 0\text{ V}$ , DC cut capacitors = 56 pF, using test fixture, unless otherwise specified)

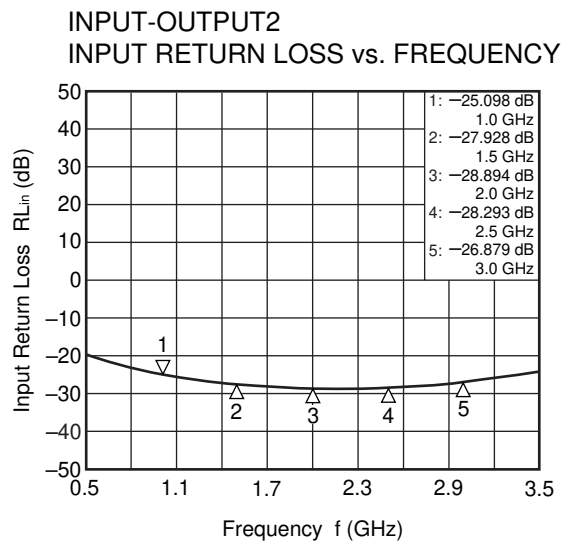
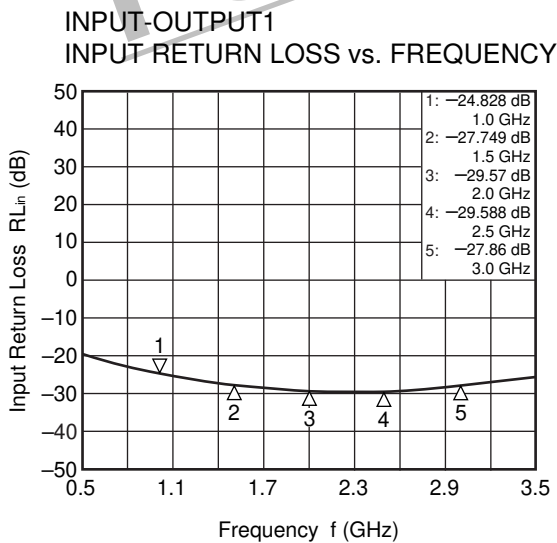
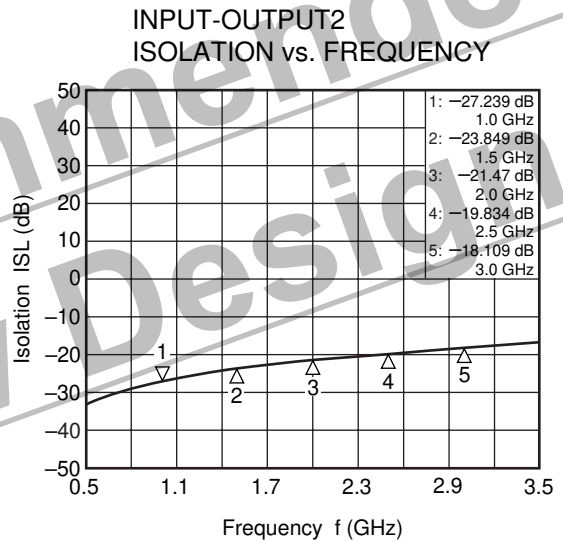
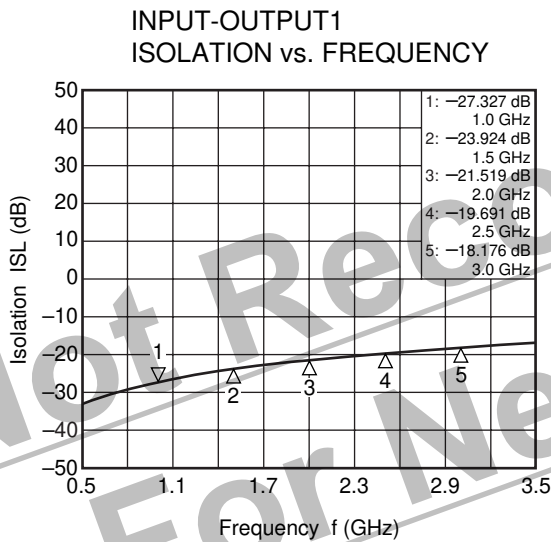
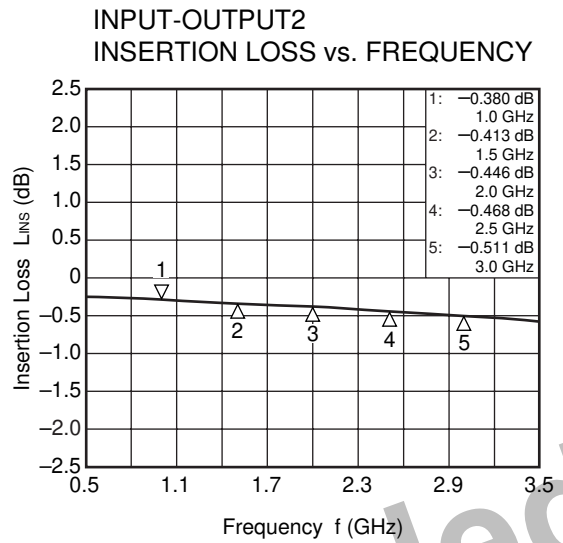
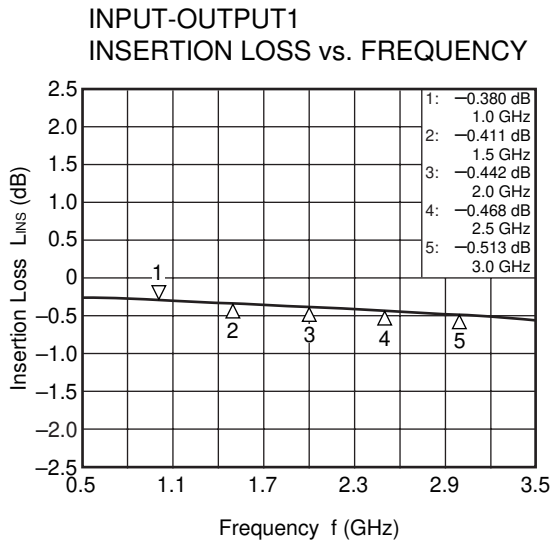

**Remark** The graphs indicate nominal characteristics.



INPUT-OUTPUT1  
OUTPUT RETURN LOSS vs. FREQUENCY

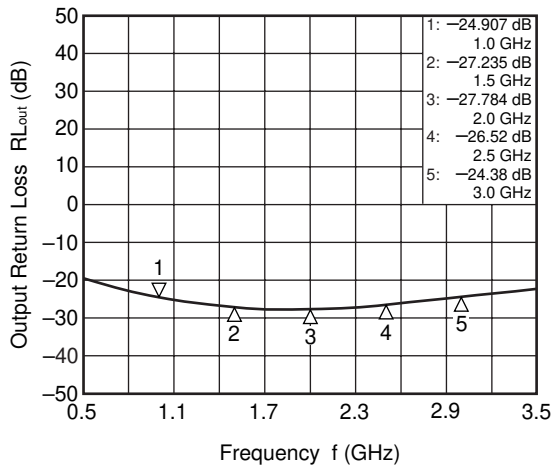

INPUT-OUTPUT2  
OUTPUT RETURN LOSS vs. FREQUENCY

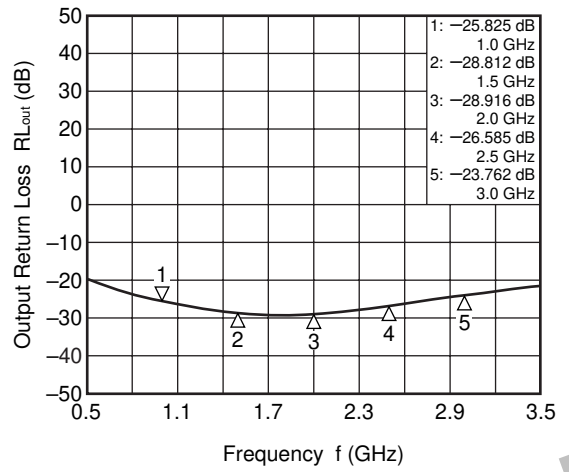

OUTPUT POWER vs. INPUT POWER

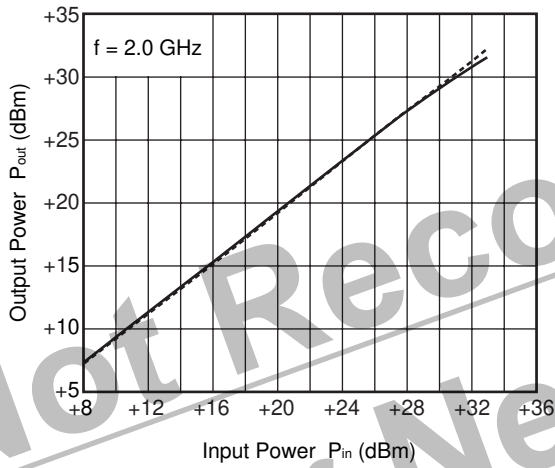

**Remark** The graphs indicate nominal characteristics.

Not Recommended For New Design

★ PACKAGE DIMENSIONS

6-PIN PLASTIC TSSOP (UNIT: mm)

(Top View)

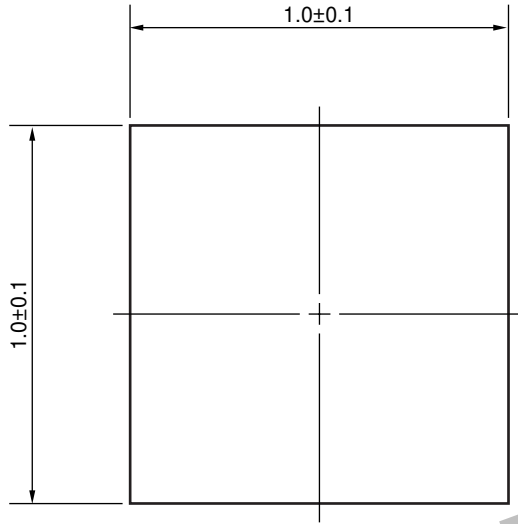

(Bottom View)

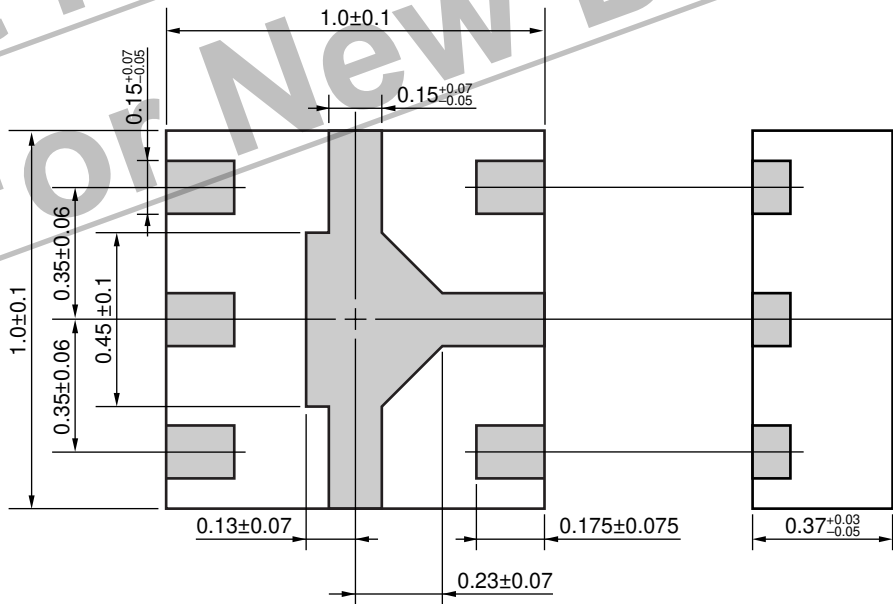

**RECOMMENDED SOLDERING CONDITIONS**

This product should be soldered and mounted under the following recommended conditions. For soldering methods and conditions other than those recommended below, contact your nearby sales office.

Soldering Method	Soldering Conditions	Condition Symbol
Infrared Reflow	Peak temperature (package surface temperature) : 260°C or below Time at peak temperature : 10 seconds or less Time at temperature of 220°C or higher : 60 seconds or less Preheating time at 120 to 180°C : 120±30 seconds Maximum number of reflow processes : 3 times Maximum chlorine content of rosin flux (% mass) : 0.2%(Wt.) or below	IR260
Wave Soldering	Peak temperature (molten solder temperature) : 260°C or below Time at peak temperature : 10 seconds or less Preheating temperature (package surface temperature) : 120°C or below Maximum number of flow processes : 1 time Maximum chlorine content of rosin flux (% mass) : 0.2%(Wt.) or below	WS260
Partial Heating	Peak temperature (terminal temperature) : 350°C or below Soldering time (per side of device) : 3 seconds or less Maximum chlorine content of rosin flux (% mass) : 0.2%(Wt.) or below	HS350

**Caution Do not use different soldering methods together (except for partial heating).**

*Not Recommended  
For New Design*

Subject: Compliance with EU Directives

CEL certifies, to its knowledge, that semiconductor and laser products detailed below are compliant with the requirements of European Union (EU) Directive 2002/95/EC Restriction on Use of Hazardous Substances in electrical and electronic equipment (RoHS) and the requirements of EU Directive 2003/11/EC Restriction on Penta and Octa BDE.

CEL Pb-free products have the same base part number with a suffix added. The suffix –A indicates that the device is Pb-free. The –AZ suffix is used to designate devices containing Pb which are exempted from the requirement of RoHS directive (\*). In all cases the devices have Pb-free terminals. All devices with these suffixes meet the requirements of the RoHS directive.

This status is based on CEL’s understanding of the EU Directives and knowledge of the materials that go into its products as of the date of disclosure of this information.

Restricted Substance per RoHS	Concentration Limit per RoHS (values are not yet fixed)	Concentration contained in CEL devices	
		-A	-AZ
Lead (Pb)	< 1000 PPM	Not Detected	(*)
Mercury	< 1000 PPM	Not Detected	
Cadmium	< 100 PPM	Not Detected	
Hexavalent Chromium	< 1000 PPM	Not Detected	
PBB	< 1000 PPM	Not Detected	
PBDE	< 1000 PPM	Not Detected	

If you should have any additional questions regarding our devices and compliance to environmental standards, please do not hesitate to contact your local representative.

**Important Information and Disclaimer:** Information provided by CEL on its website or in other communications concerning the substance content of its products represents knowledge and belief as of the date that it is provided. CEL bases its knowledge and belief on information provided by third parties and makes no representation or warranty as to the accuracy of such information. Efforts are underway to better integrate information from third parties. CEL has taken and continues to take reasonable steps to provide representative and accurate information but may not have conducted destructive testing or chemical analysis on incoming materials and chemicals. CEL and CEL suppliers consider certain information to be proprietary, and thus CAS numbers and other limited information may not be available for release.

In no event shall CEL’s liability arising out of such information exceed the total purchase price of the CEL part(s) at issue sold by CEL to customer on an annual basis.

See CEL Terms and Conditions for additional clarification of warranties and liability.