



Chipsmall Limited consists of a professional team with an average of over 10 year of expertise in the distribution of electronic components. Based in Hongkong, we have already established firm and mutual-benefit business relationships with customers from,Europe,America and south Asia,supplying obsolete and hard-to-find components to meet their specific needs.

With the principle of “Quality Parts,Customers Priority,Honest Operation,and Considerate Service”,our business mainly focus on the distribution of electronic components. Line cards we deal with include Microchip,ALPS,ROHM,Xilinx,Pulse,ON,Everlight and Freescale. Main products comprise IC,Modules,Potentiometer,IC Socket,Relay,Connector.Our parts cover such applications as commercial,industrial, and automotives areas.

We are looking forward to setting up business relationship with you and hope to provide you with the best service and solution. Let us make a better world for our industry!



Contact us

Tel: +86-755-8981 8866 Fax: +86-755-8427 6832

Email & Skype: info@chipsmall.com Web: www.chipsmall.com

Address: A1208, Overseas Decoration Building, #122 Zhenhua RD., Futian, Shenzhen, China



DESCRIPTION

This UPS3100e3 in the Powermite3[®] package is a high efficiency Schottky rectifier that is also RoHS compliant offering high current/power capabilities previously found only in much larger packages. They are ideal for SMD applications that operate at high frequencies. In addition to its size advantages, the Powermite3[®] package includes a full metallic bottom that eliminates the possibility of solder flux entrapment during assembly and a unique locking tab act as an efficient heat path to the heat-sink mounting. Its innovative design makes this device ideal for use with automatic insertion equipment.

IMPORTANT: For the most current data, consult MICROSEMI's website: <http://www.microsemi.com>


KEY FEATURES

- Very low thermal resistance package
- RoHS Compliant with e3 suffix part number
- Guard-ring-die construction for transient protection
- Efficient heat path with Integral locking bottom metal tab
- Low forward voltage
- Full metallic bottom eliminates flux entrapment
- Compatible with automatic insertion
- Low profile-maximum height of 1mm

ABSOLUTE MAXIMUM RATINGS AT 25° C (UNLESS OTHERWISE SPECIFIED)

Rating	Symbol	Value	Unit
Peak Repetitive Reverse Voltage Working Peak Reverse Voltage DC Blocking Voltage	V_{RRM} V_{RWM} V_R	100	V
RMS Reverse Voltage	$V_{R(RMS)}$	70	V
Average Rectified Output Current	I_o	3	A
Non-Repetitive Peak Forward Surge Current 8.3ms Single half sine wave Superimposed on Rated Load@ $T_c = 90^\circ C$	I_{FSM}	50	A
Storage Temperature	T_{STG}	-55 to +150	°C
Junction Temperature	T_J	-55 to +125	°C

APPLICATIONS/BENEFITS

- Switching and Regulating Power Supplies.
- Silicon Schottky (hot carrier) rectifier for minimal reverse voltage recovery
- Elimination of reverse-recovery oscillations to reduce need for EMI filtering
- Charge Pump Circuits
- Reduces reverse recovery loss with low I_{RM}
- Small foot print 
190 X 260 mils (1:1 Actual size)
See mounting pad details on pg 3

MECHANICAL & PACKAGING

- CASE: Void-free transfer molded thermosetting epoxy compound meeting UL94V-0
- FINISH: Annealed matte-Tin plating over copper and readily solderable per MIL-STD-750 method 2026 (consult factory for Tin-Lead plating)
- POLARITY: See figure (left)
- MARKING: S3100•
- WEIGHT: 0.072 gram (approx.)
- Package dimension on last page
- Tape & Reel option: 16 mm tape per Standard EIA-481-B, 5000 on 13" reel

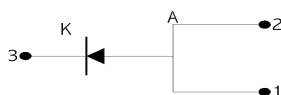
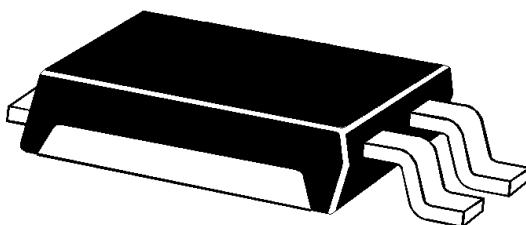
THERMAL CHARACTERISTICS

Thermal Resistance

Junction-to-Case (bottom)	$R_{\theta JC}$	2.5	°C/ Watt
Junction to Ambient (1)	$R_{\theta JA}$	65	°C/ Watt

(1) When mounted on FR-4 PC board using 2 oz copper with recommended minimum foot print

Powermite 3™



ELECTRICAL PARAMETERS @25°C (unless otherwise specified)

Parameter	Symbol	Conditions	Min	Typ.	Max	Units
Forward Voltage (Note 1)	V_F	$I_F = 3\text{ A}, T_J = 25^\circ\text{C}$ $I_F = 3\text{ A}, T_J = 100^\circ\text{C}$ $I_F = 6\text{ A}, T_J = 25^\circ\text{C}$ $I_F = 6\text{ A}, T_J = 100^\circ\text{C}$		0.72 0.60 0.79 0.68	0.76 0.64 0.83 0.72	V
Reverse Break Down Voltage (Note 1)	V_{BR}	$I_R = 0.2\text{ mA}$	100			V
Reverse Current (Note1)	I_R	$V_R = 100\text{V}, T_J = 25^\circ\text{C}$ $V_R = 100\text{V}, T_J = 100^\circ\text{C}$		1.5 0.5	200 20	μA mA
Capacitance	C_T	$V_R = 4\text{ V}; f = 1\text{ MHz}$		85		pF

Note: 1 Short duration test pulse used to minimize self – heating effect.

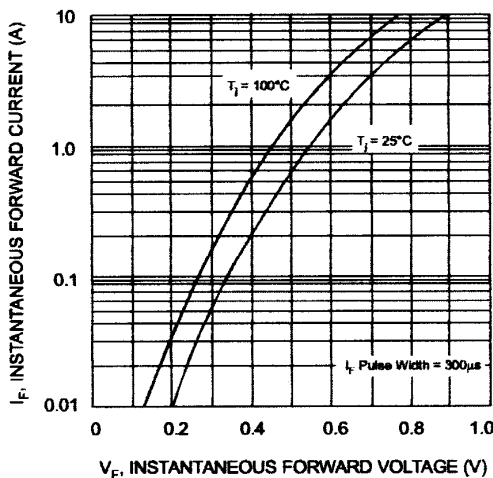


Fig. 1 Typical Forward Characteristics

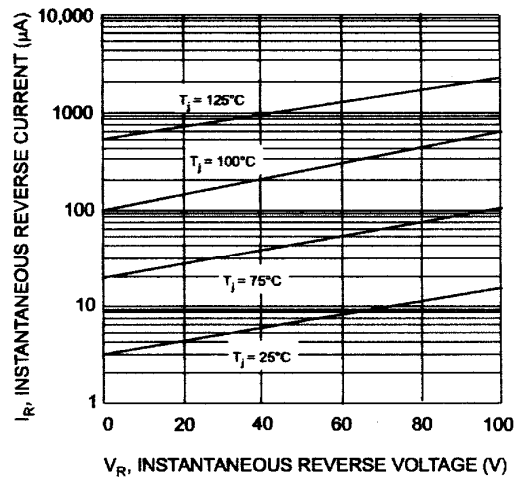


Fig. 2 Typical Reverse Characteristics

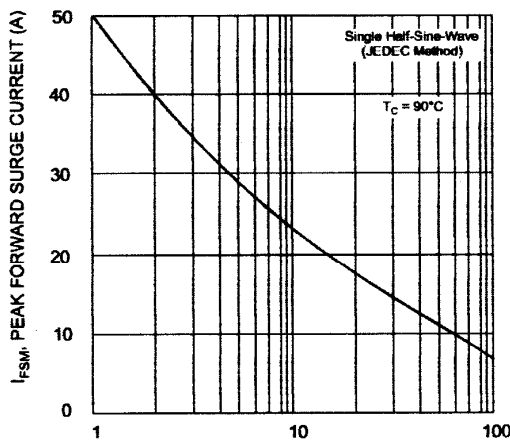


Fig. 3 Max Non-Repetitive Peak Fwd Surge Current

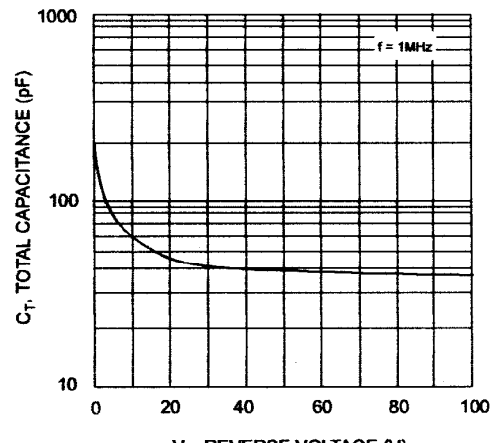
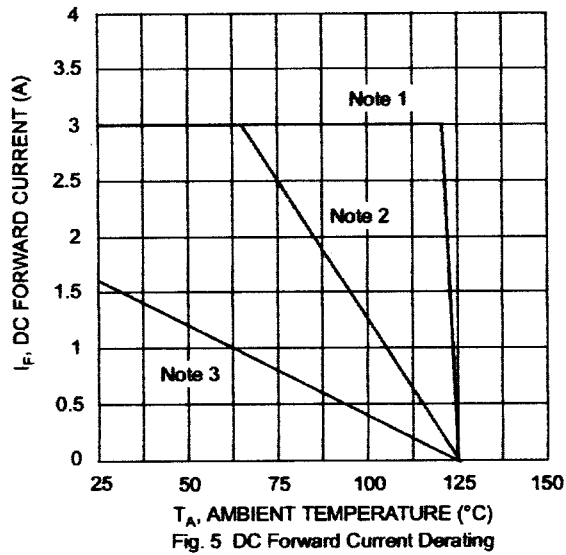
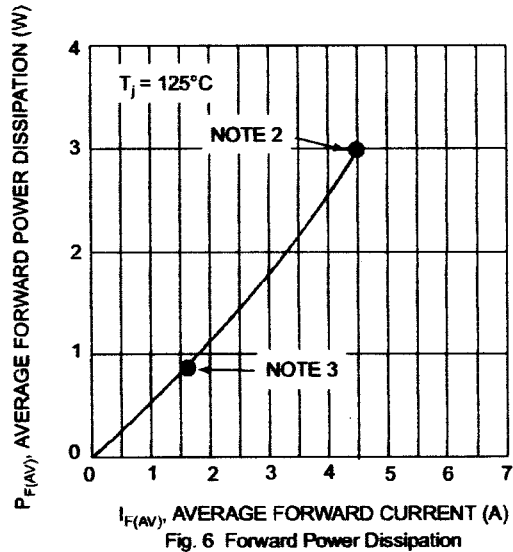
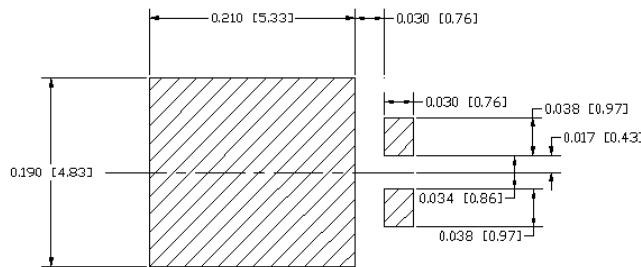


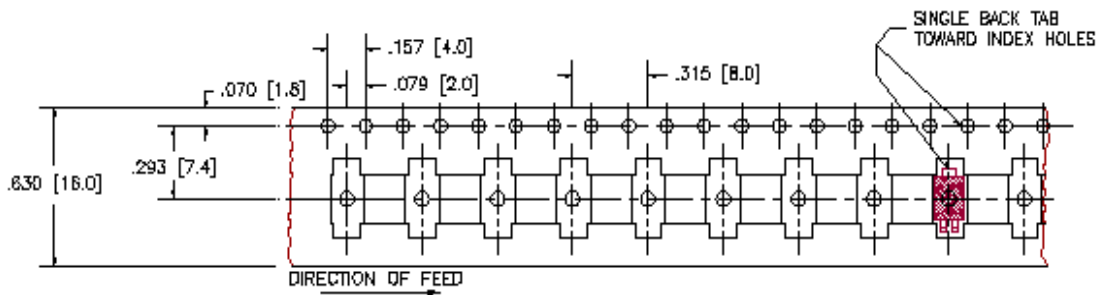
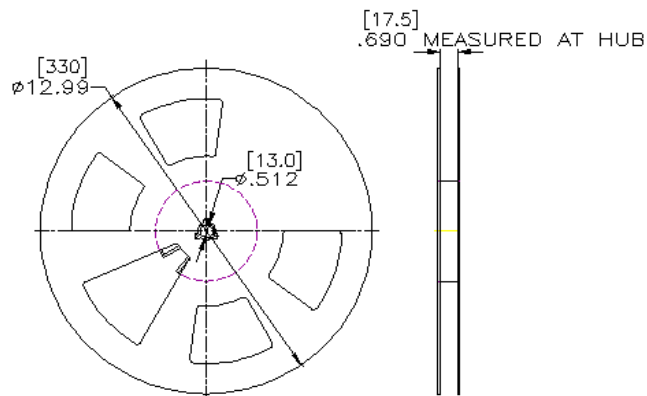
Fig. 4 Typical Capacitance vs. Reverse Voltage

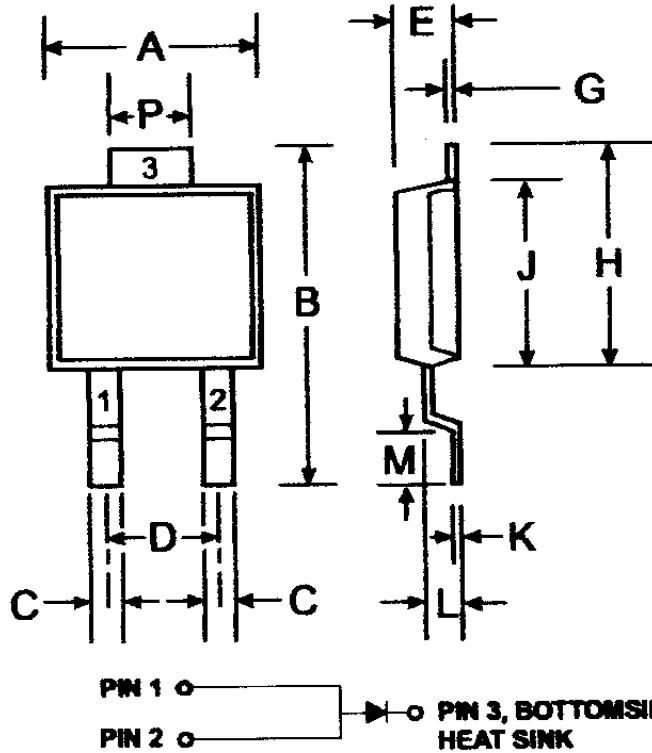

Fig. 5 DC Forward Current Derating

Fig. 6 Forward Power Dissipation

- Notes:
1. T_A = T_{SOLDERING POINT}, R_{ΘJS} = 2.5C/W, R_{ΘSA} = 0°C/W.
 2. Device mounted on GETEK substrate, 2" x 2", 2 oz. copper, double-sided, cathode pad dimensions 0.75" x 1.0", anode pad dimensions 0.25" x 1.0". R_{ΘJA} in range of 20-35°C/W.
 3. Device mounted on FRA-4 substrate, 2" x 2", 2 oz. copper, single-sided, pad layout R_{ΘJA} in range of 65°C/W. See mounting pad below.

MOUNTING PAD DIMENSIONS


Mounting Pad Dimensions: inches [mm]

TAPE & REEL

13 INCH REEL

MECHANICAL

PACKAGE DIMENSIONS


Note: Pins 1 & 2 must be electrically connected at the printed circuit board.

POWERMITE®3		
Dim	Min	Max
A	4.03	4.09
B	6.40	6.61
C	.889 NOM	
D	1.83 NOM	
E	1.10	1.14
G	.178 NOM	
H	5.01	5.17
J	4.37	4.43
K	.178 NOM	
L	.71	.77
M	.36	.46
P	1.73	1.83
All Dimensions in mm		