



Chipsmall Limited consists of a professional team with an average of over 10 year of expertise in the distribution of electronic components. Based in Hongkong, we have already established firm and mutual-benefit business relationships with customers from,Europe,America and south Asia,supplying obsolete and hard-to-find components to meet their specific needs.

With the principle of “Quality Parts,Customers Priority,Honest Operation,and Considerate Service”,our business mainly focus on the distribution of electronic components. Line cards we deal with include Microchip,ALPS,ROHM,Xilinx,Pulse,ON,Everlight and Freescale. Main products comprise IC,Modules,Potentiometer,IC Socket,Relay,Connector.Our parts cover such applications as commercial,industrial, and automotives areas.

We are looking forward to setting up business relationship with you and hope to provide you with the best service and solution. Let us make a better world for our industry!



Contact us

Tel: +86-755-8981 8866 Fax: +86-755-8427 6832

Email & Skype: info@chipsmall.com Web: www.chipsmall.com

Address: A1208, Overseas Decoration Building, #122 Zhenhua RD., Futian, Shenzhen, China



UltraStable 600

SCHAEVITZ
SENSORS

High Stability Stainless Steel Pressure Transducer

The **UltraStable 600** from Schaevitz Sensors, a division of Measurement Specialties, incorporates an ultra-rugged IP 67 rated housing. All wetted parts are constructed of 316L stainless steel, providing media isolation and no internal "O" rings.

The UltraStable 600 also offers a wide selection of standard pressure ranges and electrical outputs. The unit's high stability rating is provided by IC Sensors' solid state UltraStable technology, which provides stability over a wide temperature range. The modular design is adaptable to an infinite number of port variations, and standard outputs include .5V to 4.5V ratiometric, 0V to 5V, 1V to 5V, 0V to 10V, regulated and 4 to 20mA current loop.

The UltraStable's small size vs. high performance enables the miniaturization of high accuracy pressure and vacuum systems. The unit's new low-pressure ranges add sensitivity that has previously been unavailable in transducers of this size. The competitive price, coupled with its high accuracy, may make the UltraStable 600 the best choice for your application.

Field replacement can easily be performed without sacrificing accuracy due to the very small total error band of .75% max.



0.75%
TEB

Features

- ◆ 0.75% TEB (Total Error Band) with .5% TEB available as an option
- ◆ 0.1% Accuracy - typically
- ◆ -50 to 125° C Operating Temperature
- ◆ 100% stainless steel isolation. Small size
- ◆ Wide variety of pressure ranges and electrical outputs
- ◆ Broad assortment of standard connectors and ports
- ◆ UltraStable sensing technology
- ◆ CE versions available
- ◆ Custom versions available
- ◆ Ranges starting from 15 psi FS
- ◆ High field Interchangeability

Applications

- ◆ Refrigeration and HVAC controls
- ◆ Process control
- ◆ Marine systems
- ◆ Tank level
- ◆ Industrial machinery
- ◆ Calibration equipment

A Division of



MEASUREMENT
SPECIALTIES

Static Performance Specifications

Units	Amplified Ratiometric 0.5 - 4.5 V out			Amplified 0-5 V, 1-5 V, 0-10 V out			Amplified 4 to 20 mA , two wire			Notes
	Min.	Typ.	Max.	Min.	Typ.	Max.	Min.	Typ.	Max.	
Supply voltage V	4.75	5	5.25	8		30	10		30	1
Supply Current mA	2.5	3	3.5	2.5	3	3.5	20			
Min load impedance	100 K ohm			100 K ohm						
Max load impedance							RL=50* (Vsupply-10)			
Accuracy %FS	-0.1		+0.1	-0.1		+0.1	-0.1		+0.1	3, 4
Offset %FS	-0.5		+0.5	-0.5		+0.5	-0.5		+0.5	2
Span %FS	-0.5		+0.5	-0.5		+0.5	-0.5		+0.5	2
Long Term stability %FS/year		0.1			0.1			0.1		
Response time ms	1.0			1.0			1.0			
Isolation Resistance M ohm	50			50			50			5

Notes:

- 1) Supply voltage must be 12 V for units with 10 V out.
- 2) Room temperature calibration.
- 3) Combined BFSL, hysteresis and repeatability (Per ISA S37.2) .25% for 1Kpsi and above
- 4) Over temp range -20 to +85° C
- 5) @ 50 V DC

Environmental Performance

Specification	Min.	Typ.	Max.	Notes
Total error band -20 to +85° C, -7 to 185° F	-0.75 %FS	0.50 %FS	+0.75 %FS	1, 3, 4
Operating temperature range	-50°C -58°F		125°C 257° F	2,3
Storage temperature range	-50°C -58°F		125°C 257° F	2

Notes:

- 1) With reference to 25 ° C, (77 ° F)
- 2) Standard 105° C max. for cable version
- 3) Lower ranges available - consult factory
- 4) 0.5% max availability - consult factory

Schaevitz® Sensors

Division of Measurement Specialties
 1000 Lucas Way
 Hampton, VA 22666
 1-800-745-8008
 Phone: 757-766-1500

Mechanical Specifications

Specification	Value	Notes
Proof pressure	3x rated pressure	
Burst pressure	4x rated pressure or 20k psi	2
Vibration	20 G's rms @2kHz	
Shock	100G 11ms	
Pressure cycles	1 million cycles 0 to full scale	
Media compatibility	All materials compatible with 316 stainless steel	1
Environmental protection	IP 67 (Cable version)	

1) Other materials available - consult factory

2) Which ever is less, 10X burst available on some pressure ranges (consult factory)

Ordering Information

US6 US6	Output X	Electrical Connection X -	Specials XXXXX	Port type X	Pressure range XXXX	Pressure unit X
Output	Connection	Specials	Port	Pressure Range		Pressure Units
3=.5 to 4.5V ratio (1)	1=Cable 2 feet	For Non-Standard	2= 1/4-19 BSP	PSI Ranges	Bar Ranges	A = absolute
4= 1 to 5V	4 = Integral Packard	the standard num-	4= 7/16-20 UNF		001B = 0 to 1 Bar	G = gauge
6= 0 to 5V	5 = PTIH-10-6P	ber of "00000"	5=1/4-18 NPT	015P = 0 to 15 psi	002B = 0 to 2 Bar	
7= 0 to 10V	(Bendix style)	changes to a higher	6= 1/8-27 NPT	030P = 0 to 30 psi	005B = 0 to 5 Bar	
8=4-20 mA	6 = GSSR 300 (9.4	value .i.e 1XXXX		050P = 0 to 50psi	007B = 0 to 7 Bar	
X=Special output	Hirshman)	Special numbers	X= special port	100P =0 to 100psi	010B = 0 to 10 Bar	
	8 = PTIH-08-4P	starting with a "C"		300P = 0 to 300psi	020B = 0 to 20 Bar	
	(Bendix Style)	are CE rated		500P - 0 to 500psi	035B = 0 to 35 Bar	
	x = Special			01KP = 0 to 1Kpsi	070B = 0 to 70 Bar	
	Connection			03KP = 0 to 3Kpsi	200B = 0 to 200 Bar	
				05KP = 0 to 5Kpsi	350B = 0 to 350 Bar	

Example:

US664-000005-100PG is an UltraStable 600 with 0 to 5V out, Packard Connector, nothing special, 1/4 NPT pressure port and 100 psi gage.

US681-C00002- 005PG is an UltraStable 600 with 4-20 mA, 2-wire, output, 2 feet of cable, CE certified, 1/4 BSP male pressure port and 5 psi gage.

1) For ratiometric output, span changes with input voltage (see supply voltage specifications)

Schaevitz® Sensors

Division of Measurement Specialties

1000 Lucas Way
Hampton, VA 22666

1-800-745-8008

Phone: 757-766-1500

UltraStable 600

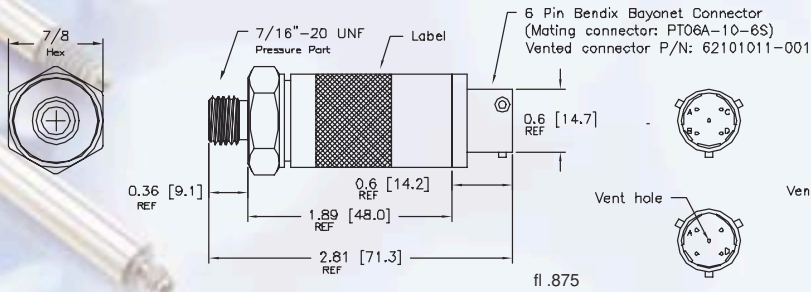

CONNECTIONS

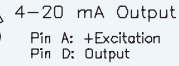
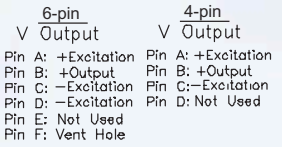

Vent through removed Pin F hole (under 1000 psi) Add 0.4" for CE EMI/RFI protection.

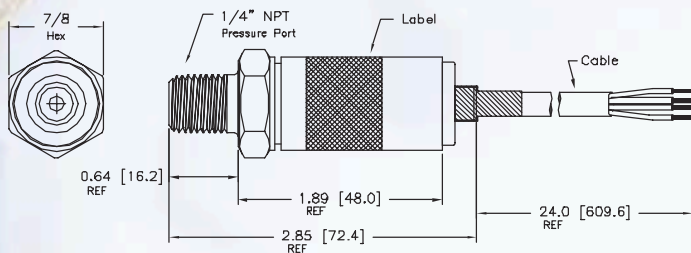

CONNECTIONS

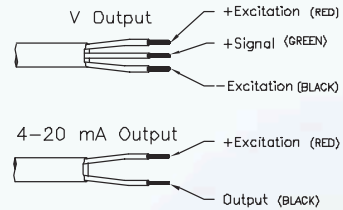

Vent through cable (under 1000 psi). Add 0.4" for CE EMI/RFI protection, max operating temperature for cable is 100°C.

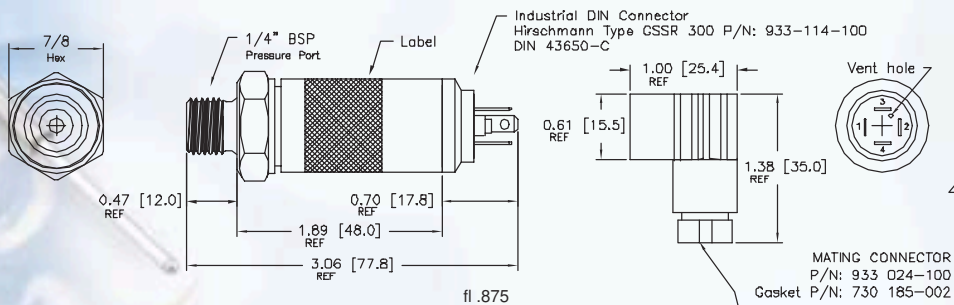

CONNECTIONS

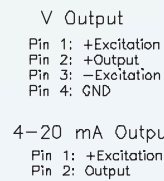

MATING CONNECTOR
P/N: 933 024-100
Gasket P/N: 730 185-002

Vent through hole in connector (under 1000 psi) Add 0.4" for CE EMI/RFI protection.

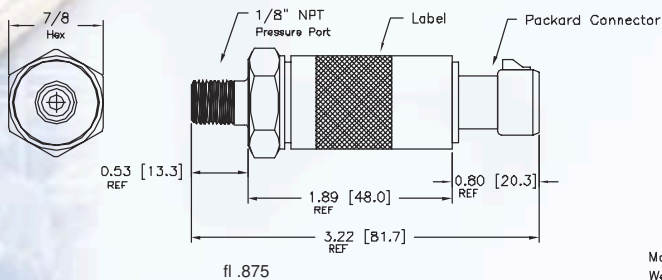

CONNECTIONS

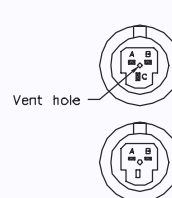

Mating connector: Housing p/n: 12078090 Pin p/n: 12103881-L
Web Site for mating connector: www.powerandsignal.com

Vent through hole in connector (under 1000 psi) Add 0.4" for CE EMI/RFI protection.
Note: Mating connector is available with 3 ft of cable PN (2001140).

Schaevitz® Sensors

Division of Measurement Specialties
1000 Lucas Way
Hampton, VA 22666
1-800-745-8008
Phone: 757-766-1500