



Chipsmall Limited consists of a professional team with an average of over 10 year of expertise in the distribution of electronic components. Based in Hongkong, we have already established firm and mutual-benefit business relationships with customers from,Europe,America and south Asia,supplying obsolete and hard-to-find components to meet their specific needs.

With the principle of “Quality Parts,Customers Priority,Honest Operation,and Considerate Service”,our business mainly focus on the distribution of electronic components. Line cards we deal with include Microchip,ALPS,ROHM,Xilinx,Pulse,ON,Everlight and Freescale. Main products comprise IC,Modules,Potentiometer,IC Socket,Relay,Connector.Our parts cover such applications as commercial,industrial, and automotives areas.

We are looking forward to setting up business relationship with you and hope to provide you with the best service and solution. Let us make a better world for our industry!



## Contact us

Tel: +86-755-8981 8866 Fax: +86-755-8427 6832

Email & Skype: info@chipsmall.com Web: www.chipsmall.com

Address: A1208, Overseas Decoration Building, #122 Zhenhua RD., Futian, Shenzhen, China



**Amphenol**  
Socapex

■ **FIELD BUS**  
solutions



## **USB-A Field**

*Amphenol Rugged USB-A plastic & neoprene solutions with Self Closing Cap*

[www.rjfield.com](http://www.rjfield.com) / [www.usbfield.com](http://www.usbfield.com)

Amphenol USB-A Field - Plastic & Neoprene versions are rugged USB interconnect solutions fitted to be used in any industrial harsh environment. The Self Closing Cap enclosure enables to protect the USB-A Field receptacle from dust and fluids when the plug or the USB Memory key are unmated.

## ■ Main characteristics

### • Sealing Level :

Matted condition with plug or Rugged USB Memory Key : IP67  
 Receptacle with Self Closing Cap alone : IP54

- Mating cycles: 500
- Push / Pull mating
- Neoprene shells for plug & USB Keys
- Data Transmission : USB Specification 2.0
- Data Rate: Up to 480 Mb/s for High Speed USB
- Temperature Range: - 40°C / +85°C
- RoHS compliant

## ■ Applications

- Access point
- Telecom Equipments
- Video Control
- Robotics
- Industrial Process Control
- CNC Machines
- Special Machines

## ■ Memory Key with soft neoprene shell

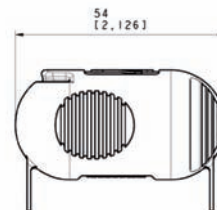
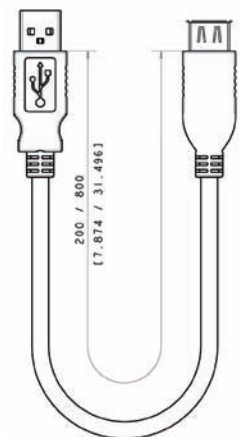
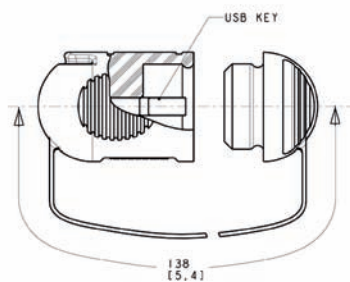
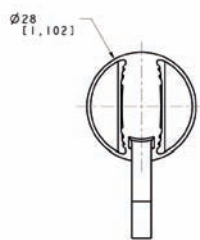

REFERENCE PART NUMBER	CAPACITE (Mo) CAPACITY (Mb)
USBAPKEY 1024	1024
USBAPKEY 2048	2048
USBAPKEY 4096	4096
USBAPKEY 8192	8192

IP 67 when matted  
 on receptacle or with  
 neoprene protective cap

# OVERALL DIMENSIONS & P/N

Preliminary Datasheet

## ■ Plug with soft neoprene shell



Part Number :  
**USBAP 6 xxxA**  
WITH USB-A PLUG

Part Number :  
**USBAP 6 xxx**  
Open

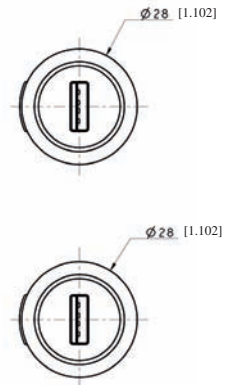
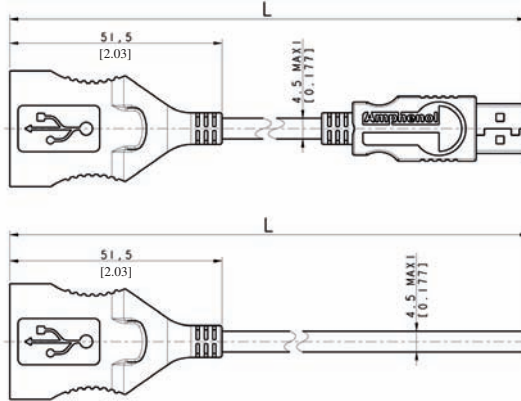

REFERENCE PART NUMBER	TYPE D'EXTREMITÉ EXTREMITY TYPE Ouverte ou USB-A Open or USB-A	L <sup>+0</sup> / <sub>-0.5</sub> cm Mètres Meters	L <sup>+0</sup> / <sub>-0.164</sub> ft Pieds Feet
USBAP6 05 OPEN	OUVERTE OPEN	0.5	1.64
USBAP6 05A	USB-A	0.5	1.64
USBAP6 10 OPEN	OUVERTE OPEN	1.0	3.28
USBAP6 10A	USB-A	1.0	3.28
USBAP6 15 OPEN	OUVERTE OPEN	1.5	4.92
USBAP6 15A	USB-A	1.5	4.92
USBAP6 20 OPEN	OUVERTE OPEN	2.0	6.56
USBAP6 20A	USB-A	2.0	6.56

IP 67 when matted on receptacle

## ■ Square Flange Receptacle - IP54 when alone

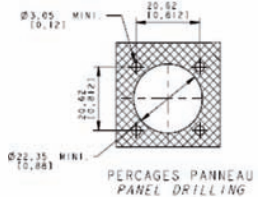
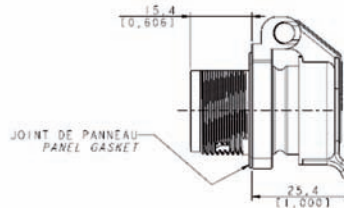
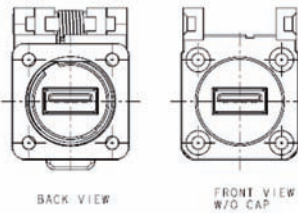
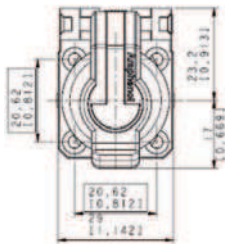

Part Number : **USBAPSCC 21**

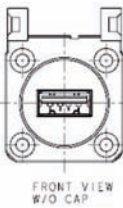
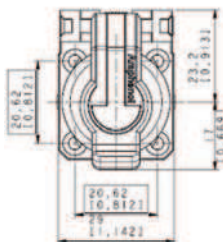

Longueurs standards L : 0.2M [0.66 ft.]  
Standard lengths L : 0.3M [0.98 ft.]  
0.5M [1.65 ft.]  
1.0M [3.28 ft.]

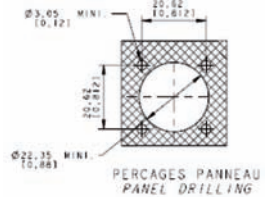
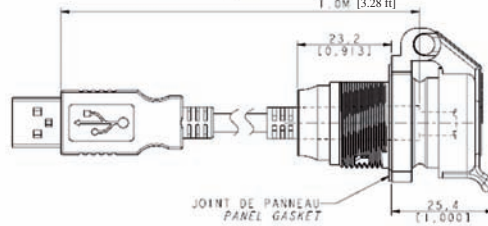

Part Numbers :

**USBAPSCC 22 02A** (0.2 m [0.66 ft.] cordset length) / **USBAPSCC 22 03A** (0.3 m [0.98 ft.] cordset length)  
**USBAPSCC 22 05A** (0.5 m [1.65 ft.] cordset length) / **USBAPSCC 22 10A** (1 m [3.28 ft.] cordset length)

# OVERALL DIMENSIONS & P/N

Preliminary Datasheet

## ■ Jam Nut Receptacle - IP54 when alone

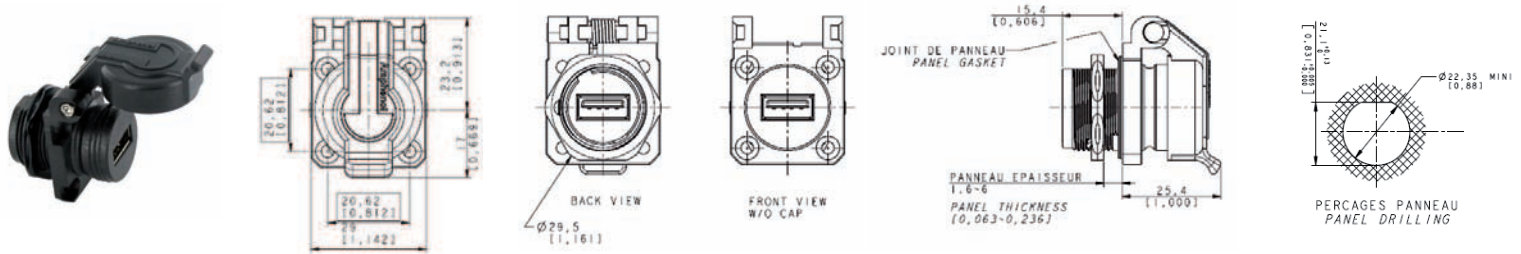

Part Number : **USBAPSCC 71**

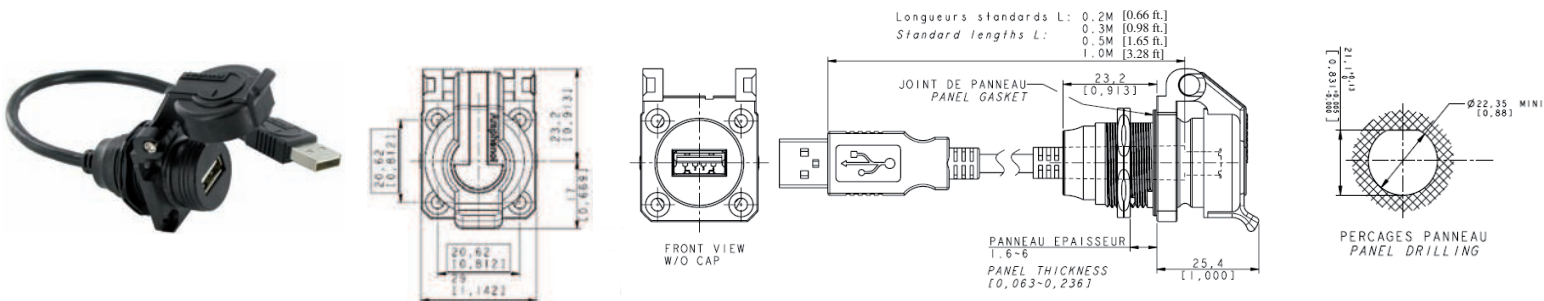

Part Numbers :

**USBAPSCC 72 02A** (0.2 m [0.66 ft.] cordset length) / **USBAPSCC 72 03A** (0.3 m [0.98 ft.] cordset length)  
**USBAPSCC 72 05A** (0.5 m [1.65 ft.] cordset length) / **USBAPSCC 72 10A** (1 m [3.28 ft.] cordset length)

## ■ USB plastic – IP67 cap (for square flange receptacle only)

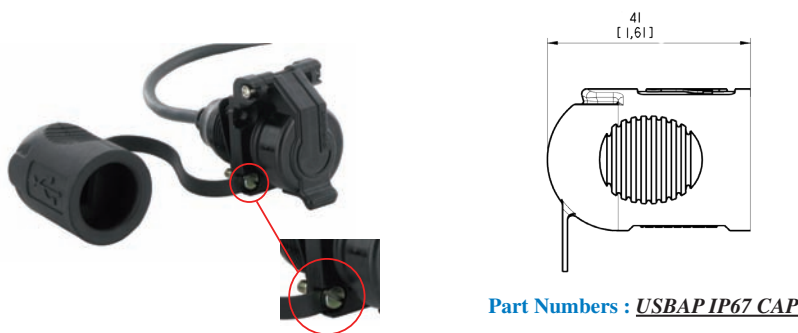

Cap lanyard fixed by a screw (for square flange receptacle only)

How to unplug :



Locking Shape :

Push-up the self-closing cap before removing the USBKey, Plug or IP67 protective cap from the receptacle

## Amphenol Socapex

948, Promenade de l'Arve - BP 29  
 74311 Thyez cedex - France  
 Phone : +33 450 89 28 00  
 Fax : +33 450 96 29 75

**Amphenol**  
**Socapex**