



Chipsmall Limited consists of a professional team with an average of over 10 year of expertise in the distribution of electronic components. Based in Hongkong, we have already established firm and mutual-benefit business relationships with customers from,Europe,America and south Asia,supplying obsolete and hard-to-find components to meet their specific needs.

With the principle of “Quality Parts,Customers Priority,Honest Operation,and Considerate Service”,our business mainly focus on the distribution of electronic components. Line cards we deal with include Microchip,ALPS,ROHM,Xilinx,Pulse,ON,Everlight and Freescale. Main products comprise IC,Modules,Potentiometer,IC Socket,Relay,Connector.Our parts cover such applications as commercial,industrial, and automotives areas.

We are looking forward to setting up business relationship with you and hope to provide you with the best service and solution. Let us make a better world for our industry!



Contact us

Tel: +86-755-8981 8866 Fax: +86-755-8427 6832

Email & Skype: info@chipsmall.com Web: www.chipsmall.com

Address: A1208, Overseas Decoration Building, #122 Zhenhua RD., Futian, Shenzhen, China



RoHS compliant

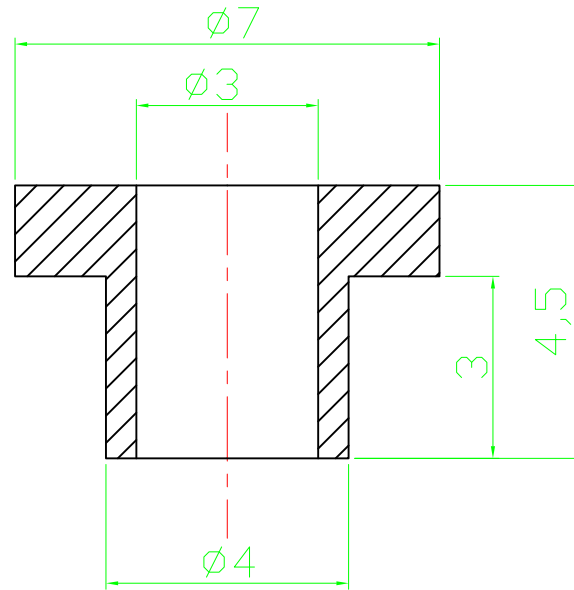

Notes
 Material:SR25
 Dielectric strength: 380kV/cm
 Heat resistance:215°C
 Tensile strength: 80N/mm

Scale	1:1					Date	Name	Customer-No.
TOLERANCE					Drawn	20.08.2009	Dean	
X.	$\pm X$				Approved	10.03.2010	Andy	ASSMANN WSW-No.
X.X	$\pm X$							V5815
X.XX	$\pm X$							Drawing-No.
DIM	TOL	②	Modify drawing layout	10.03.2010	Dean		ASS 0900 HS	rev02
X.°	$\pm X^\circ$	①	Drawn	20.08.2009	Dean		Replace	Sheet
X.X°	$\pm X^\circ$							
Angle	TOL	Id.	Modification	Date	Name			