



Chipsmall Limited consists of a professional team with an average of over 10 year of expertise in the distribution of electronic components. Based in Hongkong, we have already established firm and mutual-benefit business relationships with customers from,Europe,America and south Asia,supplying obsolete and hard-to-find components to meet their specific needs.

With the principle of "Quality Parts,Customers Priority,Honest Operation,and Considerate Service",our business mainly focus on the distribution of electronic components. Line cards we deal with include Microchip,ALPS,ROHM,Xilinx,Pulse,ON,Everlight and Freescale. Main products comprise IC,Modules,Potentiometer,IC Socket,Relay,Connector.Our parts cover such applications as commercial,industrial, and automotives areas.

We are looking forward to setting up business relationship with you and hope to provide you with the best service and solution. Let us make a better world for our industry!



Contact us

Tel: +86-755-8981 8866 Fax: +86-755-8427 6832

Email & Skype: info@chipsmall.com Web: www.chipsmall.com

Address: A1208, Overseas Decoration Building, #122 Zhenhua RD., Futian, Shenzhen, China



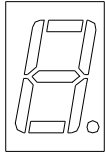

Product :
0.56 " SINGLE DIGIT DISPLAY

Part Number :
VAOS-C561S9-BW/43
VAOS-A561S9-BW/43

Description

Chip Material-S: AlGaAs/GaAs.
Emitted Color: Super Bright Red.
Black Face & White Segment.

VAOS-C561S9-BW/43
Common Cathode.

VAOS-A561S9-BW/43
Common Anode.

Absolute Maximum Ratings at Ta=25°C

Parameter	Symbol	Super Bright Red	Unit
Power dissipation per dice	PAD	75	mW
Derating Liner from 25°C per dice	-	0.42	mA°C
Continuous forward current per dice	IAF	30	mA
Peak current per dice (duty cycle 1/10, 1kHz)	IPF	150	mA
Reverse voltage per dice	VR	5	V
Operating temperature	Topr	-25 to +85	°C
Storage temperature	Tstg	-25 to +85	°C
Solder temperature 1/16 inch below seating plane for 5 seconds at 260°C			

Electrical / Optical Characteristics and Curves at Ta=25°C

Parameter	Symbol	Test Condition	Min.	Typ.	Max.	Unit
Forward Voltage per segment	VF	IF=20 mA		1.8	2.5	V
Luminous intensity per segment	IV	IF=20 mA		10		mcd.
Peak emission wavelength	λd	IF=20 mA		660		nm
Spectrum radiation bandwidth	$\Delta \lambda$	IF=20 mA		20		Deg.
Reverse Current	IR	VR=5 V			100	μA

* Tolerance : $\pm 20\%$.

Package Dimension & Internal Circuit

- * 0.56 inch (14.2mm) Digit height.
- * Case mold type.
- * Excellent character appearance.
- * Wide viewing angle.

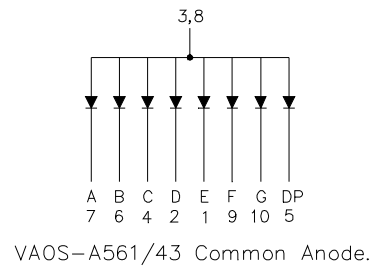
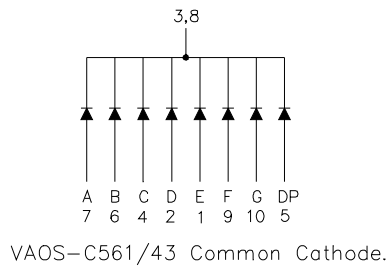
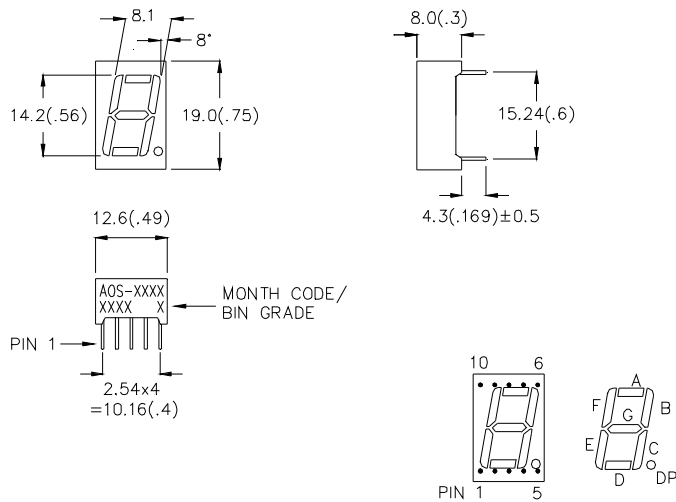

NOTE:

1. All pins are $\varnothing 0.51(.02)$.
2. Dimension in millimeter (inch), and tolerance is $\pm 0.30 (.01)$ unless otherwise noted.

VER_A-08-10-P43



RED

Typical Electro-optical Characteristic Curves (25°C Free Air Temperature Unless Otherwise Specified)

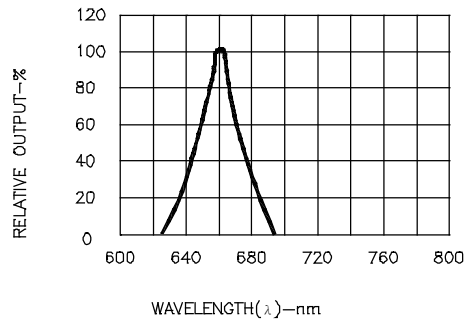

Fig.1 SPECTRAL RESPONSE

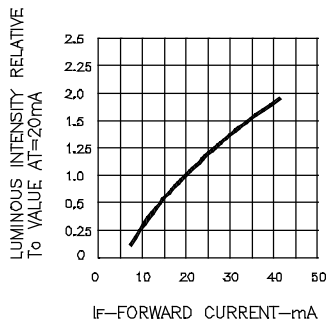

Fig.2 RELATIVE LUMINOUS INTENSITY VS. FORWARD CURRENT

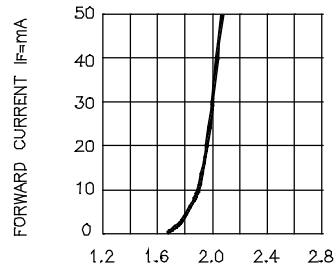

Fig.3 FORWARD CURRENT VS FORWARD VOLTAGE

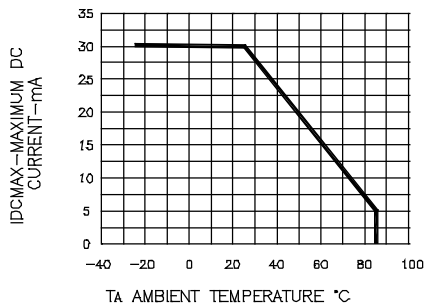

Fig.4 MAXIMUM ALLOWABLE DC CURRENT PER SEGMENT VS. A FUNCTION OF AMBIENT TEMPERATURE

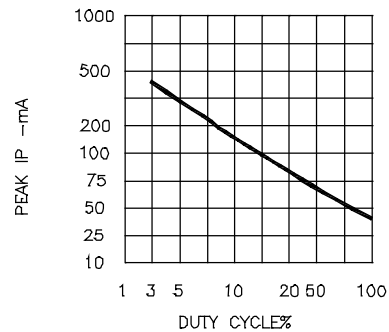

Fig.5 MAX PEAK CURRENT VS. DUTY CYCLE % (REFRESH RATE f=1KHz)