



Chipsmall Limited consists of a professional team with an average of over 10 year of expertise in the distribution of electronic components. Based in Hongkong, we have already established firm and mutual-benefit business relationships with customers from,Europe,America and south Asia,supplying obsolete and hard-to-find components to meet their specific needs.

With the principle of “Quality Parts,Customers Priority,Honest Operation,and Considerate Service”,our business mainly focus on the distribution of electronic components. Line cards we deal with include Microchip,ALPS,ROHM,Xilinx,Pulse,ON,Everlight and Freescale. Main products comprise IC,Modules,Potentiometer,IC Socket,Relay,Connector.Our parts cover such applications as commercial,industrial, and automotives areas.

We are looking forward to setting up business relationship with you and hope to provide you with the best service and solution. Let us make a better world for our industry!



Contact us

Tel: +86-755-8981 8866 Fax: +86-755-8427 6832

Email & Skype: info@chipsmall.com Web: www.chipsmall.com

Address: A1208, Overseas Decoration Building, #122 Zhenhua RD., Futian, Shenzhen, China



Fully Integrated Proximity and Ambient Light Sensor with Infrared Emitter and I²C Interface

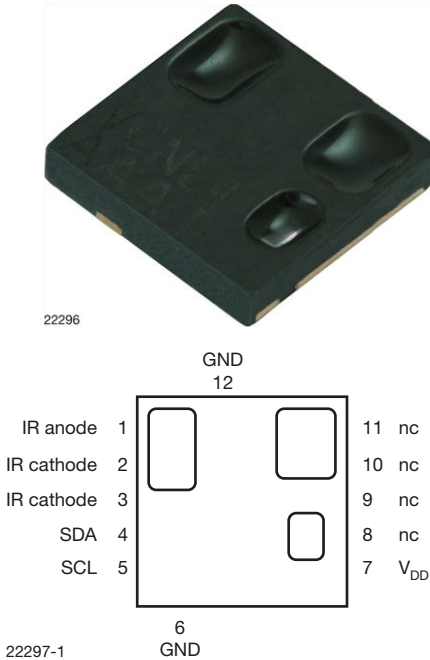

FEATURES

- Package type: surface mount
- Dimensions (L x W x H in mm): 3.95 x 3.95 x 0.75
- Integrated module with ambient light sensor, proximity sensor and signal conditioning IC
- Supply voltage range V_{DD} : 2.5 V to 3.6 V
- Supply voltage range IR anode: 2.5 V to 5 V
- Communication via I²C interface
- I²C Bus H-level range: 1.7 V to 5 V
- Floor life: 168 h, MSL 3, acc. J-STD-020
- Low stand by current consumption: 1.5 μ A
- Material categorization: For definitions of compliance please see www.vishay.com/doc?99912



PROXIMITY FUNCTION

- Built in infrared LED and photo-pin-diode for proximity function
- 16 bit effective resolution for proximity detection range ensures excellent cross talk immunity
- Programmable LED drive current from 10 mA to 200 mA (in 10 mA steps)
- Excellent ambient light suppression by signal modulation
- Proximity distance up to 200 mm

AMBIENT LIGHT FUNCTION

- Built in ambient light photo-pin-diode with close to human eye sensitivity characteristic
- 16 bit dynamic range for ambient light detection from 0.25 lx to 16 klx
- 100 Hz and 120 Hz flicker noise rejection

DESCRIPTION

VCNL4000 is a fully integrated proximity and ambient light digital 16 bit resolution sensor in a miniature lead less package (LLP) for surface mounting. It includes a signal processing IC and supports an easy to use I²C bus communication interface.

APPLICATIONS

- Proximity sensor for mobile devices (e.g. smart phones, touch phones, PDA, GPS) for touch screen locking, power saving, etc.
- Integrated ambient light function for display/keypad contrast control and dimming of mobile devices
- Proximity/optical switch for consumer, computing and industrial devices and displays
- Dimming control for consumer, computing and industrial displays

PRODUCT SUMMARY

PART NUMBER	OPERATING RANGE (mm)	OPERATING VOLTAGE RANGE (V)	I ² C BUS VOLTAGE RANGE (V)	LED PULSE CURRENT ⁽¹⁾ (mA)	AMBIENT LIGHT RANGE (lx)	AMBIENT LIGHT RESOLUTION (lx)	OUTPUT CODE
VCNL4000	1 to 200	2.5 to 3.6	1.7 to 5	10 to 200	0.25 to 16 383	0.25	16 bit, I ² C

Note

⁽¹⁾ Adjustable through I²C interface

**ORDERING INFORMATION**

ORDERING CODE	PACKAGING	VOLUME ⁽¹⁾	REMARKS
VCNL4000-GS08	Tape and reel	MOQ: 1800 pcs	3.95 mm x 3.95 mm x 0.75 mm
VCNL4000-GS18		MOQ: 7000 pcs	
VCNL4000demokit (www.vishay.com/doc?833395)	-	MOQ: 1 pc	-

Note

(1) MOQ: minimum order quantity

ABSOLUTE MAXIMUM RATINGS ($T_{amb} = 25\text{ }^{\circ}\text{C}$, unless otherwise specified)

PARAMETER	TEST CONDITION	SYMBOL	MIN.	MAX.	UNIT
Supply voltage		V_{DD}	- 0.3	5.5	V
Operation temperature range		T_{amb}	- 25	+ 85	$^{\circ}\text{C}$
Storage temperature range		T_{stg}	- 40	+ 85	$^{\circ}\text{C}$
Total power dissipation	$T_{amb} \leq 25\text{ }^{\circ}\text{C}$	P_{tot}		50	mW
Junction temperature		T_j		100	$^{\circ}\text{C}$

BASIC CHARACTERISTICS ($T_{amb} = 25\text{ }^{\circ}\text{C}$, unless otherwise specified)

PARAMETER	TEST CONDITION	SYMBOL	MIN.	TYP.	MAX.	UNIT
Supply voltage V_{DD}			2.5		3.6	V
Supply voltage IR anode			2.5		5	V
I ² C Bus H-level range			1.7		5	V
Current consumption	Standby current, no IRED-operation			1.5	2	μA
Current consumption proximity mode incl. IRED (averaged)	2 measurements per second, IRED current 20 mA			4		μA
	250 measurements per second, IRED current 20 mA			500		μA
	2 measurements per second, IRED current 200 mA			31		μA
	250 measurements per second, IRED current 200 mA			3.8		mA
Current consumption ambient light mode	2 measurements per second averaging = 1			2.5		μA
	8 measurements per second averaging = 1			10		μA
	2 measurements per second averaging = 64			160		μA
	8 measurements per second averaging = 64			635		μA
Ambient light resolution	Digital resolution (LSB count)			0.25		lx
Ambient light output	$E_v = 100\text{ lx}$ averaging = 64			400		counts
I ² C clock rate range		f_{SCL}			3400	kHz

CIRCUIT BLOCK DIAGRAM

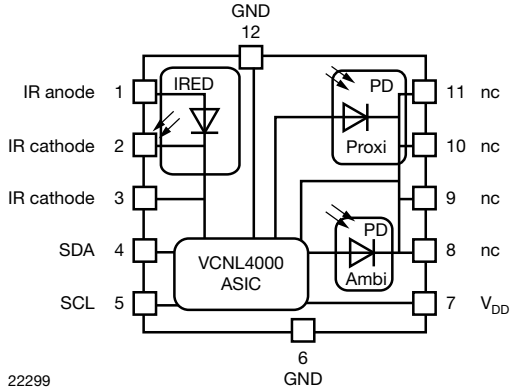

22299

TEST CIRCUIT

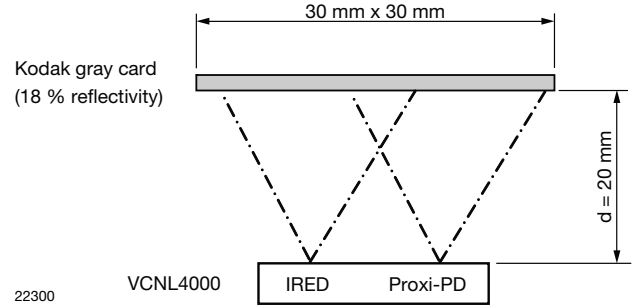

22300

Note

- nc must not be electrically connected
Pads 8 to 11 are only considered as solder pads

BASIC CHARACTERISTICS ($T_{amb} = 25\text{ }^{\circ}\text{C}$, unless otherwise specified)

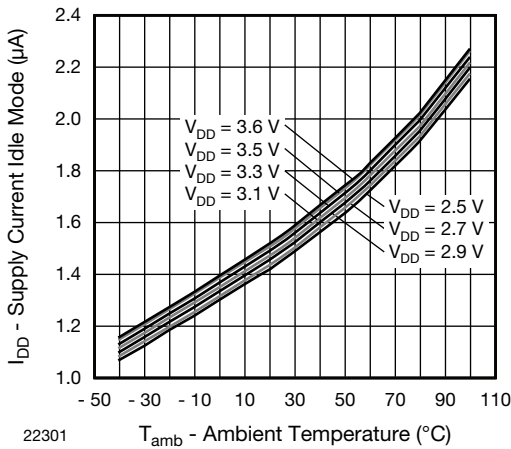

22301

Fig. 1 - Idle Current vs. Ambient Temperature

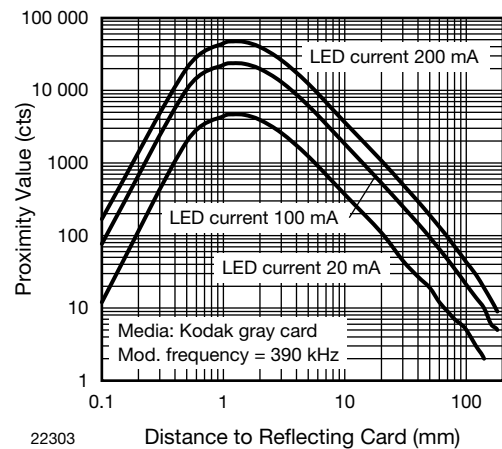

22303

Fig. 3 - Proximity Value vs. Distance

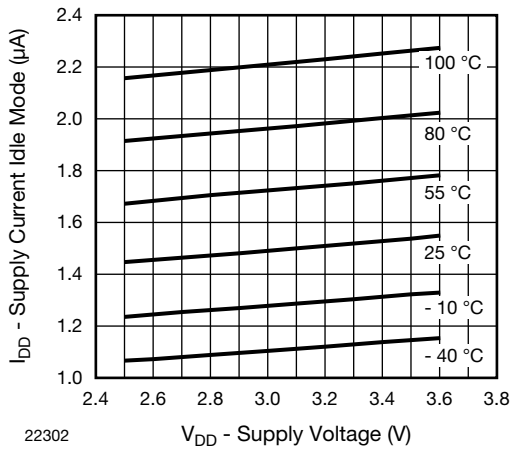

22302

Fig. 2 - Idle Current vs. V_{DD}

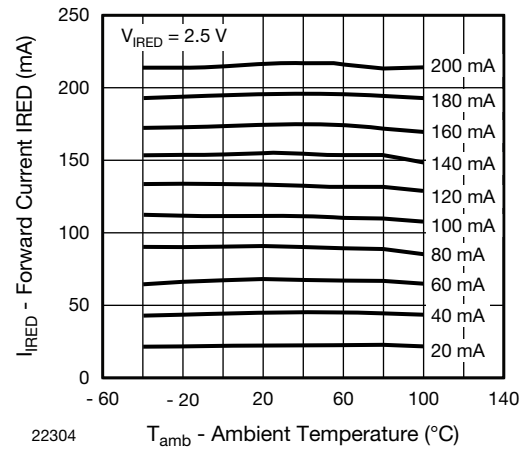

22304

Fig. 4 - Forward Current vs. Temperature

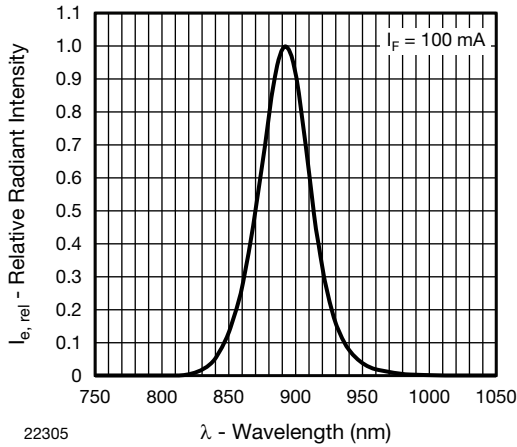

Fig. 5 - Relative Radiant Intensity vs. Wavelength

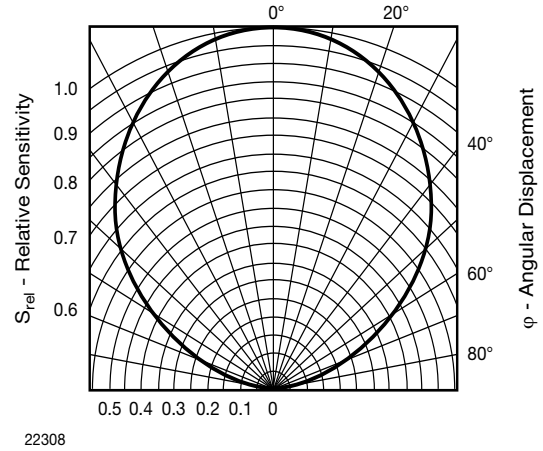

Fig. 8 - Relative Radiant Sensitivity vs. Angular Displacement

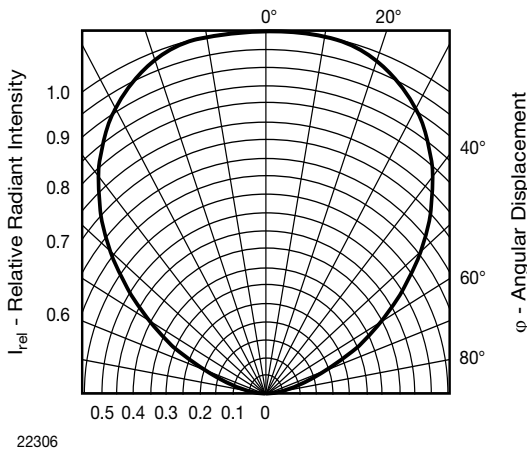

Fig. 6 - Relative Radiant Intensity vs. Angular Displacement

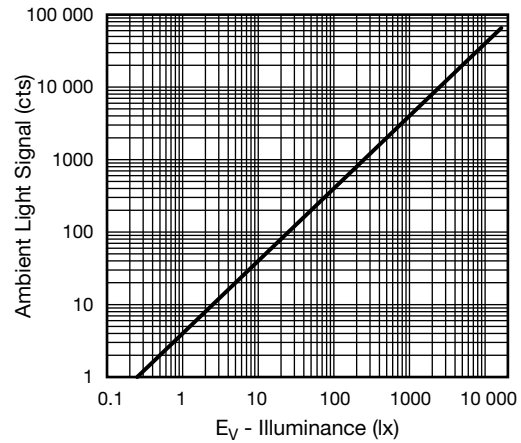

Fig. 9 - Ambient Light Value vs. Illuminance

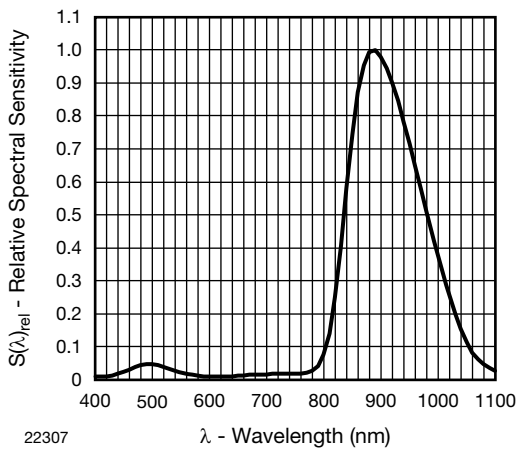

Fig. 7 - Relative Spectral Sensitivity vs. Wavelength

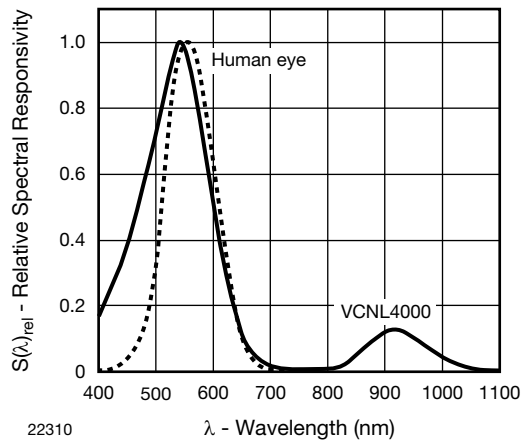
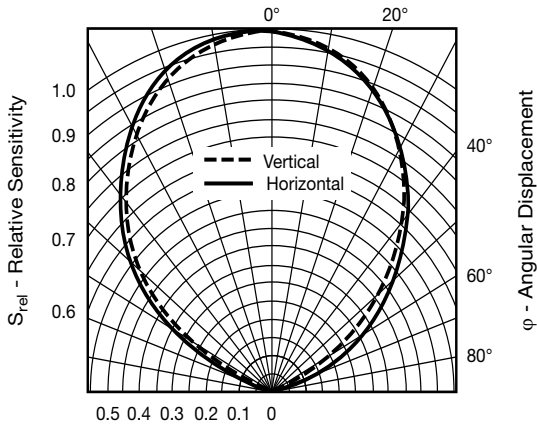

Fig. 10 - Relative Spectral Sensitivity vs. Wavelength



22311

Fig. 11 - Relative Radiant Sensitivity vs. Angular Displacement

APPLICATION INFORMATION

VCNL4000 is a cost effective solution of proximity and ambient light sensor with I²C Bus interface. The standard serial digital interface is easy to access “Proximity Signal” and “Light Intensity” without complex calculation and programming by external controller.

1. Application Circuit

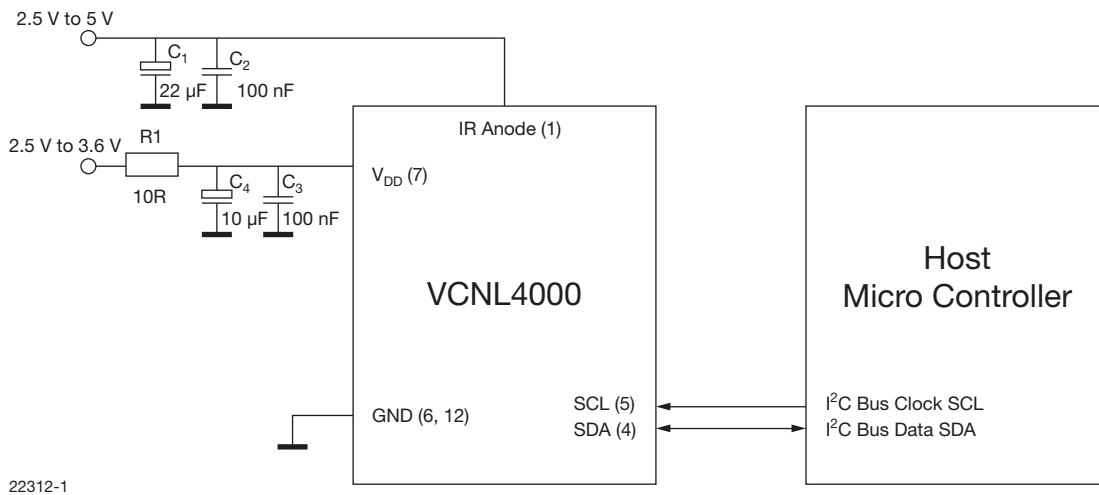

22312-1

Fig. 12 - Application Circuit
(x) = Pin Number

2. I²C Interface

The VCNL4000 contains twelve 8 bit registers for operation control, parameter setup and result buffering. All registers are accessible via I²C communication. Figure 13 shows the basic I²C communication with VCNL4000.

The built in I²C interface is compatible with all I²C modes (standard, fast and high speed).

I²C H-level range = 1.7 V to 5 V.

Please refer to the I²C specification from NXP for details.

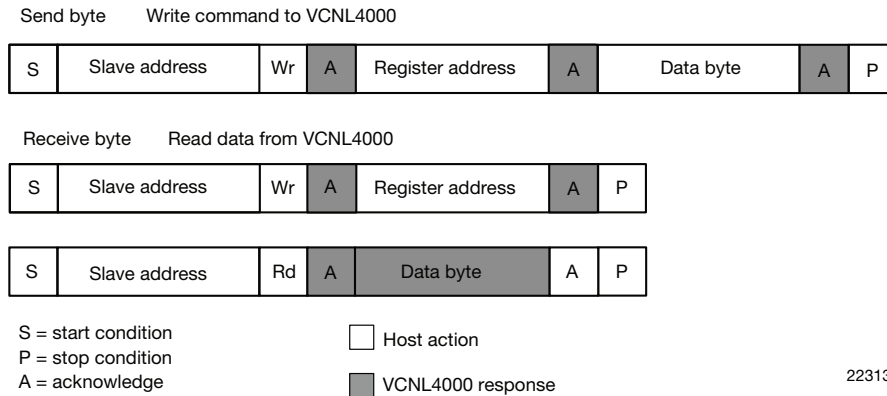

Fig. 13 - Send Byte/Receive Byte Protocol

Device Address

The VCNL4000 has a fix slave address for the host programming and accessing selection. The predefined 7 bit I²C bus address is set to 0010 011 = 13h. The least significant bit (LSB) defines read or write mode. Accordingly the bus address is set to 0010 011x = 26h for write, 27h for read.

Register Addresses

VCNL4000 has twelve user accessible 8 bit registers. The register addresses are 80h (register #0) to 8Bh (register #11).

REGISTER FUNCTIONS

Register #0 Command Register

Register address = 80h

The register #0 is for starting ambient light or proximity measurements. This register contains 2 flag bits for data ready indication.

TABLE 1 - COMMAND REGISTER #0							
Bit 7	Bit 6	Bit 5	Bit 4	Bit 3	Bit 2	Bit 1	Bit 0
config_lock	als_data_rdy	prox_data_rdy	als_od	prox_od	N/A	N/A	N/A
Description							
config_lock	Read only bit. Value = 1						
als_data_rdy	Read only bit. Value = 1 when ambient light measurement data is available in the result registers. This bit will be reset when one of the corresponding result registers (reg #5, reg #6) is read.						
prox_data_rdy	Read only bit. Value = 1 when proximity measurement data is available in the result registers. This bit will be reset when one of the corresponding result registers (reg #7, reg #8) is read.						
als_od	R/W bit. Starts a single on-demand measurement for ambient light. If averaging is enabled, starts a sequence of readings and stores the averaged result. Result is available at the end of conversion for reading in the registers #5(HB) and #6(LB).						
prox_od	R/W bit. Starts a single on-demand measurement for proximity. Result is available at the end of conversion for reading in the registers #7(HB) and #8(LB).						

Notes

- After a proximity start command [prox_od] a WAIT time of ≥ 400 µs should be inserted before any read out commands.
- With setting bit 3 and bit 4 at the same write command, a simultaneously measurement of ambient light and proximity is done.

**Register #1 Product ID Revision Register**

Register address = 81h. This register contains information about product ID and product revision.

Register data value of current revision = 11h.

TABLE 2 - PRODUCT ID REVISION REGISTER #1

Bit 7	Bit 6	Bit 5	Bit 4	Bit 3	Bit 2	Bit 1	Bit 0
Product ID				Revision ID			
Description							
Product ID		Read only bits. Value = 1					
Revision ID							

Register #2 without Function in Current Version

Register address = 82h.

Register #3 LED Current Setting for Proximity Mode

Register address = 83h. This register is to set the LED current value for proximity measurement.

The value is adjustable in steps of 10 mA from 0 mA to 200 mA.

This register also contains information about the used device fuse program ID.

TABLE 3 - IR LED CURRENT REGISTER #3

Bit 7	Bit 6	Bit 5	Bit 4	Bit 3	Bit 2	Bit 1	Bit 0
Fuse prog ID		IR LED current value					
Description							
Fuse prog ID		Read only bits. Information about fuse program revision used for initial setup/calibration of the device.					
IR LED current value		R/W bits. IR LED current = Value (dec.) x 10 mA. Valid Range = 0 to 20d. e.g. 0 = 0 mA, 1 = 10 mA, ..., 20 = 200 mA (2 = 20 mA = DEFAULT) LED Current is limited to 200 mA for values higher as 20d.					

Register #4 Ambient Light Parameter Register

Register address = 84h.

TABLE 4 - AMBIENT LIGHT PARAMETER REGISTER #4

Bit 7	Bit 6	Bit 5	Bit 4	Bit 3	Bit 2	Bit 1	Bit 0
Cont. conv. mode	N/A			Auto offset compensation	Averaging function (number of measurements per run)		
Description							
Bit 7 Cont. conversion mode		R/W bit. Continuous conversion mode. Enable = 1; Disable = 0 = DEFAULT This function can be used for performing faster ambient light measurements. Please refer to the application information chapter 3.3 for details about this function.					
Bit 3 Auto offset compensation		R/W bit. Automatic offset compensation. Enable = 1 = DEFAULT; Disable = 0 In order to compensate a technology, package or temperature related drift of the ambient light values there is a built in automatic offset compensation function. With active auto offset compensation the offset value is measured before each ambient light measurement and subtracted automatically from actual reading.					
Bit 0 to bit 2 Averaging function		R/W bits. Averaging function. Bit values sets the number of single conversions done during one measurement cycle. Result is the average value of all conversions. Number of conversions = $2^{\text{decimal_value}}$ e.g. 0 = 1 conv., 1 = 2 conv., 2 = 4 conv., ..., 7 = 128 conv. DEFAULT = 32 conv.					



Register #5 and #6 Ambient Light Result Register

Register address = 85h and 86h. These registers are the result registers for ambient light measurement readings. The result is a 16 bit value. The high byte is stored in register #5 and the low byte in register #6.

TABLE 5 - AMBIENT LIGHT RESULT REGISTER #5							
Bit 7	Bit 6	Bit 5	Bit 4	Bit 3	Bit 2	Bit 1	Bit 0
Description							
Read only bits. High byte (15:8) of ambient light measurement result							

TABLE 6 - AMBIENT LIGHT RESULT REGISTER #6							
Bit 7	Bit 6	Bit 5	Bit 4	Bit 3	Bit 2	Bit 1	Bit 0
Description							
Read only bits. Low byte (7:0) of ambient light measurement result							

Register #7 and #8 Proximity Measurement Result Register

Register address = 87h and 88h. These registers are the result registers for proximity measurement readings. The result is a 16 bit value. The high byte is stored in register #7 and the low byte in register #8.

TABLE 7 - PROXIMITY RESULT REGISTER #7							
Bit 7	Bit 6	Bit 5	Bit 4	Bit 3	Bit 2	Bit 1	Bit 0
Description							
Read only bits. High byte (15:8) of proximity measurement result							

TABLE 8 - PROXIMITY RESULT REGISTER #8							
Bit 7	Bit 6	Bit 5	Bit 4	Bit 3	Bit 2	Bit 1	Bit 0
Description							
Read only bits. Low byte (7:0) of proximity measurement result							

Register #9 Proximity Measurement Signal Frequency

Register address = 89h.

TABLE 9 - PROXIMITY MEASUREMENT SIGNAL FREQUENCY #9							
Bit 7	Bit 6	Bit 5	Bit 4	Bit 3	Bit 2	Bit 1	Bit 0
N/A						Proximity frequency	
Description							
Bit 0 and 1 Proximity frequency		R/W bits. Setting the proximity IR test signal frequency. The proximity measurement is using a square IR signal as measurement signal. Four different values are possible: 00 = 3.125 MHz 01 = 1.5625 MHz 02 = 781.25 kHz (DEFAULT) 03 = 390.625 kHz					



Register #10 Proximity Modulator Timing Adjustment

Register address = 8Ah.

TABLE 10 - PROXIMITY MODULATOR TIMING ADJUSTMENT #10							
Bit 7	Bit 6	Bit 5	Bit 4	Bit 3	Bit 2	Bit 1	Bit 0
Modulation delay time			N/A		Modulation dead Time		
Description							
Modulation delay time		R/W bits. Setting a delay time between IR LED signal and IR input signal evaluation. This function is for compensation of delays from IR LED and IR photo diode. Also in respect to the possibility for setting different proximity signal frequency. Correct adjustment is optimizing measurement signal level.					
Modulation dead Time		R/W bits. Setting a dead time in evaluation of IR signal at the slopes of the IR signal. This function is for reducing of possible disturbance effects. This function is reducing signal level and should be used carefully.					

Note

- The settings for best performance will be provided by Vishay. With first samples this is evaluated to: delay time = 4 and dead time = 1, with that register #10 should be programmed with: 129 (dez.)

Register #11 Ambient IR Light Level Register

Register address = 8Bh.

This register is not intended to be used by customer.

3. IMPORTANT APPLICATION HINTS AND EXAMPLES

3.1 Receiver standby mode

In standby mode the receiver has the lowest current consumption of about 1.5 µA. In this mode only the I²C interface is active. This is always valid, when there are no measurement demands for proximity and ambient light executed. Also the current sink for the IR-LED is inactive, so there is no need for changing register #3 (IR LED current).

3.2 Data Read

In order to get a certain register value, the register has to be addressed without data like shown in the following scheme. After this register addressing, the data from the addressed register is written after a subsequent read command.

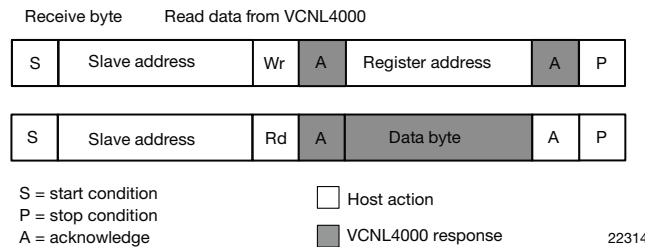

Fig. 14 - Send Byte/Receive Byte Protocol

The stop condition between these write and read sequences is not mandatory. It works also with a repeated start condition.

Note

- For reading out 2 (or more) subsequent registers like the result registers, it is not necessary to address each of the registers separately. After one read command the internal register counter is increased automatically and any subsequent read command is accessing the next register.

Example: read register "Ambient Light Result Register" #5 and #6:

Addressing:command: 26h, 85h (VCNL4000_I²C_Bus_Write_Adr., Ambient Light Result Register #5 [85])

Read register #5:command: 27h, data (VCNL4000_I²C_Bus_Read_Adr., {High Byte Data of Ambient Light Result Register #5 [85]})

Read register #6:command: 27h, data (VCNL4000_I²C_Bus_Read_Adr., {Low Byte Data of Ambient Light Result Register #6 [86]})

3.3 Continuous Conversion Mode in Ambient Light Measurement

In the following is a detail description of the function “continuous conversion” (bit 7 of register #4)

Standard mode (bit 7 of reg #4 = 0):

In standard mode the ambient light measurement is done during a fixed time frame of 100 ms. The single measurement itself takes actually only appr. 300 μ s.

The following figures show examples of this measurement timing in standard mode using averaging function 2 and 8 as examples for illustration (possible values up to 128).

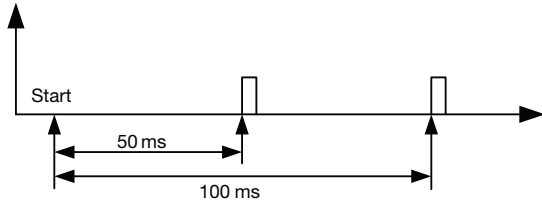

22315

Fig. 15 - Ambient Light Measurement with Averaging = 2; Final Measurement Result = Average of these 2 Measurements

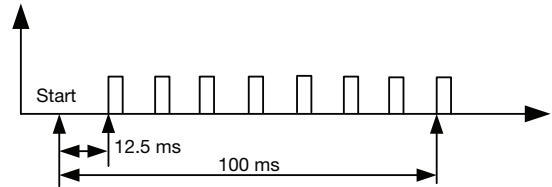

22316

Fig. 16 - Ambient Light Measurement with Averaging = 8; Final Measurement Result = Average of these 8 Measurements

Note

- \geq Independent of setting of averaging the result is available only after 100 ms.

Continuous conversion mode (bit7 of reg #4 = 1):

In continuous conversion mode the single measurements are done directly subsequent after each other.

See following examples in figure 17 and 18

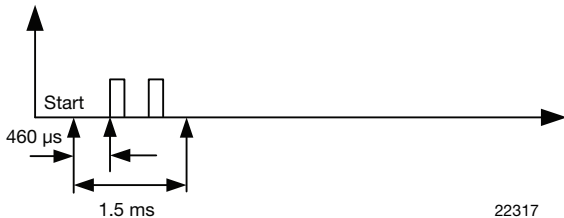

22317

Fig. 17 - Ambient Light Measurement with Averaging = 2; using Continuous Conversion Mode

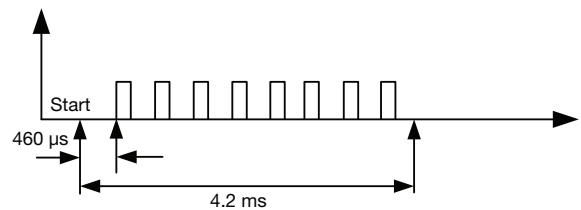

22318

Fig. 18 - Ambient Light Measurement with Averaging = 8; using Continuous Conversion Mode

PACKAGE DIMENSIONS in millimeters

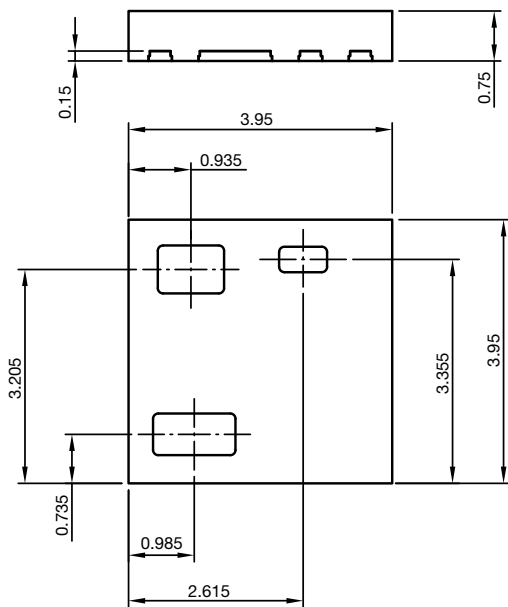
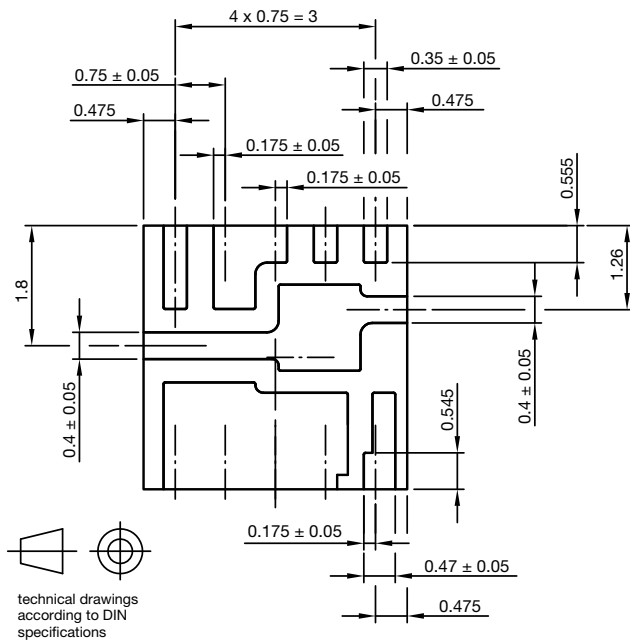

Drawing-No.: 6.550-5302.01-4
 Issue: prel; 16.02.10
 22320

Not indicated tolerances ± 0.1

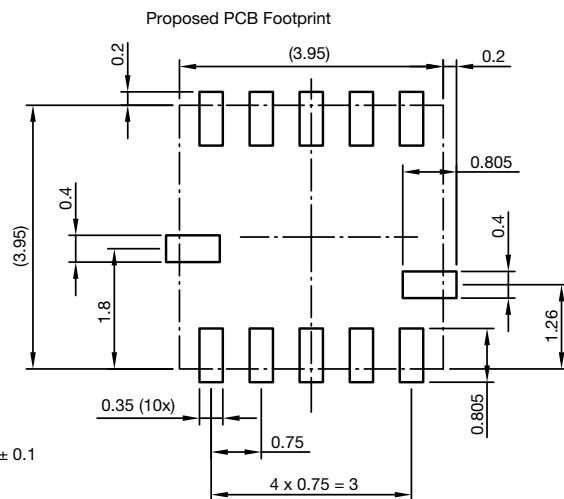
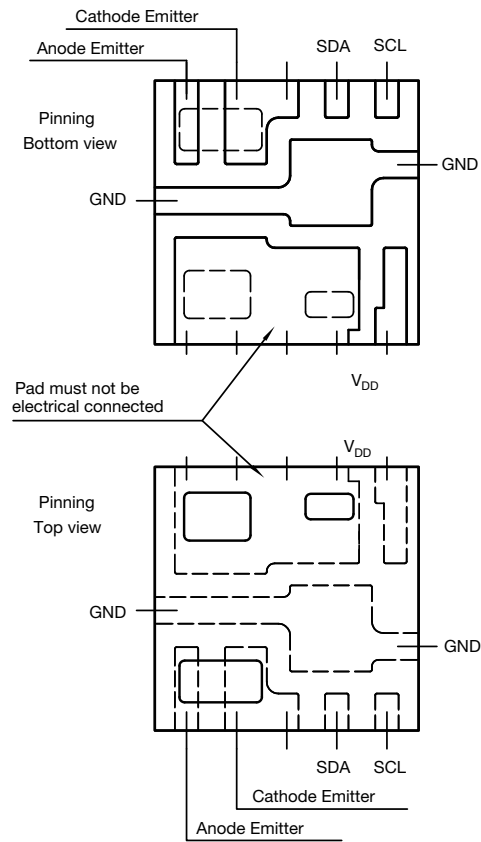

TAPE AND REEL DIMENSIONS in millimeters

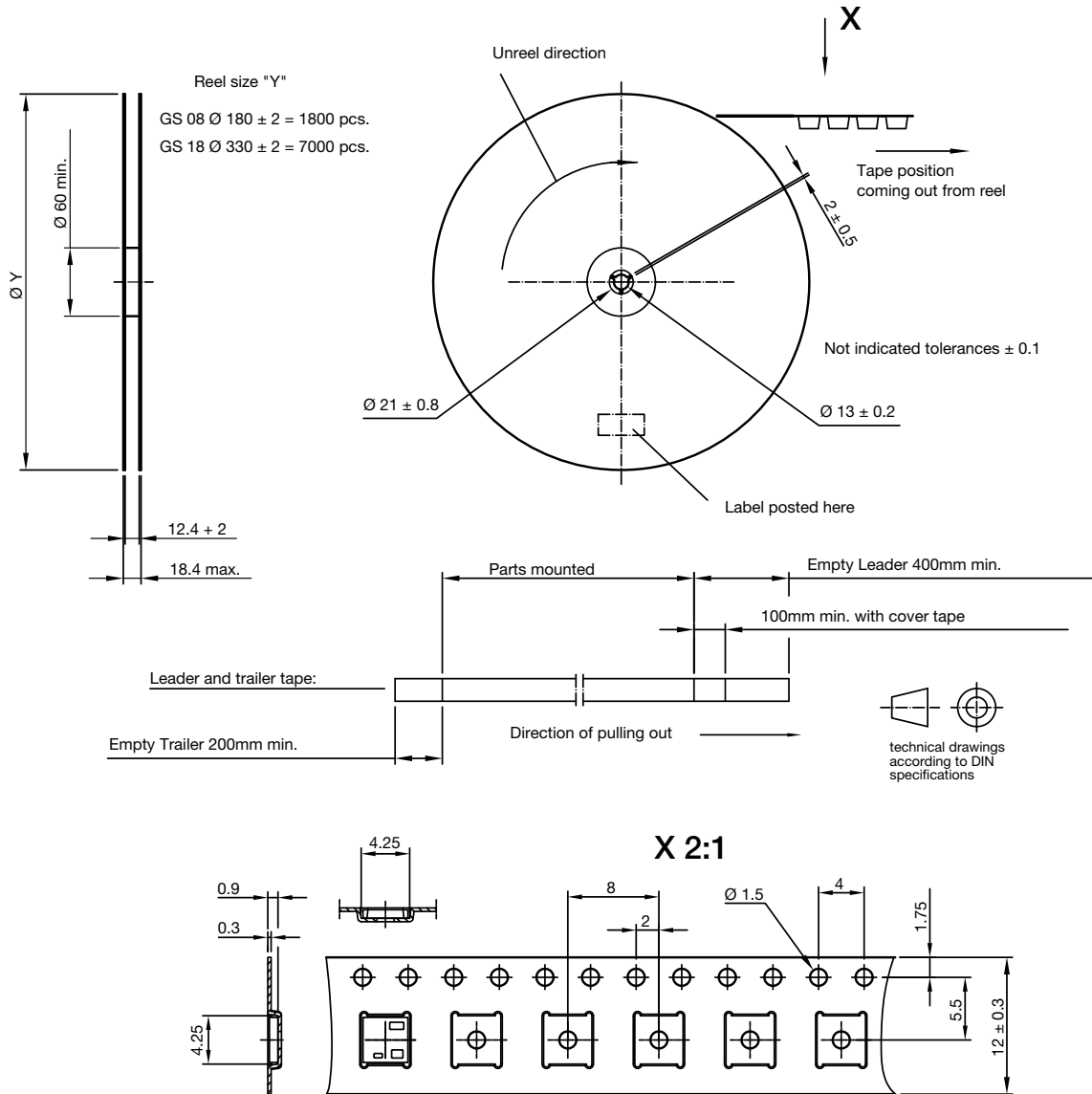

Drawing-No.: 9.800-510301-4
 Issue: prel; 02.12.09
 22319

SOLDER PROFILE

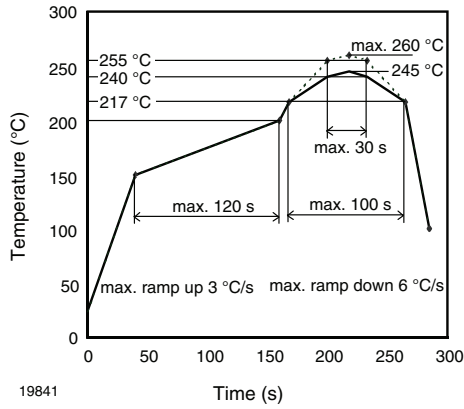

Fig. 19 - Lead (Pb)-free Reflow Solder Profile acc. J-STD-020

DRYPACK

Devices are packed in moisture barrier bags (MBB) to prevent the products from moisture absorption during transportation and storage. Each bag contains a desiccant.

FLOOR LIFE

Floor life (time between soldering and removing from MBB) must not exceed the time indicated on MBB label:

Floor life: 168 h

Conditions: $T_{amb} < 30\text{ }^{\circ}\text{C}$, $RH < 60\%$

Moisture sensitivity level 3, acc. to J-STD-020.

DRYING

In case of moisture absorption devices should be baked before soldering. Conditions see J-STD-020 or label. Devices taped on reel dry using recommended conditions 192 h at $40\text{ }^{\circ}\text{C}$ (+ 5 °C), $RH < 5\%$.