



Chipsmall Limited consists of a professional team with an average of over 10 year of expertise in the distribution of electronic components. Based in Hongkong, we have already established firm and mutual-benefit business relationships with customers from,Europe,America and south Asia,supplying obsolete and hard-to-find components to meet their specific needs.

With the principle of “Quality Parts,Customers Priority,Honest Operation,and Considerate Service”,our business mainly focus on the distribution of electronic components. Line cards we deal with include Microchip,ALPS,ROHM,Xilinx,Pulse,ON,Everlight and Freescale. Main products comprise IC,Modules,Potentiometer,IC Socket,Relay,Connector.Our parts cover such applications as commercial,industrial, and automotives areas.

We are looking forward to setting up business relationship with you and hope to provide you with the best service and solution. Let us make a better world for our industry!



## Contact us

Tel: +86-755-8981 8866 Fax: +86-755-8427 6832

Email & Skype: info@chipsmall.com Web: www.chipsmall.com

Address: A1208, Overseas Decoration Building, #122 Zhenhua RD., Futian, Shenzhen, China



# VEC2616

## Power MOSFET 60V, 80mΩ, 3A, -60V, 137mΩ, -2.5A, Complementary

This Power MOSFET is produced using ON Semiconductor's trench technology, which is specifically designed to minimize gate charge and low on resistance. This device is suitable for applications with low gate charge driving or low on resistance requirements.

### Features

- Low On-Resistance
- 4V drive
- Low-Profile Package
- Complementary N-Channel and P-Channel MOSFET
- ESD Diode-Protected Gate
- Pb-Free, Halogen Free and RoHS compliance

### Typical Applications

- Motor Driver

### SPECIFICATIONS

**ABSOLUTE MAXIMUM RATING** at Ta = 25°C (Note 1)

Parameter	Symbol	N-Channel	P-Channel	Unit
Drain to Source Voltage	V <sub>DSS</sub>	60	-60	V
Gate to Source Voltage	V <sub>GSS</sub>	±20	±20	V
Drain Current (DC)	I <sub>D</sub>	3	-2.5	A
Drain Current (Pulse) PW ≤ 10μs, duty cycle ≤ 1%	I <sub>DP</sub>	12	-10	A
Power Dissipation When mounted on ceramic substrate (900mm <sup>2</sup> × 0.8mm) 1unit	P <sub>D</sub>	0.9		W
Total Dissipation When mounted on ceramic substrate (900mm <sup>2</sup> × 0.8mm)	P <sub>T</sub>	1.0		W
Junction Temperature	T <sub>J</sub>	150		°C
Storage Temperature	T <sub>stg</sub>	-55 to +150		°C

Note 1 : Stresses exceeding those listed in the Maximum Ratings table may damage the device. If any of these limits are exceeded, device functionality should not be assumed, damage may occur and reliability may be affected.

### THERMAL RESISTANCE RATINGS

Parameter	Symbol	Value	Unit
Junction to Ambient When mounted on ceramic substrate (900mm <sup>2</sup> × 0.8mm) 1unit	R <sub>θJA</sub>	138.8	°C/W



**ON Semiconductor**<sup>®</sup>

www.onsemi.com

V <sub>DSS</sub>	R <sub>DS(on)</sub> Max	I <sub>D</sub> Max
N-Ch 60V	80mΩ@ 10V	3A
	106mΩ@ 4.5V	
	116mΩ@ 4V	
P-Ch -60V	137mΩ@ -10V	-2.5A
	180mΩ@ -4.5V	
	194mΩ@ -4V	

### ELECTRICAL CONNECTION N-Channel and P-Channel

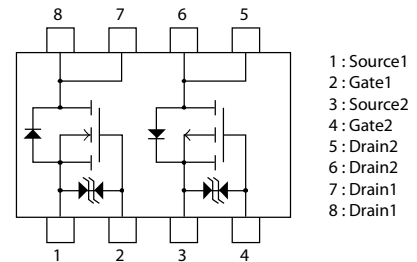

### PACKING TYPE : TL

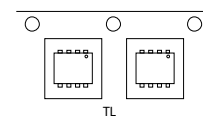

### MARKING

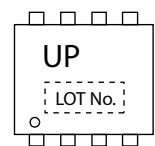

### ORDERING INFORMATION

See detailed ordering and shipping information on page 7 of this data sheet.

# VEC2616

## ELECTRICAL CHARACTERISTICS at Ta = 25°C (Note 2)

Parameter	Symbol	Conditions	Value			Unit
			min	typ	max	
[N-Channel]						
Drain to Source Breakdown Voltage	V(BR)DSS	ID=1mA, VGS=0V	60			V
Zero-Gate Voltage Drain Current	IDSS	VDS=60V, VGS=0V			1	μA
Gate to Source Leakage Current	IGSS	VGS=±16V, VDS=0V			±10	μA
Gate Threshold Voltage	VGS(th)	VDS=10V, ID=1mA	1.2		2.6	V
Forward Transconductance	gFS	VDS=10V, ID=1.5A		2.6		S
Static Drain to Source On-State Resistance	RDS(on)1	ID=1.5A, VGS=10V		62	80	mΩ
	RDS(on)2	ID=0.75A, VGS=4.5V		76	106	mΩ
	RDS(on)3	ID=0.75A, VGS=4V		83	116	mΩ
Input Capacitance	Ciss	VDS=20V, f=1MHz		505		pF
Output Capacitance	Coss			57		pF
Reverse Transfer Capacitance	Crss			37		pF
Turn-ON Delay Time	t <sub>d(on)</sub>		See specified Test Circuit		7.3	
Rise Time	t <sub>r</sub>			7.5		ns
Turn-OFF Delay Time	t <sub>d(off)</sub>			41		ns
Fall Time	t <sub>f</sub>			22		ns
Total Gate Charge	Qg	VDS=30V, VGS=10V, ID=3A			10	
Gate to Source Charge	Qgs			1.6		nC
Gate to Drain "Miller" Charge	Qgd			2.1		nC
Forward Diode Voltage	VSD	IS=3A, VGS=0V		0.81	1.2	V
[P-Channel]						
Drain to Source Breakdown Voltage	V(BR)DSS	ID=-1mA, VGS=0V	-60			V
Zero-Gate Voltage Drain Current	IDSS	VDS=-60V, VGS=0V			-1	μA
Gate to Source Leakage Current	IGSS	VGS=±16V, VDS=0V			±10	μA
Gate Threshold Voltage	VGS(th)	VDS=-10V, ID=-1mA	-1.2		-2.6	V
Forward Transconductance	gFS	VDS=-10V, ID=-1.5A		3.9		S
Static Drain to Source On-State Resistance	RDS(on)1	ID=-1.5A, VGS=-10V		105	137	mΩ
	RDS(on)2	ID=-0.75A, VGS=-4.5V		128	180	mΩ
	RDS(on)3	ID=-0.75A, VGS=-4V		138	194	mΩ
Input Capacitance	Ciss	VDS=-20V, f=1MHz		420		pF
Output Capacitance	Coss			54		pF
Reverse Transfer Capacitance	Crss			44		pF
Turn-ON Delay Time	t <sub>d(on)</sub>		See specified Test Circuit		6.4	
Rise Time	t <sub>r</sub>			9.8		ns
Turn-OFF Delay Time	t <sub>d(off)</sub>			65		ns
Fall Time	t <sub>f</sub>			36		ns
Total Gate Charge	Qg	VDS=-30V, VGS=-10V, ID=-2.5A			11	
Gate to Source Charge	Qgs			1.4		nC
Gate to Drain "Miller" Charge	Qgd			2		nC
Forward Diode Voltage	VSD	IS=-2.5A, VGS=0V		-0.83	-1.2	V

Note 2 : Product parametric performance is indicated in the Electrical Characteristics for the listed test conditions, unless otherwise noted. Product performance may not be indicated by the Electrical Characteristics if operated under different conditions.

# VEC2616

## Switching Time Test Circuit [N-Channel]

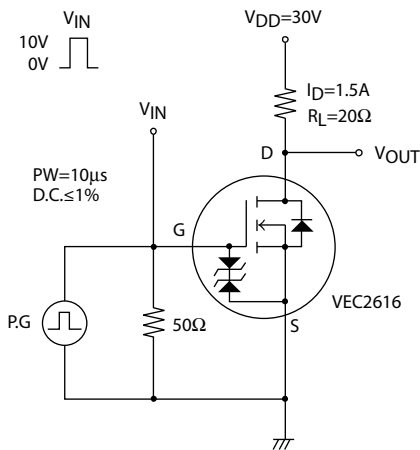

## [P-Channel]

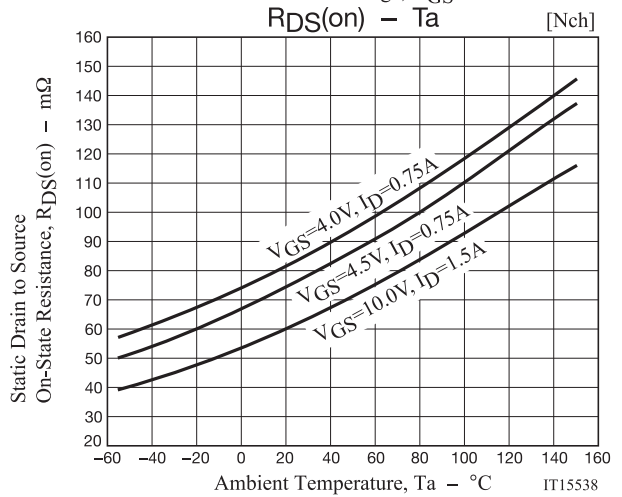
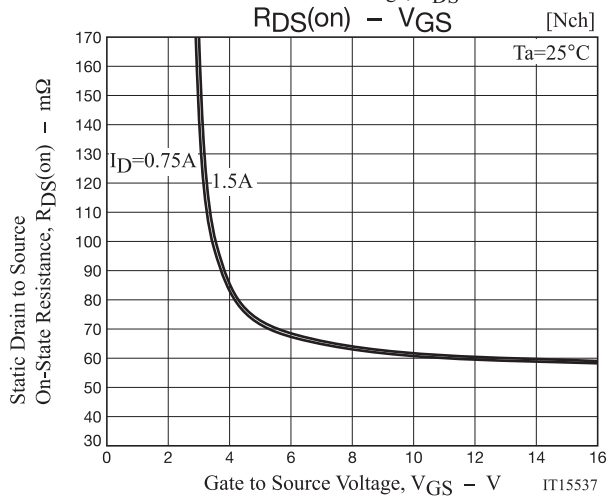
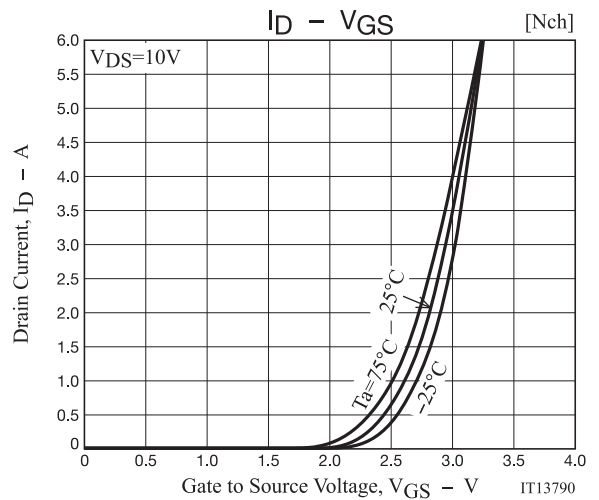
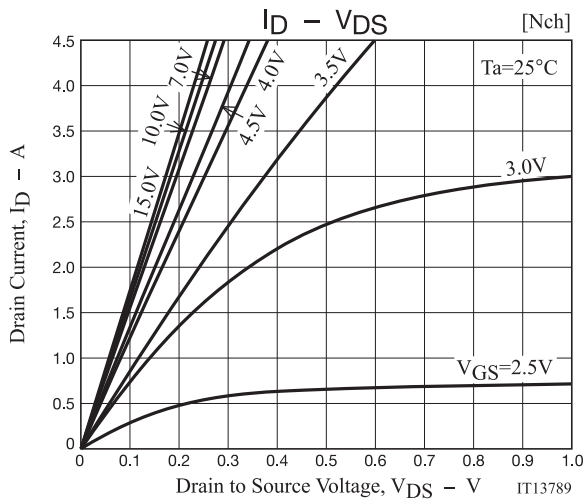
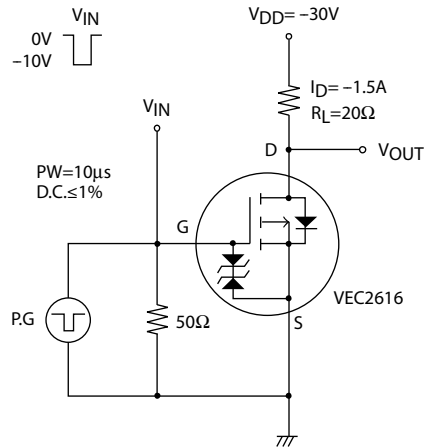

# VEC2616

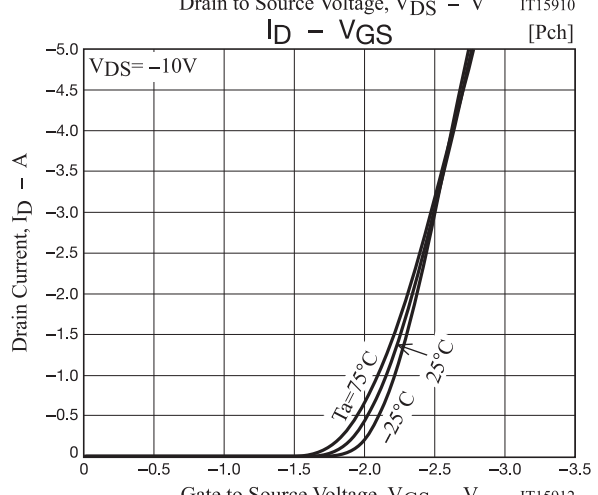
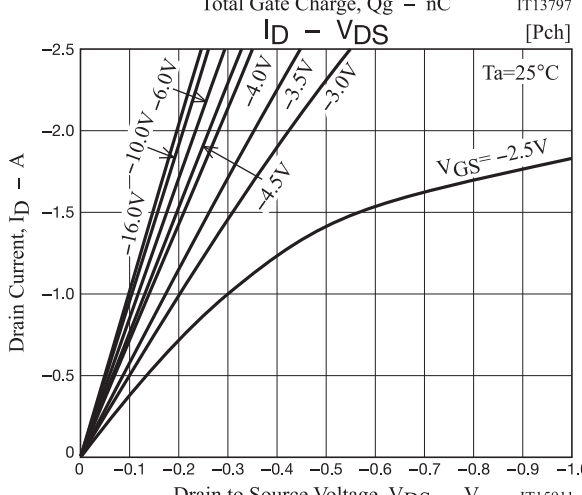
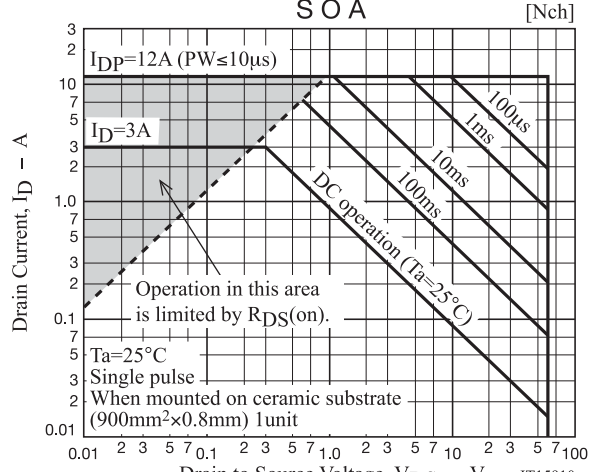
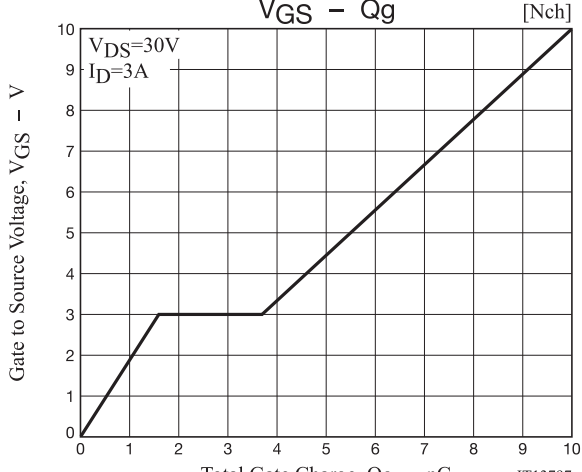
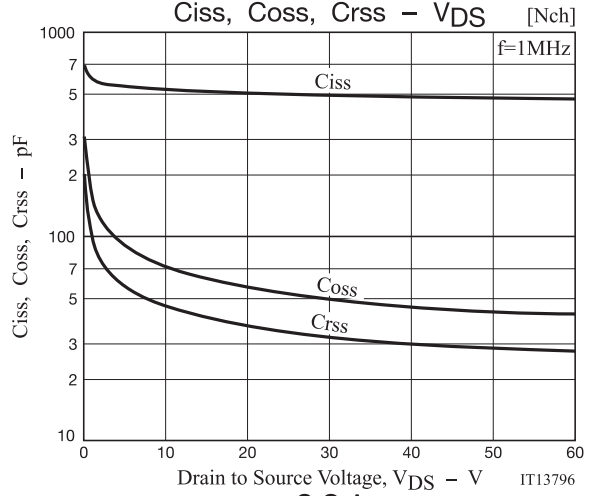
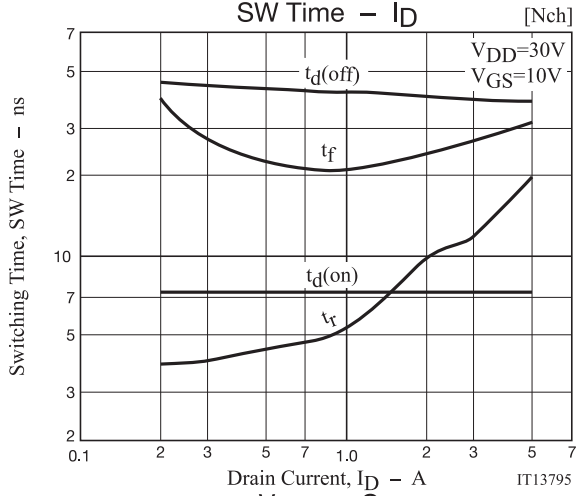
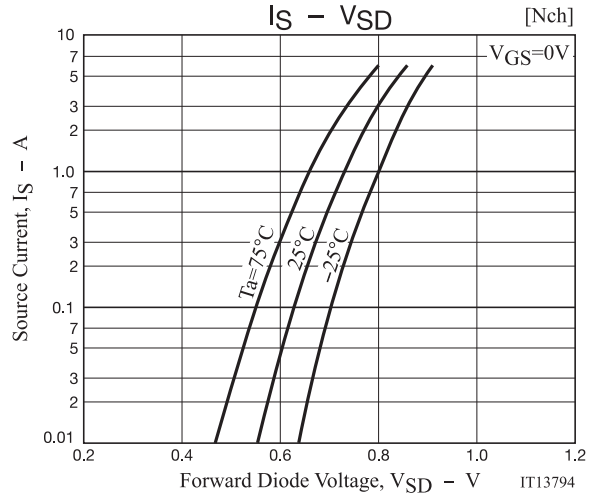
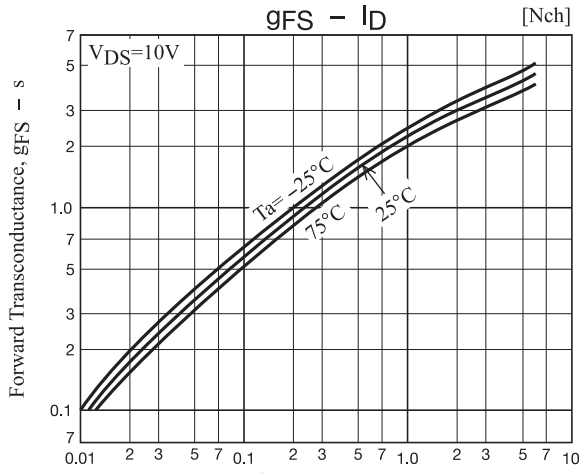

# VEC2616

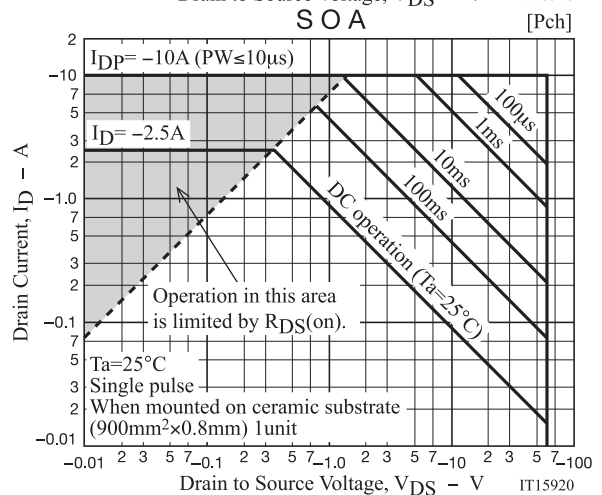
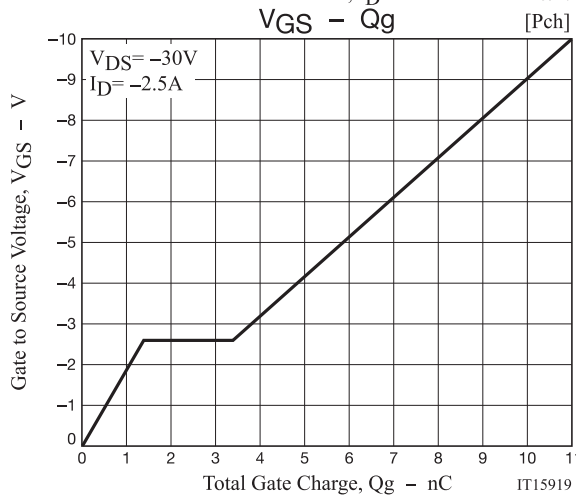
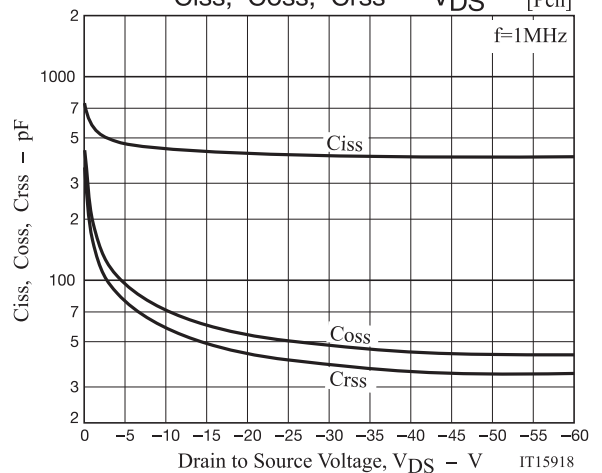
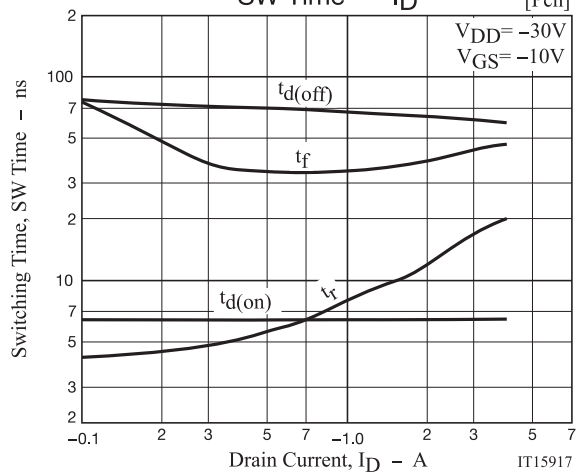
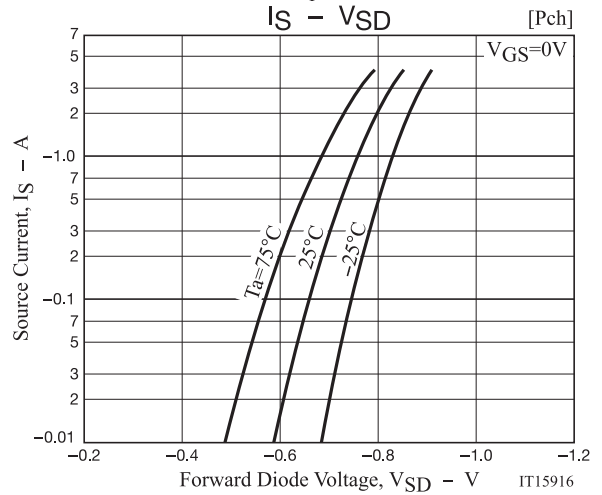
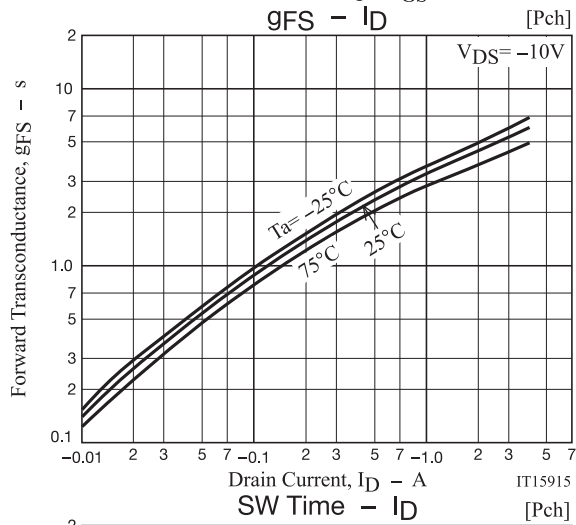
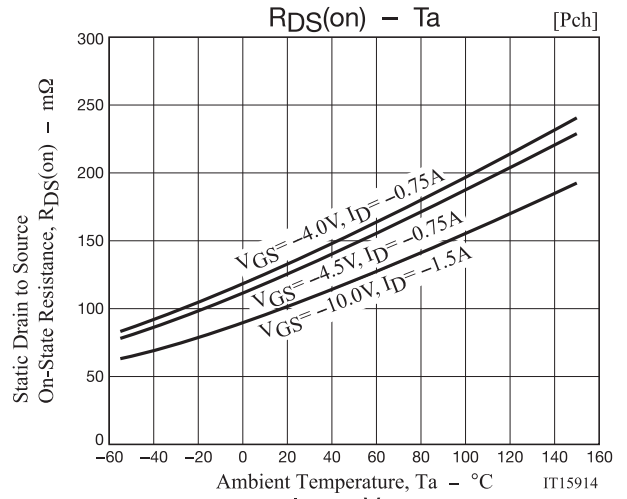
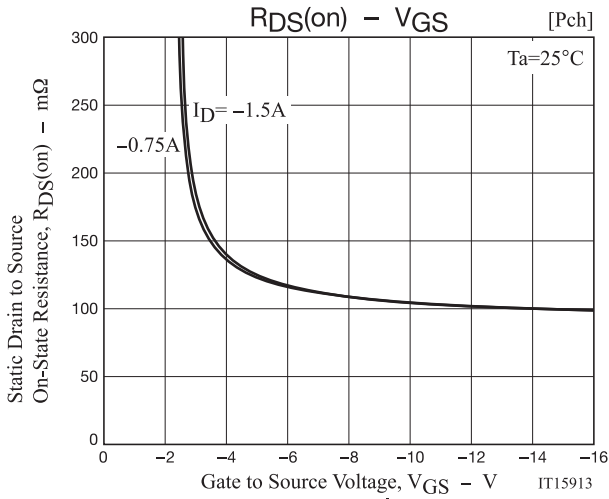

# VEC2616

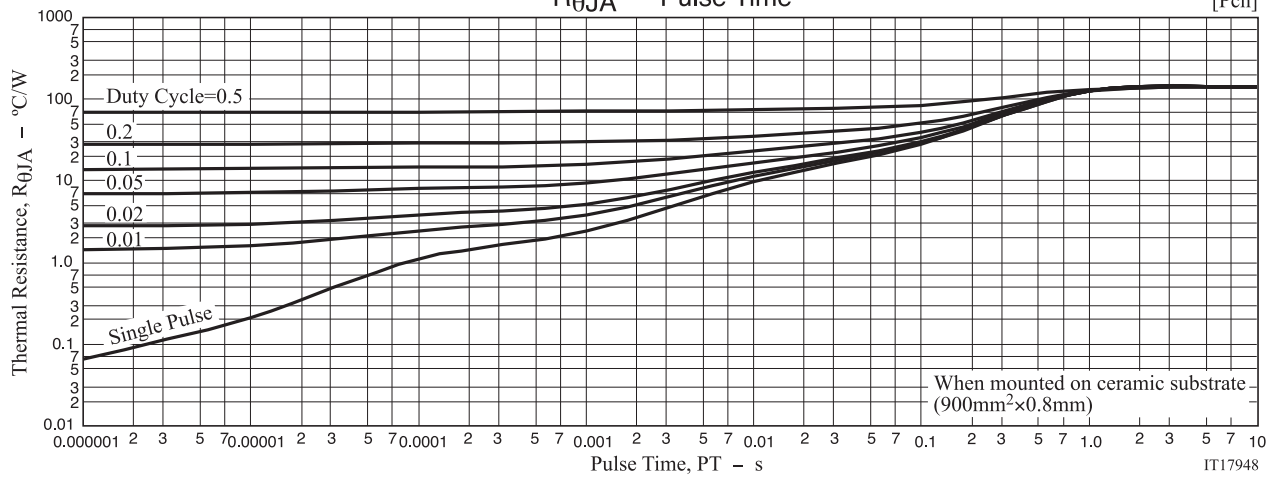
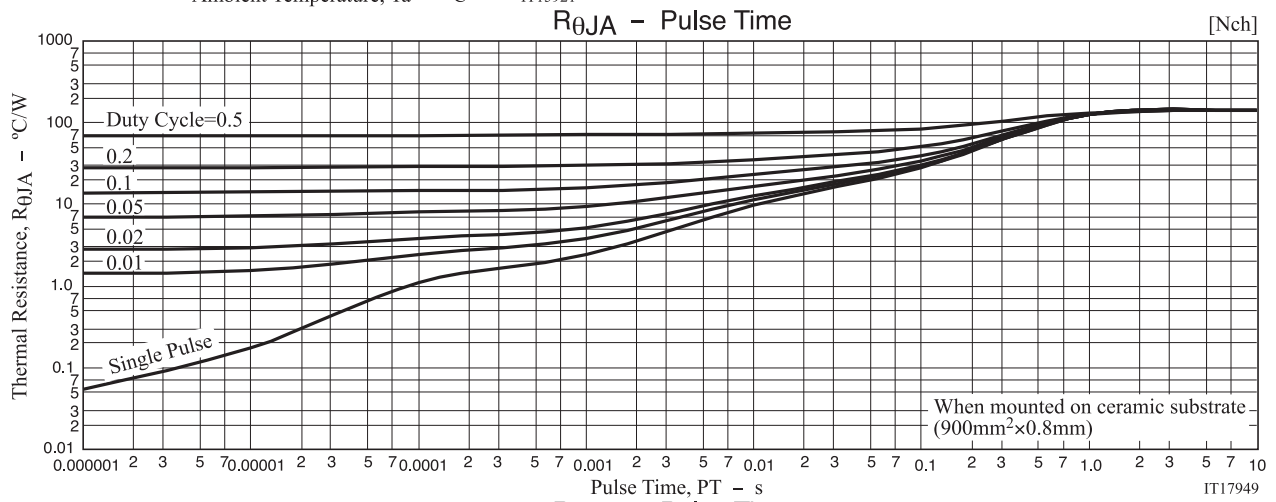
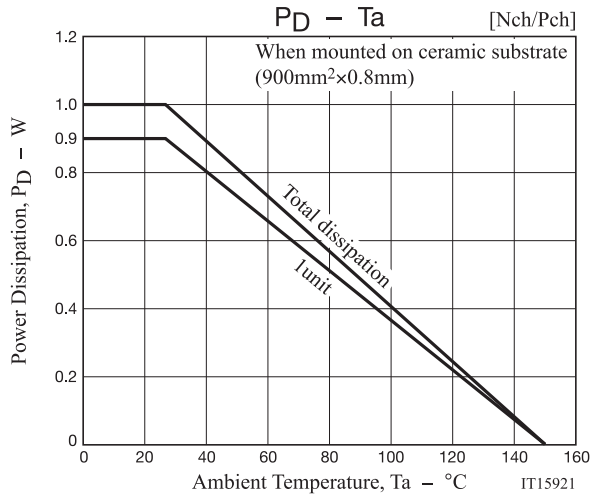

# VEC2616

## PACKAGE DIMENSIONS

unit : mm

SOT-28FL / VEC8  
CASE 318AH  
ISSUE O

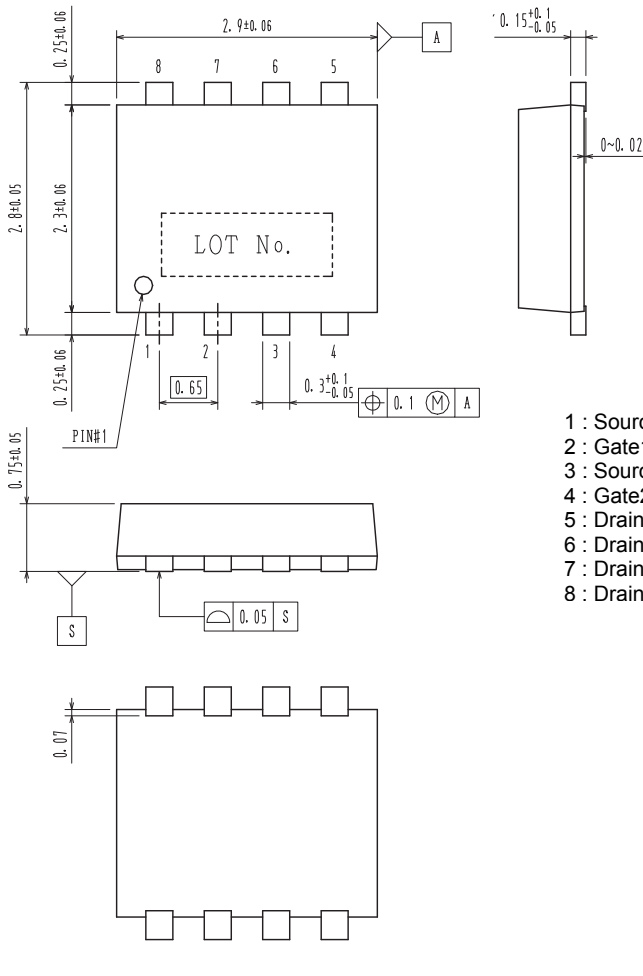

- 1 : Source1
- 2 : Gate1
- 3 : Source2
- 4 : Gate2
- 5 : Drain2
- 6 : Drain2
- 7 : Drain1
- 8 : Drain1

### Recommended Soldering Footprint

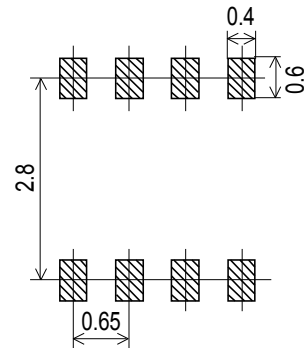

## ORDERING INFORMATION

Device	Marking	Package	Shipping (Qty / Packing)
VEC2616-TL-H	UP	SOT-28FL / VEC8 (Pb-Free / Halogen Free)	3,000 / Tape & Reel
VEC2616-TL-W			

† For information on tape and reel specifications, including part orientation and tape sizes, please refer to our Tape and Reel Packaging Specifications Brochure, BRD8011/D. [http://www.onsemi.com/pub\\_link/Collateral/BRD8011-D.PDF](http://www.onsemi.com/pub_link/Collateral/BRD8011-D.PDF)

Note on usage : Since the VEC2616 is a MOSFET product, please avoid using this device in the vicinity of highly charged objects.

ON Semiconductor and the ON logo are registered trademarks of Semiconductor Components Industries, LLC (SCILLC) or its subsidiaries in the United States and/or other countries. SCILLC owns the rights to a number of patents, trademarks, copyrights, trade secrets, and other intellectual property. A listing of SCILLC's product/patent coverage may be accessed at [www.onsemi.com/site/pdf/Patent-Marking.pdf](http://www.onsemi.com/site/pdf/Patent-Marking.pdf). SCILLC reserves the right to make changes without further notice to any products herein. SCILLC makes no warranty, representation or guarantee regarding the suitability of its products for any particular purpose, nor does SCILLC assume any liability arising out of the application or use of any product or circuit, and specifically disclaims any and all liability, including without limitation special, consequential or incidental damages. "Typical" parameters which may be provided in SCILLC data sheets and/or specifications can and do vary in different applications and actual performance may vary over time. All operating parameters, including "Typicals" must be validated for each customer application by customer's technical experts. SCILLC does not convey any license under its patent rights nor the rights of others. SCILLC products are not designed, intended, or authorized for use as components in systems intended for surgical implant into the body, or other applications intended to support or sustain life, or for any other application in which the failure of the SCILLC product could create a situation where personal injury or death may occur. Should Buyer purchase or use SCILLC products for any such unintended or unauthorized application, Buyer shall indemnify and hold SCILLC and its officers, employees, subsidiaries, affiliates, and distributors harmless against all claims, costs, damages, and expenses, and reasonable attorney fees arising out of, directly or indirectly, any claim of personal injury or death associated with such unintended or unauthorized use, even if such claim alleges that SCILLC was negligent regarding the design or manufacture of the part. SCILLC is an Equal Opportunity/Affirmative Action Employer. This literature is subject to all applicable copyright laws and is not for resale in any manner.