



Chipsmall Limited consists of a professional team with an average of over 10 year of expertise in the distribution of electronic components. Based in Hongkong, we have already established firm and mutual-benefit business relationships with customers from,Europe,America and south Asia,supplying obsolete and hard-to-find components to meet their specific needs.

With the principle of “Quality Parts,Customers Priority,Honest Operation,and Considerate Service”,our business mainly focus on the distribution of electronic components. Line cards we deal with include Microchip,ALPS,ROHM,Xilinx,Pulse,ON,Everlight and Freescale. Main products comprise IC,Modules,Potentiometer,IC Socket,Relay,Connector.Our parts cover such applications as commercial,industrial, and automotives areas.

We are looking forward to setting up business relationship with you and hope to provide you with the best service and solution. Let us make a better world for our industry!



Contact us

Tel: +86-755-8981 8866 Fax: +86-755-8427 6832

Email & Skype: info@chipsmall.com Web: www.chipsmall.com

Address: A1208, Overseas Decoration Building, #122 Zhenhua RD., Futian, Shenzhen, China



EMIGUARD® (Three-Terminal Varistor-Capacitor)
VFS6V Series Reference Specification

1.Scope

This reference specification applies to EMIGUARD® (Three-terminal Varistor-Capacitor).

2.Part Numbering

(Ex.) VF S 6 V D8 1E 221 U31 A
 ① ② ③ ④ ⑤ ⑥ ⑦ ⑧ ⑨

- ①Product ID (EMIGUARD® Lead Type)
- ②Structure S : Built-in Ferrite Beads Type
- ③Style
- ④Features
- ⑤Temperature Characteristics
- ⑥Rated Voltage
- ⑦Capacitance □□□

↓
Marked three digits system.(Ex. 220pF→221)

- ⑧Lead Type T51 : Bulk / U31 : Taping (For the details, see item 9.)
- ⑨Packaging Code B : Bulk / A : Ammo Pack

(Bulk)

Customer Part Number	Part Number
	VFS6VD81E221T51B

(Taping)

Customer Part Number	Part Number
	VFS6VD81E221U31A

3.Rating

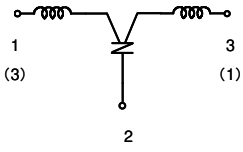
Temperature Characteristics	D8 (± 30%) ²⁰
Capacitance value ,Tolerance	220 pF±20%
Rated Voltage	25 V(DC)
Rated Current	6A (DC)
Insulation Resistance	50MΩ min.
Varistor Voltage(V _{1mA})	50V ± 20%
Voltage Ratio	1.10 max.(V _{1mA} / V _{0.1mA})
Operating Temperature	-40 to +105°C
Storage Temperature	-40 to +105°C
Equivalent Circuit	
Unit Mass (Typical value)	0.48g

4.Style and Dimensions

See item 9.

5.Marking

- Trade Mark : Marked as 
- Capacitance : Marked three digits system. (221)
- Rated Voltage : Marked voltage value. (25)
- Varistor Voltage : Marked voltage value. (50)

6.Testing Condition

<p><Unless otherwise specified></p> <p>Temperature : Ordinary Temperature 15 to 35 °C</p> <p>Humidity : Ordinary Humidity 25 to 85%(RH)</p>	<p><In case of doubt></p> <p>Temperature : 20±2°C</p> <p>Humidity : 60 to 70%</p> <p>Atmospheric Pressure : 86 to 106 kPa</p>
---	---

7. Electrical Performance

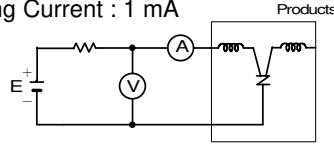
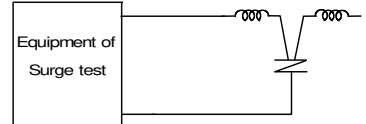
No.	Item	Specification	Test Method												
7.1	Style and Dimension	Meet item 9.	Visual Inspection and measured with Slide Calipers.												
7.2	Marking	Marking is able to be read easily.	Visual Inspection.												
7.3	Capacitance and Tolerance	Meet item 3.	Frequency : 1±0.1kHz Test Voltage : 1±0.2 V(rms)												
7.4	Insulation Resistance(I.R.)		Test Voltage : Rated Voltage Time : 30±5 minutes through a suitable resistor 1MΩ.												
7.5	Varistor Voltage		Measuring Current : 1 mA 												
7.6	Voltage Ratio		Measuring Current : 0.1 mA , 1mA Measuring circuit : See 7.5 Calculate expression : $V_1 / V_{0.1}$ V_1 : Varistor Voltage at 1mA $V_{0.1}$: Varistor Voltage at 0.1 mA												
7.7	Resistance to Surge Current	Meet Table 1. <table border="1" style="width: 100%; border-collapse: collapse;"> <tr> <td style="width: 50%;">Appearance</td> <td>No damaged.</td> </tr> <tr> <td>Varistor Voltage Change</td> <td>within ±10%</td> </tr> </table>	Appearance	No damaged.	Varistor Voltage Change	within ±10%	The surge current shall be applied twice to them.  Wave form : 8/20 μ s Peak current : 100A The number of Times : 2 times (5 minutes interval)								
Appearance	No damaged.														
Varistor Voltage Change	within ±10%														
7.8	Characteristic(TC)		Capacitance shall be measured at each step specified in Table 2 after reaching the thermal equilibrium. The capacitance change against the capacitance at step 3 shall be calculated. <u>Table 2</u> <table border="1" style="width: 100%; border-collapse: collapse; text-align: center;"> <tr> <td>Step</td> <td>1</td> <td>2</td> <td>3</td> <td>4</td> <td>5</td> </tr> <tr> <td>Temp. (°C)</td> <td>+20±2</td> <td>-40±2</td> <td>+20±2</td> <td>+105±2</td> <td>+20±2</td> </tr> </table>	Step	1	2	3	4	5	Temp. (°C)	+20±2	-40±2	+20±2	+105±2	+20±2
Step	1	2	3	4	5										
Temp. (°C)	+20±2	-40±2	+20±2	+105±2	+20±2										
7.9	Temperature Cycle	Meet Table 3. <table border="1" style="width: 100%; border-collapse: collapse;"> <tr> <td style="width: 50%;">Appearance</td> <td>No damaged.</td> </tr> <tr> <td>Capacitance Change</td> <td>within ± 20%</td> </tr> <tr> <td>Varistor Voltage Change</td> <td>within ± 15%</td> </tr> <tr> <td>Insulation Resistance</td> <td>10MΩ min.</td> </tr> </table>	Appearance	No damaged.	Capacitance Change	within ± 20%	Varistor Voltage Change	within ± 15%	Insulation Resistance	10MΩ min.	1 cycle Step 1 -40°C (+0°C,-3°C) / 30 min. Step 2 Ordinary Temp. / within 5 min. Step 3 +105°C (+3°C,-0°C) / 30 min. Step 4 Ordinary Temp. / within 5 min. Total 10 cycles Then measured after exposure in the room condition for 1 to 12 hours.				
Appearance	No damaged.														
Capacitance Change	within ± 20%														
Varistor Voltage Change	within ± 15%														
Insulation Resistance	10MΩ min.														
7.10	Humidity		Temperature : 40 ± 2°C Humidity : 90 to 95 %(RH) Time : 500 hours(+24-0 hours) Then measured after exposure in the room condition for 4 to 24hours.												
7.11	Humidity Load		Temperature : 40 ± 2°C Humidity : 90 to 95 %(RH) Applying Voltage : 35V(DC) Time : 500 hours(+24-0 hours) Then measured after exposure in the room condition for 4 to 24hours.												

No.	Item	Specification	Test Method
7.12	Heat Life	Meet Table 3.	Temperature : 105 ± 3°C Applying Voltage : 35V(DC) Time : 500 hours(+24-0 hours) Then measured after exposure in the room condition for 4 to 24hours.
7.13	Solderability	Along the circumference of terminal shall be covered with new solder at least 90%.	Flux : Ethanol solution of rosin,25(wt)% (dipped for 5 to 10 seconds) Solder : Sn-3.0Ag-0.5Cu Solder Temperature : 245±5°C Immersion Time : 2 ± 0.5 seconds Immersion Depth : 1.5 to 2.0 mm from the bottom of the body.
7.14	Resistance to Soldering Heat	Meet Table 3.	Solder : Sn-3.0Ag-0.5Cu Solder Temperature : 270 ± 5 °C Immersion Time : 3± 0.5 seconds Immersion Depth : 1.5 to 2.0 mm from the bottom of the body. Then measured after exposure in the room condition for 4 to 24hours.

8.Mounting Hole

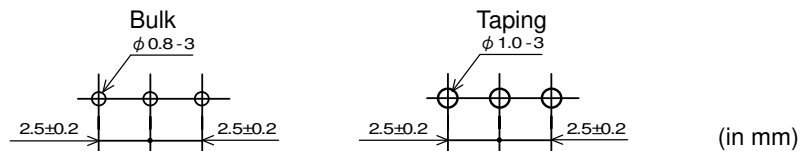

9.Style and Dimension
9.1 Bulk Type

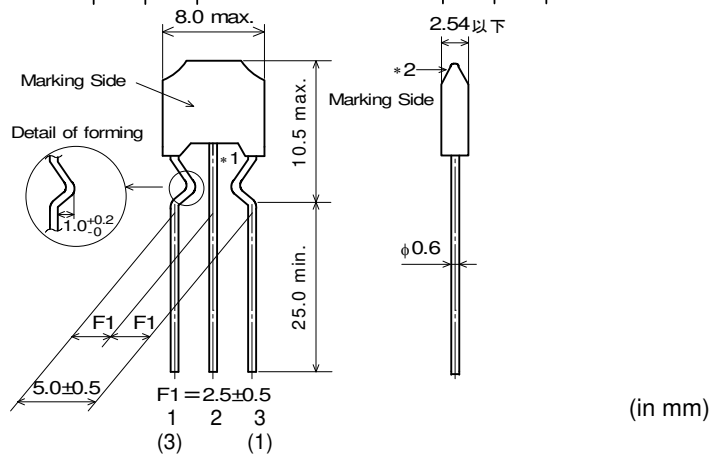

- *1 Bottom of dielectric may be exposed.
- *2 There should not be the exposure of the ferrite bead if a hole is on top of ferrite bead.

9.2 Taping Type

(All symbols in the illustrations below are described in Table 4.)

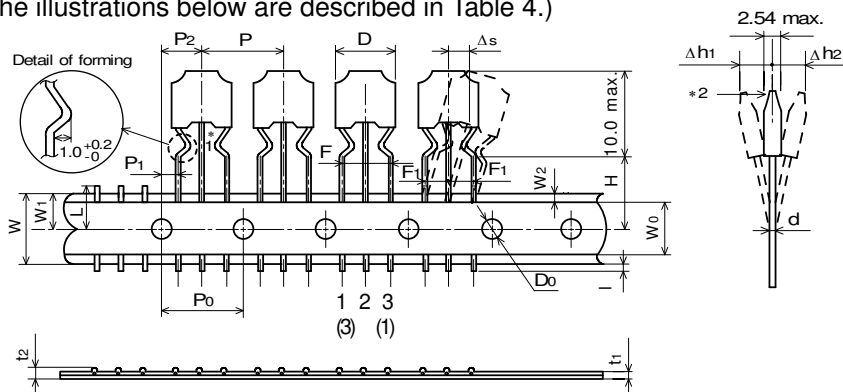

- *1. Bottom of dielectric may be exposed.
- *2. There should not be the exposure of the ferrite bead if a hole is on the top of ferrite bead.

Table 4

Code	Description	Dimensions	Remark
P	Pitch of Component	12.7	Product Inclination ΔS Determines Crossing
P0	Pitch of Sprocket Hole	12.7±0.2	
P1	Length from Hole Center to Lead	3.85±0.7	
P2	Length from Hole Center to Component Center	6.35±1.3	Shift In Tape In Direction of Feed
D	Width of Body	8.0 max.	
ΔS	Deviation along tape, Left or Right	0±1.0	
W	Carrier Tape Width	18.0±0.5	
W1	Position of Sprocket Hole	9.0± ⁰ _{0.5}	Tape Widthwise Shift
l	Protrusion Length	+0.5 ~ -1.0	
D0	Diameter of Sprocket Hole	φ 4.0±0.1	
d	Lead Diameter	φ 0.6	
t1	Total Tape Thickness	0.7±0.2	Includes Thickness of Bonding Tape
t2	Total Thickness, Tape and Lead Wire	1.5 max.	
Δh1	Deviation across Tape,front	1.0 max.	
Δh2	Deviation across Tape,rear	1.0 max.	
L	Portion to Cut in Case of Defect	11.0± ⁰ _{1.0}	
W0	Hold Down Tape Width	12.0±0.5	
W2	Hold Down Tape Position	1.5±1.5	
H	Lead length between sprocket hole and forming position	18.5±1.0	
F	Lead Spacing	5.0± ^{0.8} _{0.2}	
F1		2.5± ^{0.4} _{0.2}	

(in mm)

10. Taping

10.1 (1) A maximum of 0.3% of the components quantity per reel or Ammo pack may be missing without consecutive missing components.

(2) The adhesive power of the tape shall have over 2.94N at the following condition.

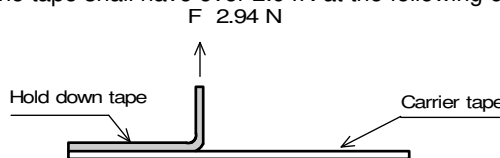

(3) Splicing method of tape

1. Carrier tape

Carrier tape shall be spliced by cellophane tape.
Overall thickness shall be less than 1.05 mm.

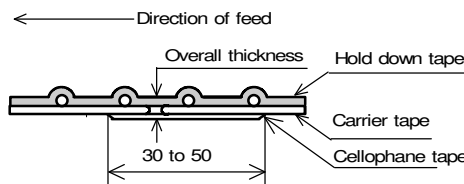

(in mm)

2. Hold down tape

Hold down tape shall be spliced with overlapping.
Overall thickness shall be less than 1.05 mm.

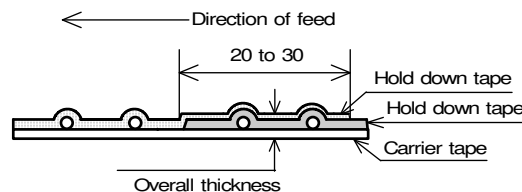

(in mm)

3. Both carrier tape and hold down tape

Both tapes shall be cut zigzag and spliced with splicing tape.

11. Packing

11.1 Packing quantity

Minimum Packing Form and Quantity

Terminal Configuration	A Unit Quantity	Packing Form
Bulk	250 pcs.	In a plastic bag
Taping	2000 pcs.	In an Ammo pack

* A quantity in a container is depending on a quantity of an order.

11.2 Packing Form

(1) Bulk

<A plastic bag pack>

1. Products are packed into a plastic bag.

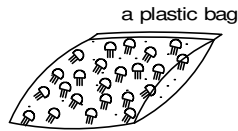

2. The plastic bags are put into a container (corrugated cardboard box) depending on a quantity of an order.

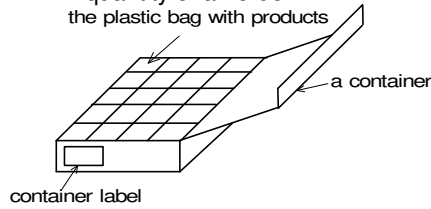

(2) Taping

<An ammo pack>

1. Folding the tape per 25 pitches, products are packed into an ammo package so that each product of each layer wound zigzag is put on top of one another. [Fig 1]
2. The dimensions of the ammo package are indicated in [Fig 2].
3. The ammo packages are put into a container (corrugated cardboard box) depending on a quantity of an order.
4. Not less than 3 consecutive of component shall be missing on both edge of tape. [Fig 1]

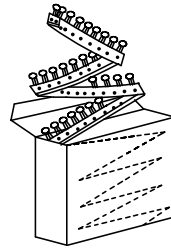

[Fig 2]

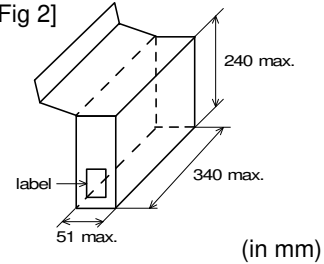

The unloading direction : Right
 The hold down tape : Upper
 The product body : Left along the unloading direction

12. Marking on package

12.1 Unit Package

Bulk : Marked on a plastic bag.

Taping : Marked on a label stuck on an ammo package.

Marking on a unit package consists of :

Customer part number, MURATA part number, Inspection number(*1), RoHS marking (*2), Quantity, etc

*1) « Expression of Inspection No. »

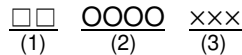

- (1) Factory Code
- (2) Date

First digit : Year / Last digit of year
 Second digit : Month / Jan. to Sep. → 1 to 9, Oct. to Dec. → O,N,D
 Third, Fourth digit : Day

- (3) Serial No.

*2) « Expression of RoHS marking »

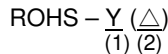

- (1) RoHS regulation conformity parts.
- (2) MURATA classification number

12.2 Container

Marking on the label stuck on a container consists of :

Customer name Purchasing Order Number, Customer Part Number, MURATA part number, RoHS marking (*2), Quantity, etc

13. ⚠ Caution

13.1 Mounting holes

Mounting holes should be designed as specified in this specifications.
 Or different design from this specifications may cause cracks in ceramics which may lead to smoking / firing.

13.2 Terminal Varistor-Capacitor

Products should not be applied for the absorption of surge which have large energy (ex. Included lighting surge, switching surges) because it is designed for the absorption of electrostatic surges.

13.3. Caution for the product angle adjust work

Take care not to apply any mechanical stress to product body at the lead terminal bending process for product angle adjustment after insertion.

13.4 Limitation of Applications

Please contact us before using our products for the applications listed below which require especially high reliability for the prevention of defects which might directly cause damage to the third party's life, body or property.

- | | |
|--|--|
| (1) Aircraft equipment | (7) Traffic signal equipment |
| (2) Aerospace equipment | (8) Disaster prevention / crime prevention equipment |
| (3) Undersea equipment | (9) Data-processing equipment |
| (4) Power plant control equipment | (10) Applications of similar complexity and /or reliability requirements |
| (5) Medical equipment | to the applications listed in the above |
| (6) Transportation equipment (vehicles, trains, ships, etc.) | |

14. Notice

14.1 Soldering

- (1) Use rosin-based flux. Do not use strong acidic flux with halide content exceeding 0.2(wt)% (chlorine conversion value).
 Use Sn-3.0Ag-0.5Cu solder

- (2) Standard flow soldering profile.

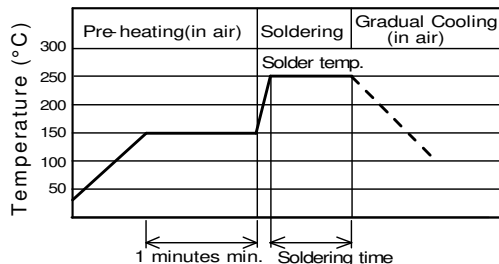

Solder temperature	Soldering time
250~260 °C	4~6s

- (3) Resistance to soldering iron goes in the following condition that tip temperature is 350 °C max. and soldering time is 5s max.
 (4) Products and the leads should not be subject to any mechanical stress during soldering process. (and also while subject to the equivalent high temperature.)

14.2 Cleaning

Avoid Cleaning Product.

14.3 Operating Environment

- (1) Do not use products in corrosive gases such as chlorine gas, acid or sulfide gas.
 (2) Do not use products in the environment where water, oil or organic solvents may adhere to products.
 (3) Do not adhere any resin to products, coat nor mold products with any resin (including adhesive) to prevent mechanical and chemical stress on products.

14.4 Storage and handling requirements

(1) Storage period

Use the products within 12 months after delivered.

Solderability should be checked if this period is exceeded.

(2) Storage environment condition

To prevent products quality deterioration, storage conditions should be controlled as follows ;

1. Temperature : -10 to 40 degrees centigrade

2. Humidity : 15 to 85% relative humidity

3. Products should be stored without sudden changes in temperature and humidity.

Don't keep products in corrosive gases such as sulfur, chlorine gas or acid,
or it may cause oxidization of lead terminals resulting in poor solderability.

4. Products should be stored on the palette for the prevention of the influence from humidity, dust and so on.

5. Products should be stored in the warehouse without heat shock, vibration, direct sunlight and so on.

(3) Handling Conditions

Care should be taken when transporting or handling product to avoid excessive vibration or mechanical shock.

15.  Note

(1) Please make sure that your product has been evaluated in view of your specifications with our product being mounted to your product.

(2) You are requested not to use our product deviating from the reference specifications.

(3) The contents of this reference specification are subject to change without advance notice. Please approve our product specifications or transact the approval sheet for product specifications before ordering.