



Chipsmall Limited consists of a professional team with an average of over 10 year of expertise in the distribution of electronic components. Based in Hongkong, we have already established firm and mutual-benefit business relationships with customers from,Europe,America and south Asia,supplying obsolete and hard-to-find components to meet their specific needs.

With the principle of "Quality Parts,Customers Priority,Honest Operation,and Considerate Service",our business mainly focus on the distribution of electronic components. Line cards we deal with include Microchip,ALPS,ROHM,Xilinx,Pulse,ON,Everlight and Freescale. Main products comprise IC,Modules,Potentiometer,IC Socket,Relay,Connector.Our parts cover such applications as commercial,industrial, and automotives areas.

We are looking forward to setting up business relationship with you and hope to provide you with the best service and solution. Let us make a better world for our industry!



Contact us

Tel: +86-755-8981 8866 Fax: +86-755-8427 6832

Email & Skype: info@chipsmall.com Web: www.chipsmall.com

Address: A1208, Overseas Decoration Building, #122 Zhenhua RD., Futian, Shenzhen, China



**Hybrid IC
 IGBT Gate Driver +
 DC/DC Converter**

Description:

VLA567-01R is a hybrid integrated circuit designed for driving n-channel IGBT modules. This device includes the isolated DC-DC converter required for gate drive.

The built-in short circuit protection provides gate lockout to maintain reverse bias for a predetermined time after the detection of the short circuit.

Features:

- Low Height, DIP Structure
- Built-in Isolated DC-DC Converter for Gate Drive
- Output Peak Current is $\pm 8A$ Max.
- Built-in Short Circuit Protection
- Electrical Isolation Voltage is 2500 Vrms (for 1 Minute)
- CMOS Compatible Input Interface
- Adjustable Fall Time for Short Circuit Protection

Recommended IGBT Modules:

- $V_{CES} = 600V$ up to 600A
- $V_{CES} = 1200V$ up to 600A

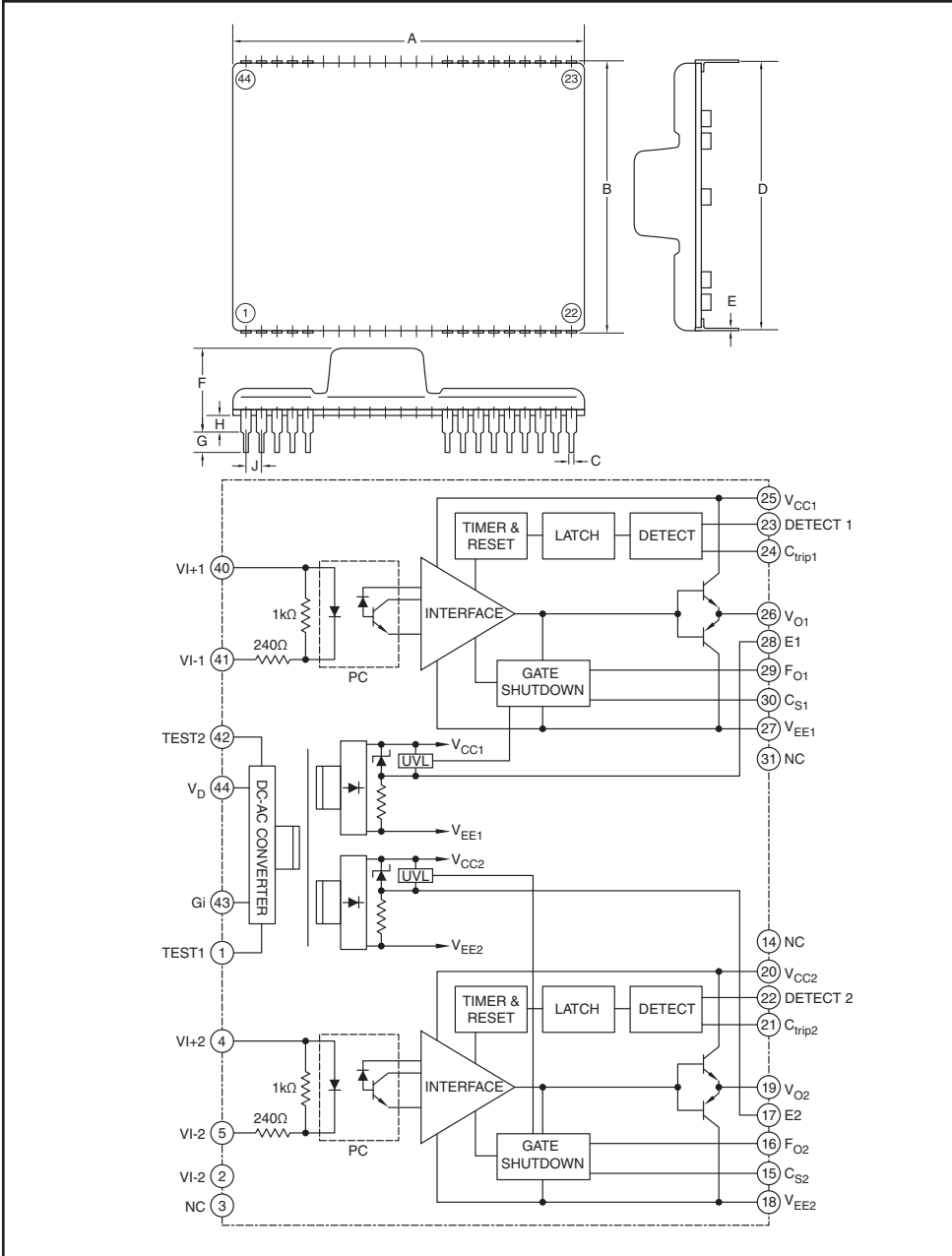

Outline Drawing and Circuit Diagram

Dimensions	Inches	Millimeters
A	2.44 Max.	62.0 Max.
B	1.89 Max.	48.0 Max.
C	0.02±0.0039	0.5±0.1
D	1.8	45.72
E	0.01+0.0067/-0.0039	0.27+0.17/-0.1

Dimensions	Inches	Millimeters
F	0.67 Max.	17.0 Max.
G	0.177±0.06	4.5±1.5
H	0.14	3.5
J	0.1	2.54



Powerex, Inc., 173 Pavilion Lane, Youngwood, Pennsylvania 15697 (724) 925-7272 www.pwr.com

VLA567-01R
Hybrid IC IGBT Gate Driver
+ DC/DC Converter

Absolute Maximum Ratings, $T_a = 25^\circ\text{C}$ unless otherwise specified

Characteristics	Symbol	Rating	Units
Supply Voltage (DC)	V_D	16.5	Volts
Input Signal Voltage (Applied Between VI+ - VI-, 50% Duty Cycle, Pulse Width 1ms)	V_I	-1 ~ +7	Volts
Output Peak Current (Pulse Width 2 μ s)	I_{OHP}	+8	Amperes
	I_{OLP}	-8	Amperes
Operating Temperature (No Condensation Allowable)	T_{opr}	-20 ~ 70	$^\circ\text{C}$
Storage Temperature (No Condensation Allowable)*1	T_{stg}	-40 ~ 90	$^\circ\text{C}$
Fault Output Current (Applied FO-Pin)	I_{FO}	20	mA
Input Voltage at DETECT-pin (Applied DETECT-Pin)	V_{R-DET}	50	Volts
Gate Drive Current (Gate Average Current Per One Circuit)	I_{drive}	100	mA
Isolation Voltage Between Input and Output (Sine Wave Voltage, 60Hz for 1 Minute)	V_{iso1}	2500	V_{rms}
Isolation Voltage Between Each Onput (Sine Wave Voltage, 60Hz for 1 Minute)	V_{iso2}	2500	V_{rms}

*1 Differs from H/C condition.

VLA567-01R
Hybrid IC IGBT Gate Driver
+ DC/DC Converter

Electrical Characteristics, $T_a = 25^\circ\text{C}$, $V_D = 15\text{V}$, $R_G = 2\Omega$ unless otherwise specified

Characteristics	Symbol	Test Conditions	Min.	Typ.	Max.	Units
Supply Voltage	V_D	Recommended Range	14.2	15.0	15.8	Volts
Pull-up Voltage on Input Side	V_{IN}	Recommended Range, (When $V_{IN} = 15\text{V}$, "H" Input Current Must Stay in Recommended Range)	4.75	5.00	5.25	Volts
"H" Input Signal Current ^{*3}	I_{IH}	Recommended Range	10	13	16	mA
Switching Frequency	f	Recommended Range	—	—	20	kHz
Gate Resistance	R_G	Recommended Range	2	—	—	Ω
Gate Positive Supply Voltage	V_{CC}		—	16.8	—	Volts
Gate Negative Supply Voltage	V_{EE}		—	-8.5	—	Volts
Gate Supply Efficiency	η	$V_D = 15\text{V}$, Load Current = 100mA x 2	70	79	—	%
"H" Output Voltage ^{*3}	V_{OH}	$R_G = 2\Omega$, f = 10kHz, Load Current = 0.22 μF	13.5	15.5	16.5	Volts
"L" Output Voltage ^{*3}	V_{OL}	$R_G = 2\Omega$, f = 10kHz, Load Current = 0.22 μF	—	-8.0	—	Volts
"L-H" Propagation Time ^{*3}	t_{PLH}	$I_{IH} = 13\text{mA}$	0.2	0.4	1	μs
"L-H" Rise Time ^{*3}	t_r	$I_{IH} = 13\text{mA}$	—	0.4	1	μs
"H-L" Propagation Time ^{*3}	t_{PHL}	$I_{IH} = 13\text{mA}$	0.2	0.4	1	μs
"H-L" Fall Time ^{*3}	t_f	$I_{IH} = 13\text{mA}$	—	0.3	1	μs
Timer	t_{timer}	Between Start and Cancel (Under Input Sign "L")	1	—	2	ms
Fault Output Current	I_{FO}	Applied Pin 16, 29 ^{*4}	—	5	—	mA
Controlled Time Detect Short Circuit 1	t_{trip1}	Pin 22, 23 : 15V or More, Pin 21, 24 : Open	—	2.4	—	μs
Controlled Time Detect Short Circuit 2 ^{*2}	t_{trip2}	Pin 22, 23 : 15V and More, Pin 17-21, 24-28 : 47pF	—	3.2	—	μs
SC Detect Voltage	V_{SC}	Collector Voltage of Module	15	—	—	Volts
Under Voltage Lock Out	UVLO_ V_{CC}	Voltage of V_{CC}	—	11.5	—	Volts

*2 Length of wiring of condenser controlled time detect short-circuit is within 5cm from Pin 17 and 21 (24 and 28) coming and going.

*3 When LED of PC is ON (luminescence), V_O is high.

*4 With pull-up 4.7k ohm.

VLA567-01R
Hybrid IC IGBT Gate Driver
+ DC/DC Converter

Definition of Characteristics

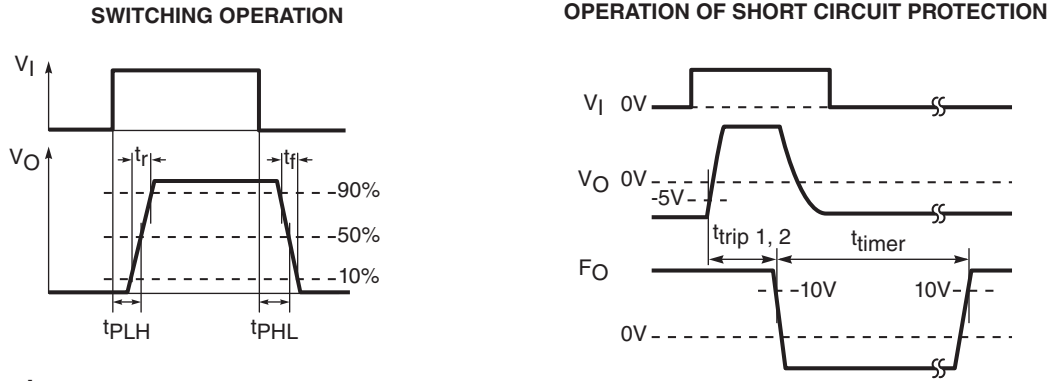

Application Example

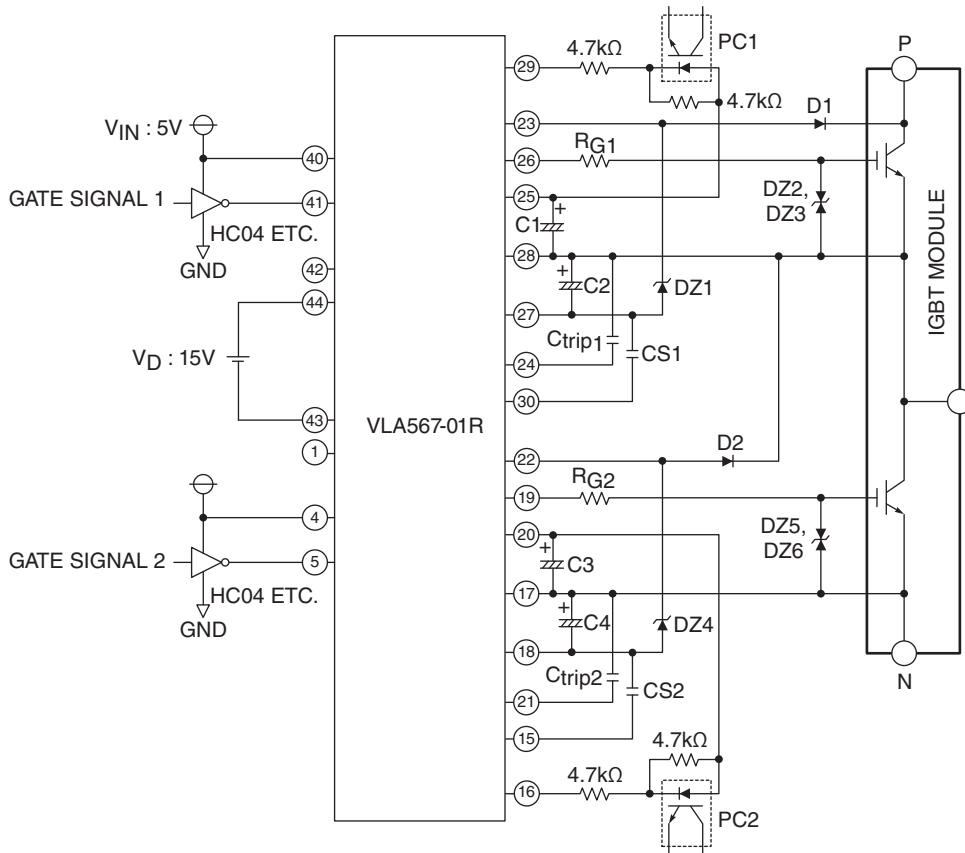

NOTE:

1. Low impedance capacitors (C1~C4) should be connected as close as possible to the hybrid IC.
2. D1 requires approximately the same blocking voltage as the power modules.
3. If the reverse recovery time of D1 or D2 is long, Pin 22 or Pin 23 can end up with high voltage. For additional protection, insert a zener diode between Pin 18 and Pin 22 as well as between Pin 23 and Pin 27 as shown in the application example circuit.
4. If using an external C_{trip} capacitor at Pin 21 or Pin 24, the C_{trip} must be wired as close as possible to the IC's pins (less than 5cm total).
5. The wiring length from the driver's output to the IGBT's gate should be kept as short as possible, as should the signal connections from the controller to the driver's inputs in order to avoid errors caused by circuit noise.
6. A 4.7k Ω resistor can be connected between Pins 17 and 22 as well as between Pins 23 and 28 if short-circuit protection is not desired. In this case D1, D2, DZ1 and DZ4 should be left out and Pins 16 and 29 should be left unconnected.
7. Pins 1 and 42 are for manufacturing test purposes, and should be left unconnected.

- $V_D = 15V \pm 5\%$
 $V_{IN} = 5V \pm 5\%$
 C1 ~ 4 = 100 μ F, 50V (Low Impedance)
 C_{trip1} , C_{trip2} : Depended on R_{G1} , R_{G2}
 (Aim : 0 ~ 47pF, 40V, Ceramic)
 $CS1$, $CS2$: Depends on Serge Voltage
 Z1, Z4 : 30V
 DZ2, DZ3, DZ5, DZ6 : 18V
 D1, D2 : Fast Recovery Diode (t_{rr} : 0.2 μ s max.) RP1H(Sanken) etc.
 PC1, PC2 : TLP781(Toshiba), PS2501 (NEC) etc.

VLA567-01R
Hybrid IC IGBT Gate Driver
+ DC/DC Converter

Operation of Protection Circuit

1. When an "ON" input signal is applied for a period longer than T_{trip} and the collector voltage is high, the hybrid IC will recognize the condition as a short-circuit and immediately reduce the gate voltage. It will also produce a low voltage fault signal at the respective Pin 29 or Pin 16 alerting that the protection circuit is in operation.
2. The protection circuit will reset if an "OFF" input signal is applied and the minimum 1~2ms shutdown time has passed. "OFF" signal must be $10\mu s$ or more.
3. The controlled time to detect a short-circuit (T_{trip}) should be set so that the IGBT can be fully turned "ON" before a short-circuit condition can be detected. It is possible to adjust T_{trip} by connecting a capacitor (C_{trip}) between Pins 17 and 21, as well as Pins 28 and 24.
4. When the short-circuit protection is activated, the soft gate shutdown circuit reduces the collector surge voltage on the IGBT. The gate shut down speed can be slowed even more by adding a capacitor to the C_S terminal (between Pins 15 and 18; Pins 27 and 30).

Adjustment of Output Fall Time

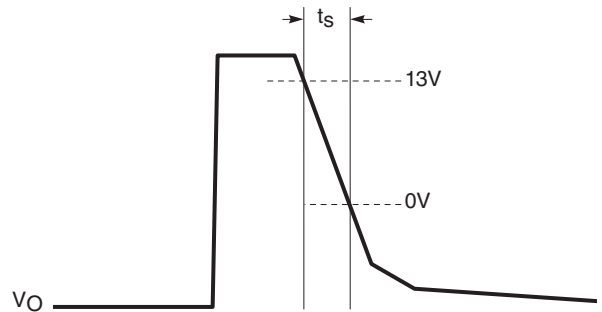

Operation Flow on Detecting Short Circuit

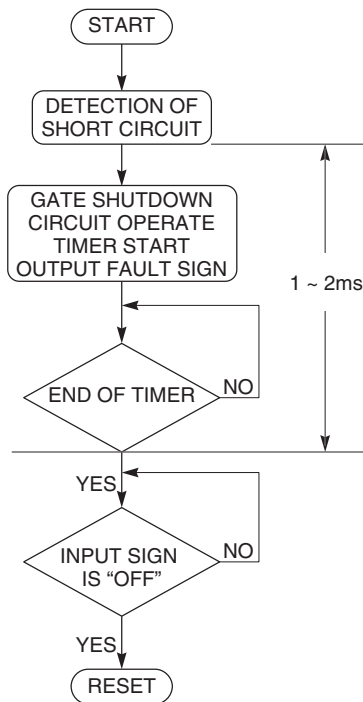

NOTE: "L" output voltage (VOL) with protection circuit operating is about $V_{EE} + 2V$

$t_s - C_S$ CHARACTERISTICS (TYPICAL)

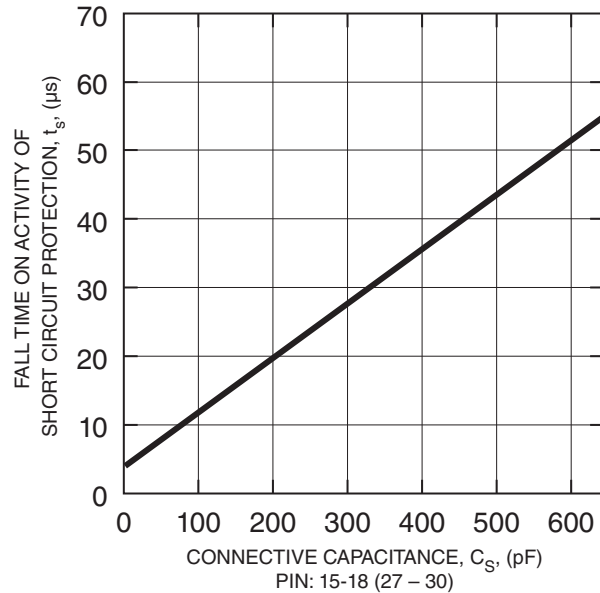

VLA567-01R
Hybrid IC IGBT Gate Driver
+ DC/DC Converter

V_{CC} , $|V_{EE}|$ CHARACTERISTICS (TYPICAL)

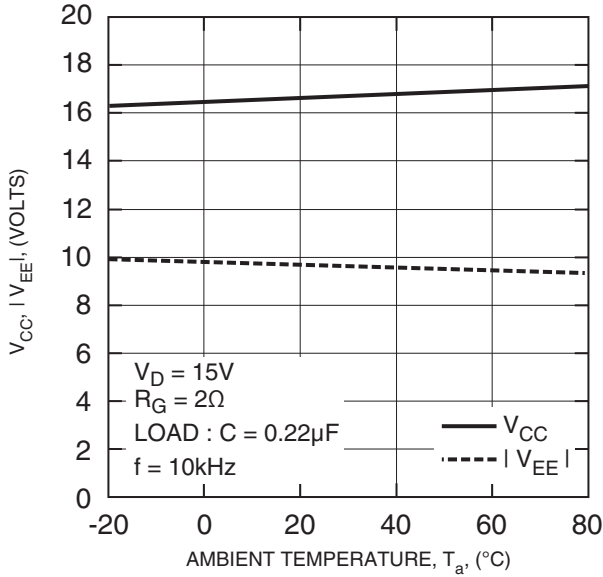

V_{CC} , $|V_{EE}|$ - I_O CHARACTERISTICS (TYPICAL)

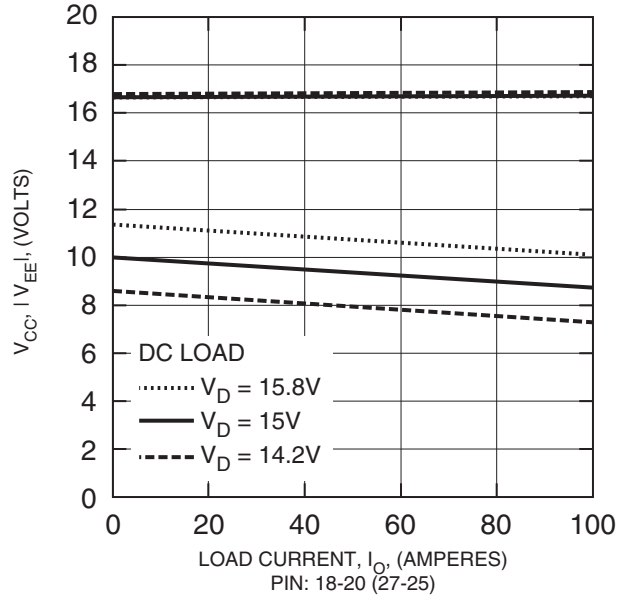

t_{PLH} , t_{PHL} - T_a CHARACTERISTICS (TYPICAL)

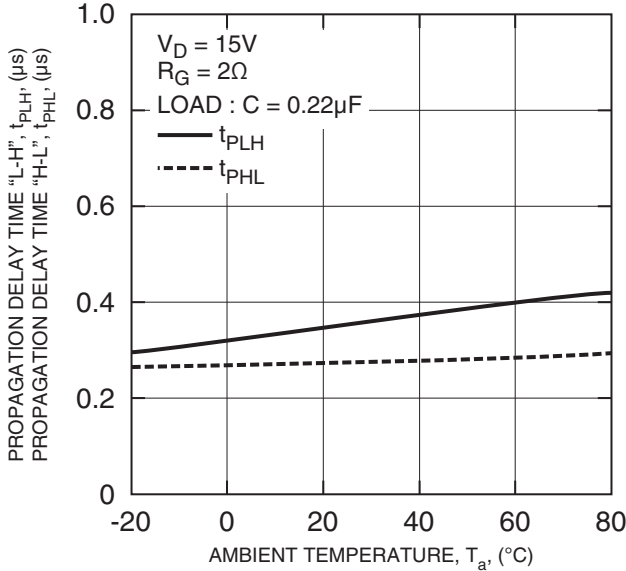

t_{PLH} , t_{PHL} - V_I CHARACTERISTICS (TYPICAL)

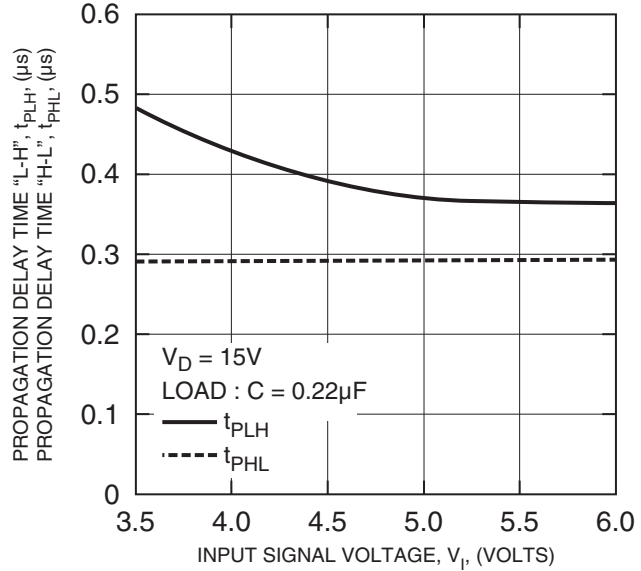

VLA567-01R
Hybrid IC IGBT Gate Driver
+ DC/DC Converter

t_{trip} - T_a CHARACTERISTICS (TYPICAL)

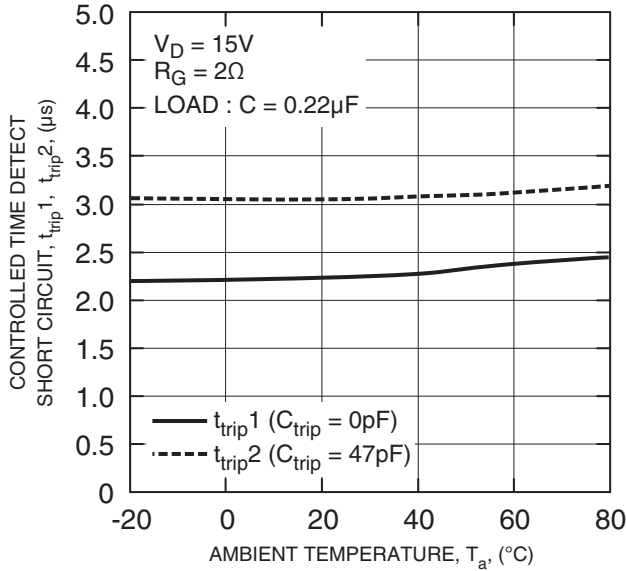

t_{trip} - C_{trip} CHARACTERISTICS (TYPICAL)

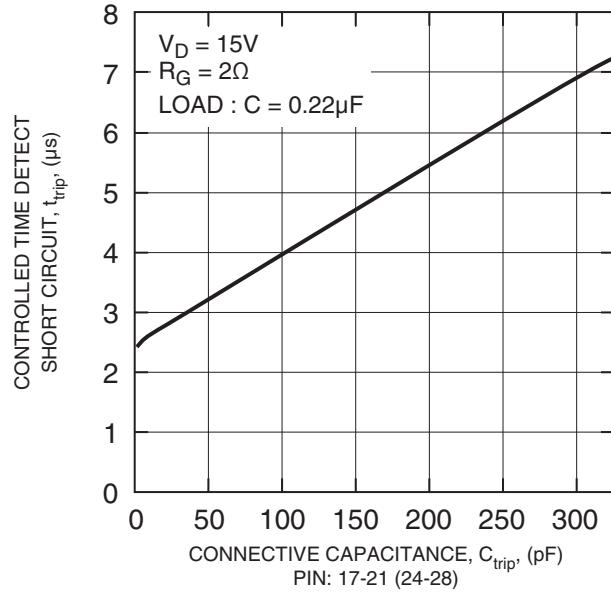

I_D - I_O CHARACTERISTICS (TYPICAL)

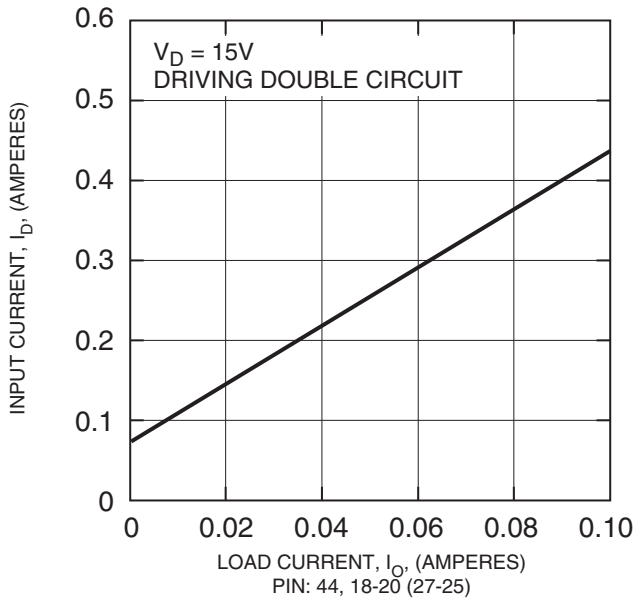

V_{OH} , V_{OL} - T_a CHARACTERISTICS (TYPICAL)

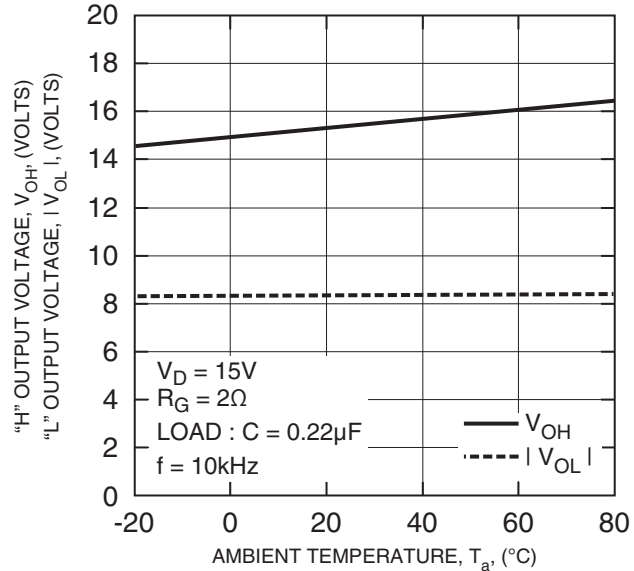

VLA567-01R
Hybrid IC IGBT Gate Driver
+ DC/DC Converter

η - I_{drive} CHARACTERISTICS (TYPICAL)

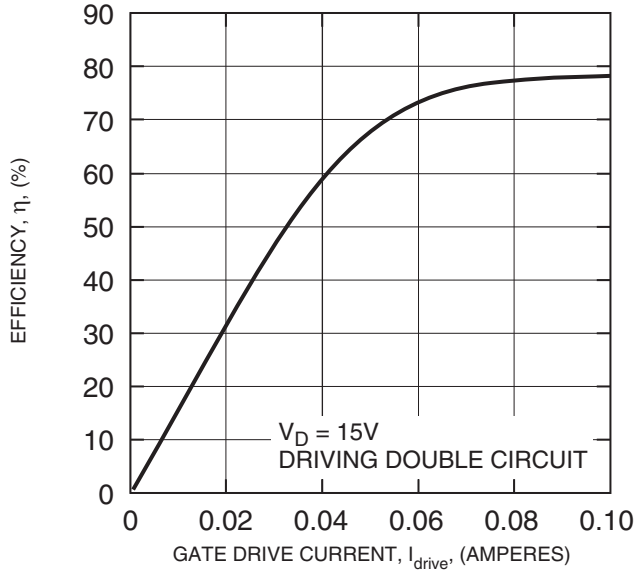

V_{CC} , $|V_{EE}|$ - V_D CHARACTERISTICS (TYPICAL)

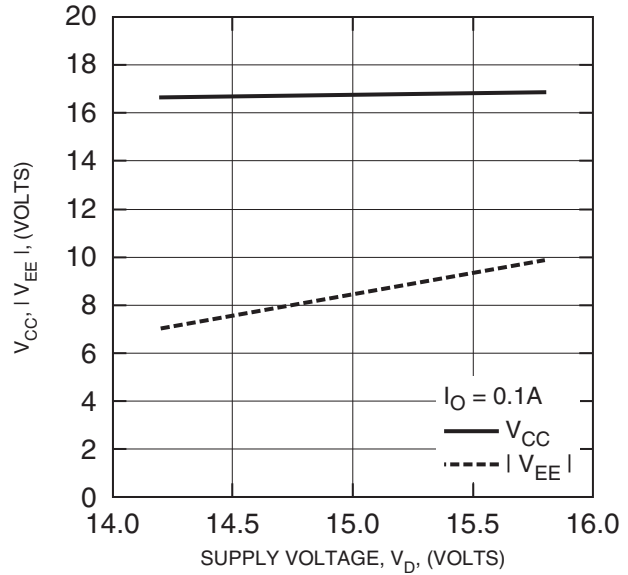

DERATING CHARACTERISTICS (TYPICAL)

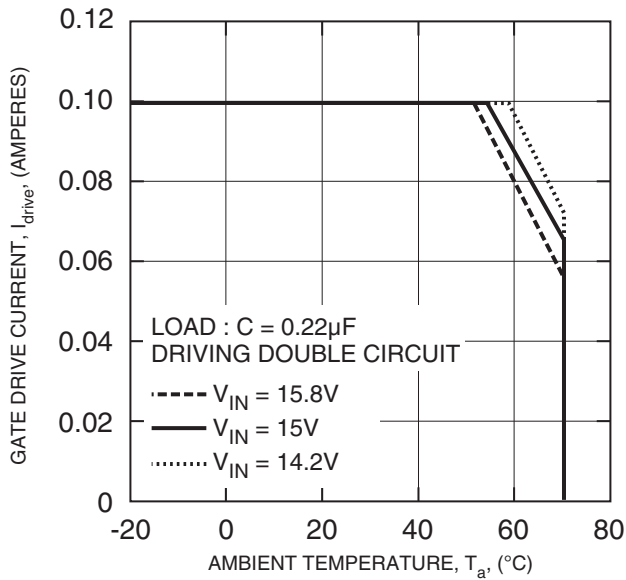

η - V_D CHARACTERISTICS (TYPICAL)

