



Chipsmall Limited consists of a professional team with an average of over 10 year of expertise in the distribution of electronic components. Based in Hongkong, we have already established firm and mutual-benefit business relationships with customers from,Europe,America and south Asia,supplying obsolete and hard-to-find components to meet their specific needs.

With the principle of “Quality Parts,Customers Priority,Honest Operation,and Considerate Service”,our business mainly focus on the distribution of electronic components. Line cards we deal with include Microchip,ALPS,ROHM,Xilinx,Pulse,ON,Everlight and Freescale. Main products comprise IC,Modules,Potentiometer,IC Socket,Relay,Connector.Our parts cover such applications as commercial,industrial, and automotives areas.

We are looking forward to setting up business relationship with you and hope to provide you with the best service and solution. Let us make a better world for our industry!



Contact us

Tel: +86-755-8981 8866 Fax: +86-755-8427 6832

Email & Skype: info@chipsmall.com Web: www.chipsmall.com

Address: A1208, Overseas Decoration Building, #122 Zhenhua RD., Futian, Shenzhen, China



POLYSWITCH RESETTABLE DEVICES

Strap Battery Devices

Littelfuse PolySwitch, a pioneer of polymeric positive temperature coefficient (PPTC) resettable devices, offers several material platforms to help protect battery applications. Each of these material platforms offers different performance characteristics that allow the engineer greater design flexibility. PolySwitch devices for battery protection include SRP, LR4, VTP, VLP, VLR, MXP and MGP series, disc and special application strap devices.

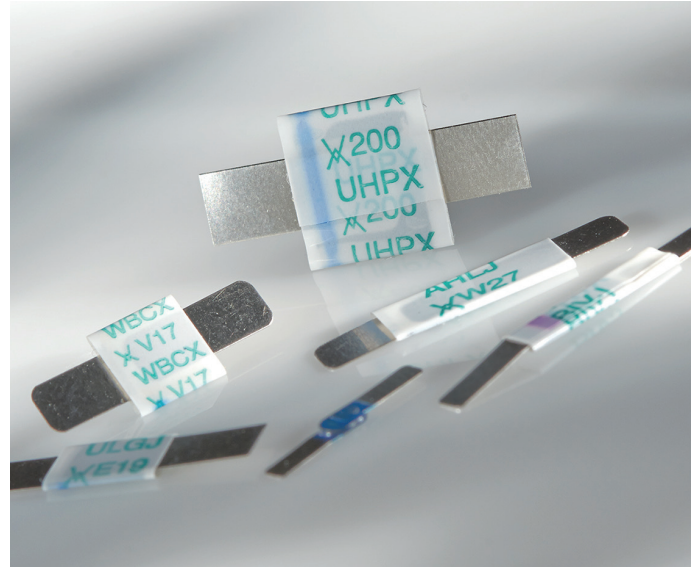

BENEFITS

- Many material platforms and device form factors help provide engineers more design flexibility
- Compatible with high-volume electronics assembly
- Assists in meeting regulatory requirements
- Low-resistance devices increase battery operating time

FEATURES

- RoHS compliant
- Lead-free versions of all devices are available
- Broad range of resettable devices available
- Current ratings from 1.1A to 13A
- Voltage ratings from 6V to 30V
- Agency recognition: UL, CSA, TÜV
- Fast time-to-trip
- Low resistance

APPLICATIONS

- Mobile phone and smart phone battery packs
- Tablet PC battery packs
- Mobile radio battery packs
- Computer battery packs
- Digital camera battery packs
- Portable media player battery packs
- Power tools (charge line)

PolySwitch Resettable Devices

Strap Battery Devices

Application Selection Guide

The guide below lists PolySwitch strap battery devices which are typically used in applications.

The following pages contain the specifications for the part numbers recommended below.

Once a device is selected, the user should evaluate and test each product for its intended application.

Protection Application	Additional Comments	PolySwitch Resettable Devices — Key Device Selection Criteria		
		Installation Method	Lowest Resistance	Lowest Thermal Cut-off
Mobile Phone Battery Packs	Li-ion	Surface-mount	Refer to Surface-mount Section of this Catalog	
		Prismatic	MXP370BD	VLR175F
Cordless Phone Battery Packs	NiMH	Cylindrical	VLP210F	—
			SRP175F	
Mobile Radio Battery Packs	NiMH	Cylindrical	LR4-380F	—
			SRP350F	
Computer Battery Packs	NiMH	Cylindrical	LR4-900F	—
	Li-ion	Cylindrical	LR4-1300SSF	—
		Prismatic	Consult Local Rep	Consult Local Rep
Camcorder Battery Packs	NiMH or Li-ion	Prismatic	VLP270F	VTP210GF
			LR4-380F	—
PDA Battery Packs	Li-ion	Prismatic	VLP220F	VLR175F
Power Tools (Charge Line)	NiCd, NiMH or Li-ion	Cylindrical	Custom LR4	Custom VTP

Table B1 — Product Series - Current Rating, Voltage Rating / Typical Resistance

Hold Current (A)	VLR	VLP	VTP	MXP	SRP	LR4
	Typical Activation Temperature					
	85°C	90°C	90°C	120°C	125°C	125°C
1.10	—	—	16V/0.054Ω	—	—	—
1.20	—	16V/0.053Ω	—	—	15V/0.123Ω	—
1.70	12V/0.025Ω	—	16V/0.041Ω	—	—	—
1.75	12V/0.024Ω	16V/0.032Ω	16V/0.040Ω	—	15V/0.070Ω	—
1.80	—	—	—	6V/0.0105Ω	—	—
1.90	—	—	—	6V/0.011Ω	—	15V/0.056Ω
2.00	—	—	—	—	30V/0.045Ω	—
2.10	—	16V/0.024Ω	16V/0.024Ω	—	—	—
2.20	—	16V/0.023Ω	—	—	—	—
2.30	12V/0.015Ω	—	—	—	—	—
2.50	—	—	—	6V/0.011Ω	—	—
2.60	—	—	—	—	—	15V/0.031Ω
2.70	—	16V/0.015Ω	—	6V/0.0105Ω	—	—
3.10	—	—	—	6V/0.0075Ω	—	—
3.50	—	—	—	—	30V/0.024Ω	—
3.70	—	—	—	6V/0.007Ω	—	—
3.80	—	—	—	—	—	15V/0.020Ω
4.20	—	—	—	—	30V/0.018Ω	—
4.50	—	—	—	—	—	20V/0.016Ω
5.50	—	—	—	—	—	20V/0.013Ω
6.00	—	—	—	—	—	20V/0.011Ω
7.30	—	—	—	—	—	20V/0.009Ω
9.00	—	—	—	—	—	20V/0.008Ω
13.00	—	—	—	—	—	20V/0.006Ω

PolySwitch Resettable Devices

Strap Battery Devices

Table B2 – Thermal Derating [Hold Current (A) at Ambient Temperature (°C)]

Part Number	Maximum Ambient Temperature												
	-40°C A	-20°C	0°C	20°C	25°C	40°C	50°C	60°C	70°C	80°C	85°C		
85°C Typical Activation													
VLR*													
VLR170F	3.5	2.9	2.4	1.84	1.70	1.2	1.0	0.7	0.3	—	—		
VLR175F	3.5	2.9	2.4	1.87	1.75	1.3	1.0	0.8	0.3	—	—		
VLR175LF	3.5	2.9	2.4	1.87	1.75	1.3	1.0	0.8	0.3	—	—		
VLR230F	5.0	4.2	3.4	2.52	2.30	1.7	1.3	0.9	0.4	—	—		
90°C Typical Activation													
VLP*													
VLP120UF	2.4	2.1	1.8	1.30	1.20	1.0	0.7	0.6	0.3	0.2	0.1		
VLP175UAF	3.2	2.7	2.3	1.70	1.75	1.2	1.0	0.9	0.5	0.2	0.1		
VLP210F	4.3	3.6	2.9	2.31	2.10	1.6	1.3	1.0	0.6	0.3	0.1		
VLP220F	4.5	3.8	3.0	2.45	2.20	1.7	1.4	1.1	0.7	0.3	0.1		
VLP270F	5.6	4.7	4.0	3.05	2.70	2.2	1.7	1.4	0.9	0.4	0.1		
VTP*													
VTP110F	2.0	1.7	1.4	1.12	1.10	0.85	0.75	0.7	0.4	0.2	0.1		
VTP170F	3.2	2.7	2.2	1.80	1.70	1.3	1.0	0.8	0.5	0.3	0.1		
VTP170XSF	3.2	2.7	2.2	1.80	1.70	1.3	1.0	0.8	0.5	0.3	0.1		
VTP175F	3.2	2.7	2.2	1.84	1.75	1.3	1.0	0.8	0.5	0.3	0.1		
VTP175LF	3.2	2.7	2.2	1.84	1.75	1.3	1.0	0.8	0.5	0.3	0.1		
VTP210GF	4.1	3.5	2.9	2.26	2.10	1.6	1.3	1.0	0.7	0.4	0.1		
VTP210SF	4.1	3.5	2.9	2.26	2.10	1.6	1.3	1.0	0.7	0.4	0.1		
Part Number	Maximum Ambient Temperature												
	-40°C A	-20°C	0°C	20°C	25°C	40°C	50°C	60°C	70°C	75°C	80°C	85°C	90°C
120°C Typical Activation													
MXP*													
MXP180	—	—	2.45	—	1.8	—	—	0.80	—	—	—	—	—
MXP190BB	—	—	2.6	—	1.9	—	—	0.85	—	—	—	—	—
MXP250K	—	—	3.6	—	2.5	—	—	1.3	—	—	—	—	—
MXP270	—	—	3.8	—	2.7	—	—	1.4	—	—	—	—	0.3
MXP310	—	—	5.0	—	3.1	—	—	1.9	—	1.0	—	—	—
MXP370BD	—	—	5.0	—	3.7	—	—	1.9	—	—	—	—	—
120°C Typical Activation													
MGP													
MGP450	—	—	—	—	4.5	—	—	2.6	—	—	—	—	—
MGP500	—	—	—	—	5.0	—	—	3.0	2.0	—	—	—	—
Part Number	Maximum Ambient Temperature												
	-40°C A	-20°C	0°C	20°C	25°C	40°C	50°C	60°C	70°C	80°C	85°C		
125°C Typical Activation													
SRP													
SRP120F	1.9	1.7	1.5	1.20	1.17	1.0	0.9	0.8	0.6	0.5	0.4		
SRP175F	2.5	2.2	2.0	1.75	1.68	1.4	1.3	1.2	1.0	0.9	0.8		
SRP200F	3.1	2.8	2.5	2.00	1.97	1.7	1.5	1.4	1.2	1.0	0.9		
SRP350F	5.3	4.8	4.3	3.50	3.44	3.0	2.7	2.5	2.1	1.8	1.7		
SRP420F	6.3	5.7	5.1	4.20	4.11	3.6	3.3	3.0	2.6	2.2	2.1		
LR4													
LR4-190F	2.8	2.5	2.3	1.9	1.86	1.6	1.5	1.4	1.2	1.1	1.0		
LR4-260F	3.8	3.4	3.1	2.6	2.54	2.2	2.0	1.9	1.7	1.4	1.3		
LR4-380F	5.4	4.9	4.4	3.8	3.64	3.3	3.0	2.8	2.5	2.3	2.1		
LR4-380XF	5.4	4.9	4.4	3.8	3.64	3.3	3.0	2.8	2.5	2.3	2.1		
LR4-450F	6.5	5.8	5.3	4.5	4.38	3.9	3.6	3.3	2.9	2.6	2.4		
LR4-550F	7.6	6.9	6.2	5.5	5.32	4.7	4.3	4.0	3.6	3.2	3.0		
LR4-600F	8.7	7.8	7.1	6.0	5.86	5.2	4.7	4.4	3.9	3.4	3.2		
LR4-600XF	8.7	7.8	7.1	6.0	5.86	5.2	4.7	4.4	3.9	3.4	3.2		
LR4-730F	10.5	9.5	8.6	7.3	7.13	6.3	5.7	5.4	4.7	4.2	4.0		
LR4-900F	12.7	11.4	10.0	9.0	8.50	7.5	6.8	6.2	5.5	4.9	4.5		
LR4-1300SSF	17.9	16.2	14.5	13.0	12.40	11.1	10.3	9.5	8.6	7.7	7.2		

* Product electrical characteristics determined at 25°C.

PolySwitch Resettable Devices

Strap Battery Devices

Figure B1 – Thermal Derating Curve

- A = LR4
- B = SRP
- C = VTP, VLP, MXP
- D = MGP
- E = VLR
- F = RSD

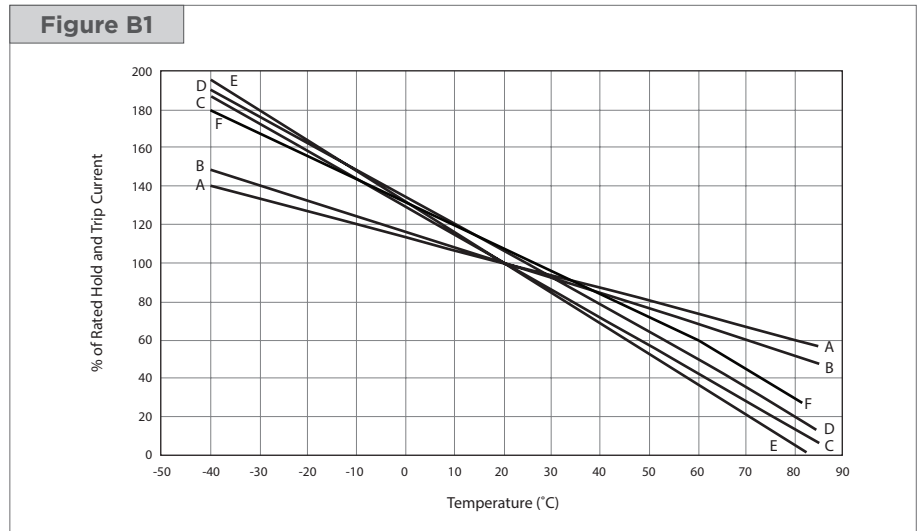

Table B3 – Electrical Characteristics

Part Number	I _H (A)	I _T (A)	V _{MAX} (V _{DC})	I _{MAX} (A)	P _{D MAX} (W)	Max Time-to-trip		R _{MIN} (Ω)	R _{MAX} (Ω)	R _{1MAX} (Ω)	Figure for Dimension
						(A)	(s)				
85°C Typical Activation											
VLR*											
VLR170F	1.70	4.1	12	100	1.4	8.50	5.0	0.018	0.032	0.064	B3
VLR175F	1.75	4.2	12	100	1.4	8.75	5.0	0.017	0.031	0.062	B3
VLR175LF	1.75	4.2	12	100	1.4	8.75	5.0	0.017	0.031	0.062	B3
VLR230F	2.30	5.0	12	100	2.5	10.00	5.0	0.012	0.018	0.036	B3
90°C Typical Activation											
VLP*											
VLP120UF	1.20	3.6	16	60	1.6	7.00	5.0	0.039	0.067	0.134	B5
VLP175UAF	1.75	3.9	16	60	1.8	8.75	5.0	0.023	0.041	0.082	B5
VLP210F	2.10	5.0	16	60	1.8	10.50	5.0	0.018	0.030	0.060	B2
VLP220F	2.20	5.3	16	60	1.8	11.00	5.0	0.017	0.029	0.058	B3
VLP270F	2.70	6.5	16	60	2.5	13.50	5.0	0.012	0.018	0.036	B3
VTP*											
VTP110F	1.10	2.7	16	100	1.3	5.50	5.0	0.038	0.070	0.140	B5
VTP170F	1.70	3.4	16	100	1.4	8.50	5.0	0.030	0.052	0.105	B2
VTP170XSF	1.70	3.4	16	100	1.4	8.50	5.0	0.030	0.052	0.105	B4
VTP175F	1.75	3.6	16	100	1.4	8.75	5.0	0.029	0.051	0.102	B3
VTP175LF	1.75	3.6	16	100	1.4	8.75	5.0	0.029	0.051	0.102	B3
VTP210GF	2.10	4.7	16	100	1.5	10.00	5.0	0.018	0.030	0.060	B3
VTP210SF	2.10	4.7	16	100	1.5	10.00	5.0	0.018	0.030	0.060	B4
120°C Typical Activation											
MXP*											
MXP180	1.80	5.2	6	50	1.0	9.00	5.0	0.007	0.014	0.024	B10
MXP190BB	1.90	4.9	6	50	1.0	9.50	2.0	0.007	0.015	0.024	B9
MXP250K	2.50	6.2	6	50	1.0	13.50	2.0	0.006	0.016	0.028	B10
MXP270	2.70	6.2	6	50	1.0	13.50	2.0	0.006	0.015	0.026	B10
MXP310	3.10	9.0	6	50	1.3	17.50	5.0	0.003	0.012	0.018	B10
MXP370BD	3.70	9.0	6	50	1.3	18.50	5.0	0.004	0.010	0.016	B10

* Product electrical characteristics determined at 25°C.

PolySwitch Resettable Devices

Strap Battery Devices

Table B3 – Electrical Characteristics

(Cont'd)

Part Number	I_H (A)	I_T (A)	V_{MAX} (V _{DC})	I_{MAX} (A)	$P_{D MAX}$ (W)	Max Time-to-trip		R_{MIN} (Ω)	R_{MAX} (Ω)	R_{1MAX} (Ω)	Figure for Dimension
						(A)	(s)				
120°C Typical Activation											
MGP											
MGP450	4.50	9.2	6	50	1.5	25.00	5.0	0.0025	0.007	0.013	B11
MGP500	5.00	9.2	6	50	1.5	25.00	5.0	0.0025	0.0065	0.013	B12
125°C Typical Activation											
SRP											
SRP120F	1.20	2.7	15	100	1.2	6.00	5.0	0.085	0.160	0.220	B6
SRP175F	1.75	3.8	15	100	1.5	8.75	5.0	0.050	0.090	0.120	B6
SRP200F	2.00	4.4	30	100	1.9	10.00	4.0	0.030	0.060	0.100	B6
SRP350F	3.50	6.3	30	100	2.5	20.00	3.0	0.017	0.031	0.050	B6
SRP420F	4.20	7.6	30	100	2.9	20.00	6.0	0.012	0.024	0.040	B6
LR4											
LR4-190F	1.90	3.9	15	100	1.2	9.5	5.0	0.0390	0.0720	0.102	B7
LR4-260F	2.60	5.8	15	100	2.5	13.0	5.0	0.0200	0.0420	0.063	B7
LR4-380F	3.80	8.3	15	100	2.5	19.0	5.0	0.0130	0.0260	0.037	B7
LR4-380XF	3.80	8.3	15	100	2.5	19.0	5.0	0.0130	0.0260	0.037	B7
LR4-450F	4.50	8.9	20	100	2.3	22.5	5.0	0.0110	0.0200	0.028	B7
LR4-550F	5.50	10.5	20	100	2.8	27.5	5.0	0.0090	0.0160	0.022	B7
LR4-600F	6.00	11.7	20	100	2.8	30.0	5.0	0.0070	0.0140	0.019	B7
LR4-600XF	6.00	11.7	20	100	2.8	30.0	5.0	0.0075	0.0140	0.019	B7
LR4-730F	7.30	14.1	20	100	3.3	30.0	5.0	0.0060	0.0120	0.015	B7
LR4-900F	9.00	16.7	20	100	3.8	45.0	5.0	0.0060	0.0100	0.014	B7
LR4-1300SSF	13.00	21.2	20	100	4.5	50.0	10.0	0.0035	0.0065	0.009	B8

* Product electrical characteristics determined at 25°C.

Notes

- I_H : Hold current: maximum current device will pass without interruption in 20°C still air unless otherwise specified.
- I_T : Trip current: minimum current that will switch the device from low-resistance to high-resistance in 20°C still air unless otherwise specified.
- V_{MAX} : Maximum voltage device can withstand without damage at rated current.
- I_{MAX} : Maximum fault current device can withstand without damage at rated voltage.
- P_D : Power dissipated from device when in the tripped state in 20°C still air unless otherwise specified.
- R_{MIN} : Minimum resistance of device as supplied at 20°C unless otherwise specified.
- R_{MAX} : Maximum resistance of device as supplied at 20°C unless otherwise specified.
- R_{1MAX} : Maximum resistance, measured at 20°C unless otherwise specified, of device one hour after being tripped the first time.

Figures B2-B12 – Dimension Figures

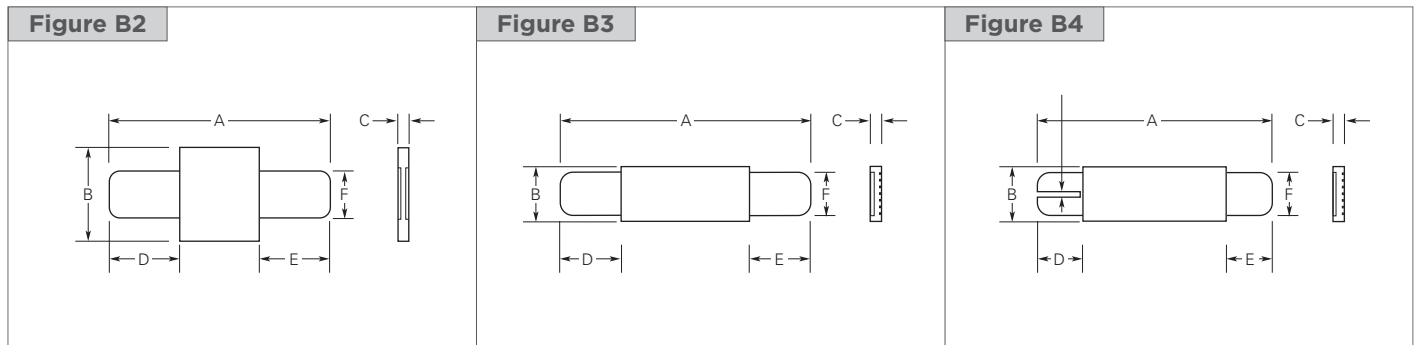

PolySwitch Resettable Devices

Strap Battery Devices

Figures B2-B12 – Dimension Figures

(Cont'd)

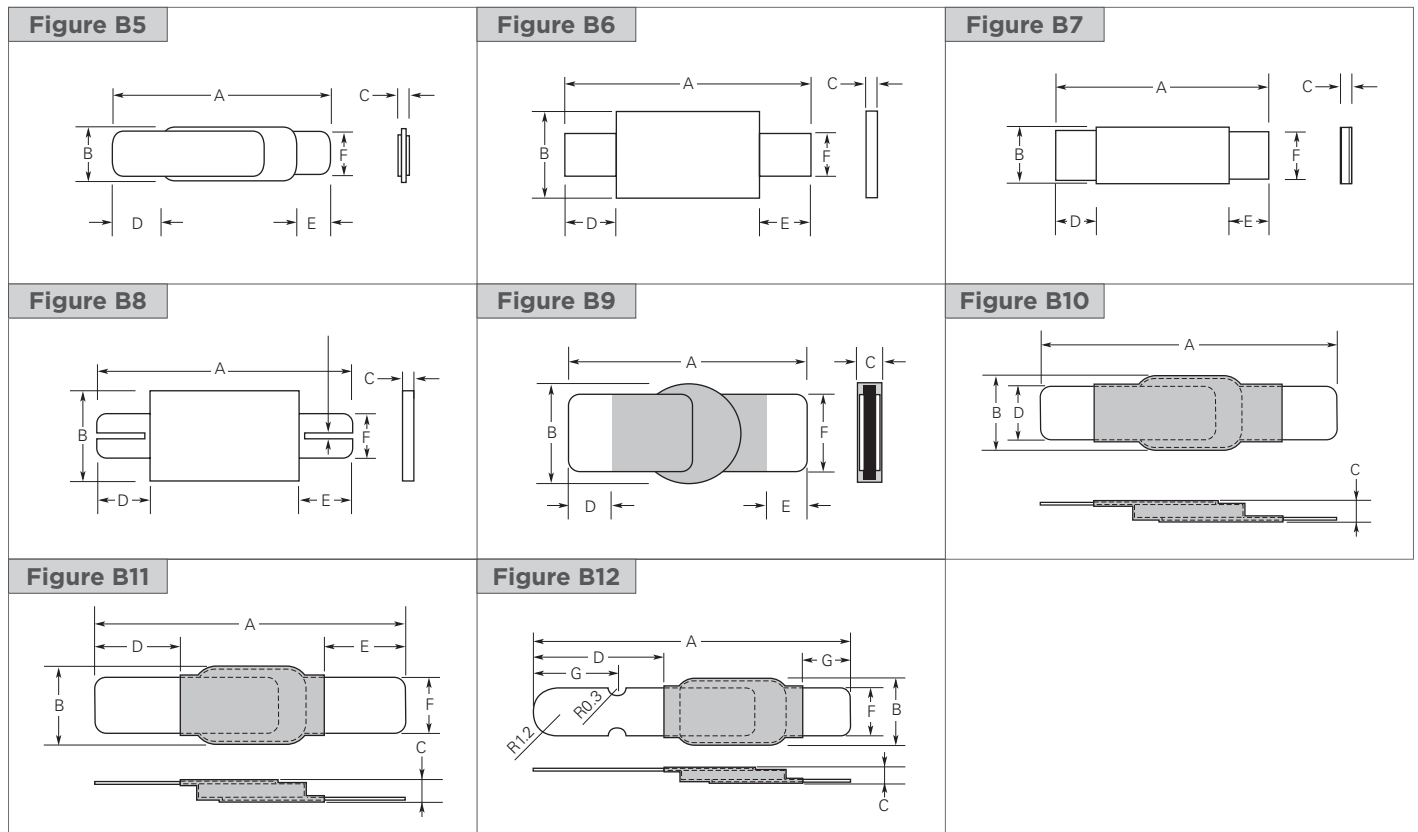

Table B4 – Dimensions in Millimeters (Inches)

Part Number	A		B		C		D		E		F		G		Figure
	Min	Max	Min	Max	Min	Max	Min	Max	Min	Max	Min	Max	Min	Max	
85°C Typical Activation															
VLR															
VLR170F	20.8 (0.832)	23.2 (0.928)	3.5 (0.140)	3.9 (0.156)	—	0.8 (0.032)	4.5 (0.180)	6.5 (0.260)	4.5 (0.180)	6.5 (0.260)	2.4 (0.096)	2.6 (0.104)	—	—	B3
VLR175F	23.0 (0.920)	24.5 (0.980)	2.9 (0.116)	3.3 (0.132)	0.5 (0.020)	0.8 (0.032)	4.7 (0.188)	7.2 (0.288)	3.8 (0.152)	5.4 (0.216)	2.4 (0.096)	2.6 (0.104)	—	—	B3
VLR175LF	29.3 (1.172)	31.7 (1.268)	2.9 (0.116)	3.3 (0.132)	—	0.8 (0.032)	5.2 (0.208)	6.8 (0.272)	10 (0.400)	12.5 (0.500)	2.4 (0.096)	2.6 (0.104)	—	—	B3
VLR230F	20.9 (0.836)	23.1 (0.924)	4.9 (0.196)	5.3 (0.212)	—	0.8 (0.032)	4.1 (0.164)	5.8 (0.232)	4.1 (0.164)	5.8 (0.232)	3.9 (0.156)	4.1 (0.164)	—	—	B3
90°C Typical Activation															
VLP															
VLP120UF	10.9 (0.430)	11.8 (0.460)	4.4 (0.170)	4.6 (0.180)	—	0.7 (0.028)	5.5 (0.220)	6.5 (0.260)	1.65 (0.065)	1.9 (0.075)	2.3 (0.091)	2.5 (0.098)	—	—	B5
VLP175UAF	23.6 (0.944)	25.6 (1.024)	2.7 (0.108)	2.9 (0.116)	—	0.7 (0.028)	7.0 (0.280)	8.0 (0.320)	7.0 (0.280)	8.0 (0.320)	2.3 (0.092)	2.5 (0.100)	—	—	B5
VLP210F	15.4 (0.616)	17.5 (0.700)	6.9 (0.276)	7.3 (0.292)	0.6 (0.024)	0.8 (0.032)	4.0 (0.160)	6.2 (0.248)	4.0 (0.160)	6.2 (0.248)	3.9 (0.156)	4.1 (0.164)	—	—	B2
VLP220F	21.1 (0.844)	23.3 (0.932)	3.5 (0.140)	3.9 (0.156)	0.6 (0.024)	0.8 (0.032)	5.1 (0.204)	6.8 (0.272)	5.1 (0.204)	6.8 (0.272)	2.9 (0.116)	3.1 (0.124)	—	—	B3
VLP270F	20.9 (0.836)	23.1 (0.924)	4.9 (0.196)	5.3 (0.212)	0.6 (0.024)	0.8 (0.032)	4.1 (0.164)	5.8 (0.232)	4.1 (0.164)	5.8 (0.232)	3.9 (0.156)	4.1 (0.164)	—	—	B3

PolySwitch Resettable Devices

Strap Battery Devices

Table B4 – Dimensions in Millimeters (Inches)

(Cont'd)

Part Number	A		B		C		D		E		F		G		Figure
	Min	Max	Min	Max	Min	Max	Min	Max	Min	Max	Min	Max	Min	Max	
VTP															
VTP110F	23.6 (0.944)	25.6 (1.024)	2.7 (0.108)	2.9 (0.116)	— (0.028)	0.7 (0.028)	7.0 (0.280)	8.0 (0.320)	7.0 (0.280)	8.0 (0.320)	2.3 (0.092)	2.5 (0.100)	— (0.092)	— (0.100)	B5
VTP170F	15.4 (0.616)	17.5 (0.700)	7.0 (0.280)	7.4 (0.296)	0.5 (0.020)	0.8 (0.032)	4.0 (0.160)	6.2 (0.248)	4.0 (0.160)	6.2 (0.248)	3.9 (0.156)	4.1 (0.164)	— (0.156)	— (0.164)	B2
VTP170XSF	20.9 (0.836)	22.9 (0.916)	4.9 (0.196)	5.3 (0.212)	0.5 (0.020)	0.8 (0.032)	6.0 (0.240)	8.6 (0.344)	6.0 (0.240)	8.6 (0.344)	3.9 (0.156)	4.1 (0.164)	— (0.156)	— (0.164)	B4
VTP175F	21.2 (0.848)	23.2 (0.928)	3.5 (0.140)	3.9 (0.156)	— (0.032)	0.8 (0.032)	4.6 (0.184)	6.6 (0.264)	4.6 (0.184)	6.6 (0.264)	2.9 (0.116)	3.1 (0.124)	— (0.116)	— (0.124)	B3
VTP175LF	25.8 (1.032)	28.2 (1.128)	3.5 (0.140)	3.9 (0.156)	— (0.032)	0.8 (0.032)	5.7 (0.228)	7.3 (0.292)	8.7 (0.348)	10.3 (0.412)	2.4 (0.096)	2.6 (0.104)	— (0.096)	— (0.104)	B3
VTP210GF	20.9 (0.836)	23.1 (0.924)	4.9 (0.196)	5.3 (0.212)	— (0.032)	0.8 (0.032)	4.1 (0.164)	5.8 (0.232)	4.1 (0.164)	5.8 (0.232)	3.9 (0.156)	4.1 (0.164)	— (0.156)	— (0.164)	B3
VTP210SF	20.9 (0.836)	23.1 (0.924)	4.9 (0.196)	5.3 (0.212)	0.6 (0.024)	0.8 (0.032)	4.1 (0.164)	5.8 (0.232)	4.1 (0.164)	5.8 (0.232)	3.9 (0.156)	4.1 (0.164)	— (0.156)	— (0.164)	B4
120°C Typical Activation															
MXP															
MXP180	9.4 (0.37)	10.0 (0.39)	2.3 (0.09)	2.6 (0.10)	0.7 (0.02)	1.1 (0.04)	1.9 (0.07)	2.1 (0.08)	— (0.07)	— (0.08)	— (0.07)	— (0.08)	— (0.07)	— (0.08)	B10
MXP190BB	9.2 (0.36)	10.8 (0.43)	2.96 (0.12)	3.26 (0.13)	0.7 (0.03)	1.1 (0.04)	1.6 (0.06)	3.1 (0.12)	1.6 (0.06)	3.1 (0.12)	2.2 (0.09)	2.4 (0.10)	— (0.09)	— (0.10)	B9
MXP250K	11.75 (0.46)	12.35 (0.49)	2.3 (0.09)	2.7 (0.11)	0.7 (0.03)	1.1 (0.04)	2.4 (0.09)	2.6 (0.10)	— (0.09)	— (0.10)	— (0.09)	— (0.10)	— (0.09)	— (0.10)	B10
MXP270	10.3 (0.40)	11.5 (0.45)	2.3 (0.09)	2.7 (0.10)	0.7 (0.02)	1.1 (0.04)	2.1 (0.08)	— (0.08)	2.1 (0.08)	— (0.08)	1.9 (0.07)	2.1 (0.08)	— (0.07)	— (0.08)	B9
MXP310	14.5 (0.57)	16.5 (0.65)	2.96 (0.11)	3.26 (0.13)	0.65 (0.03)	0.95 (0.04)	4.6 (0.18)	— (0.18)	4.6 (0.18)	— (0.18)	2.2 (0.09)	2.4 (0.10)	— (0.09)	— (0.10)	B9
MXP370BD	10.5 (0.41)	11.3 (0.44)	2.96 (0.11)	3.26 (0.12)	0.7 (0.02)	1.1 (0.04)	2.0 (0.07)	— (0.07)	2.0 (0.07)	— (0.07)	2.2 (0.08)	2.4 (0.09)	— (0.08)	— (0.09)	B9
120°C Typical Activation															
MGP															
MGP450	13.0 (0.51)	14.0 (0.55)	2.96 (0.12)	3.26 (0.13)	— (0.04)	0.95 (0.04)	3.0 (0.12)	— (0.12)	3.0 (0.12)	— (0.12)	2.2 (0.09)	2.4 (0.09)	— (0.09)	— (0.09)	B11
MGP500	14.5 (0.57)	15.5 (0.61)	2.96 (0.12)	3.26 (0.13)	— (0.04)	0.95 (0.04)	5.5 (0.22)	7.0 (0.28)	2.0 (0.08)	— (0.08)	2.3 (0.09)	2.5 (0.10)	3.95 (0.16)	4.05 (0.16)	B12
125°C Typical Activation															
SRP															
SRP120F	19.9 (0.796)	22.1 (0.884)	4.9 (0.196)	5.2 (0.208)	0.6 (0.024)	1.0 (0.040)	5.5 (0.220)	7.5 (0.300)	5.5 (0.220)	7.5 (0.300)	3.9 (0.156)	4.1 (0.164)	— (0.156)	— (0.164)	B6
SRP175F	20.9 (0.836)	23.1 (0.924)	4.9 (0.196)	5.2 (0.208)	0.6 (0.024)	1.0 (0.040)	4.1 (0.164)	5.5 (0.220)	4.1 (0.164)	5.5 (0.220)	3.9 (0.156)	4.1 (0.164)	— (0.156)	— (0.164)	B6
SRP200F	21.3 (0.852)	23.4 (0.936)	10.2 (0.408)	11.0 (0.440)	0.5 (0.020)	1.1 (0.044)	5.0 (0.200)	7.6 (0.304)	5.0 (0.200)	7.6 (0.304)	4.8 (0.192)	5.4 (0.216)	— (0.192)	— (0.216)	B6
SRP350F	28.4 (1.136)	31.8 (1.272)	13.0 (0.520)	13.5 (0.540)	0.5 (0.020)	1.1 (0.044)	6.3 (0.252)	8.9 (0.356)	6.3 (0.252)	8.9 (0.356)	6.0 (0.240)	6.6 (0.264)	— (0.240)	— (0.264)	B6
SRP420F	30.6 (1.224)	32.4 (1.296)	12.9 (0.516)	13.6 (0.544)	0.5 (0.020)	1.1 (0.044)	5.0 (0.200)	7.5 (0.300)	5.0 (0.200)	7.5 (0.300)	6.0 (0.240)	6.7 (0.268)	— (0.240)	— (0.268)	B6

PolySwitch Resettable Devices

Strap Battery Devices

Table B4 – Dimensions in Millimeters (Inches)

(Cont'd)

Part Number	A		B		C		D		E		F		G		Figure
	Min	Max	Min	Max	Min	Max	Min	Max	Min	Max	Min	Max	Min	Max	
LR4															
LR4-190F	19.9 (0.796)	22.1 (0.884)	4.9 (0.196)	5.5 (0.220)	0.6 (0.024)	1.0 (0.040)	5.5 (0.220)	7.5 (0.300)	5.5 (0.220)	7.5 (0.300)	3.9 (0.156)	4.1 (0.164)	—	—	B7
LR4-260F	20.9 (0.836)	23.1 (0.924)	4.9 (0.196)	5.5 (0.220)	0.6 (0.024)	1.0 (0.040)	4.1 (0.164)	5.5 (0.220)	4.1 (0.164)	5.5 (0.220)	3.9 (0.156)	4.1 (0.164)	—	—	B7
LR4-380F	24.0 (0.960)	26.0 (1.040)	6.9 (0.276)	7.5 (0.300)	0.6 (0.024)	1.0 (0.040)	4.1 (0.164)	5.5 (0.220)	4.1 (0.164)	5.5 (0.220)	4.9 (0.196)	5.1 (0.204)	—	—	B7
LR4-380XF	32.2 (1.288)	35.8 (1.432)	4.9 (0.196)	5.5 (0.220)	0.6 (0.024)	1.0 (0.040)	5.5 (0.220)	7.5 (0.300)	5.5 (0.220)	7.5 (0.300)	3.9 (0.156)	4.1 (0.164)	—	—	B7
LR4-450F	24.0 (0.960)	26 (1.040)	9.9 (0.396)	10.5 (0.420)	0.6 (0.024)	1.0 (0.040)	5.3 (0.212)	6.7 (0.268)	5.3 (0.212)	6.7 (0.268)	5.9 (0.236)	6.1 (0.244)	—	—	B7
LR4-550F	35.0 (1.400)	37.0 (1.480)	6.9 (0.276)	7.5 (0.300)	0.6 (0.024)	1.0 (0.040)	5.3 (0.212)	6.7 (0.268)	5.3 (0.212)	6.7 (0.268)	4.9 (0.196)	5.1 (0.204)	—	—	B7
LR4-600F	24.0 (0.960)	26.0 (1.040)	13.9 (0.556)	14.5 (0.580)	0.6 (0.024)	1.0 (0.040)	4.1 (0.164)	5.5 (0.220)	4.1 (0.164)	5.5 (0.220)	5.9 (0.236)	6.1 (0.244)	—	—	B7
LR4-600XF	40.5 (1.620)	42.7 (1.708)	6.9 (0.276)	7.5 (0.300)	0.6 (0.024)	1.0 (0.040)	5.2 (0.208)	6.8 (0.272)	5.2 (0.208)	6.8 (0.272)	4.9 (0.196)	5.1 (0.204)	—	—	B7
LR4-730F	27.1 (1.084)	29.1 (1.164)	13.9 (0.556)	14.5 (0.580)	0.6 (0.024)	1.0 (0.040)	4.1 (0.164)	5.5 (0.220)	4.1 (0.164)	5.5 (0.220)	5.9 (0.236)	6.1 (0.244)	—	—	B7
LR4-900F	45.4 (1.816)	47.6 (1.904)	7.9 (0.316)	8.5 (0.340)	0.9 (0.036)	1.3 (0.052)	4.6 (0.184)	6.2 (0.248)	4.6 (0.184)	6.2 (0.248)	5.9 (0.236)	6.1 (0.244)	—	—	B7
LR4-1300SSF	61.5 (2.460)	66.5 (2.660)	9.4 (0.376)	10.0 (0.400)	0.9 (0.036)	1.3 (0.052)	5.0 (0.200)	7.5 (0.300)	5.0 (0.200)	7.5 (0.300)	5.9 (0.236)	6.1 (0.244)	—	—	B8

Figures B13-B19 – Typical Time-to-Trip Curve at 20°C

VLR (data at 25°C)

- A = VLR170F
- B = VLR175F
- C = VLR230F

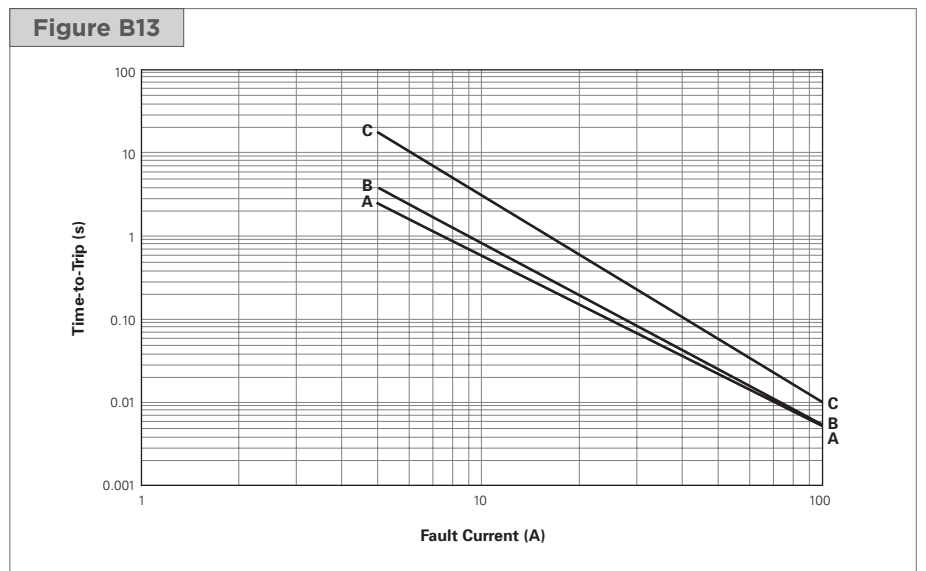

PolySwitch Resettable Devices

Strap Battery Devices

Figures B13-B19 – Typical Time-to-Trip Curve at 20°C

(Cont'd)

VLP (data at 25°C)

- A = VLP120UF
- B = VLP175UAF
- C = VLP210F
- D = VLP220F
- E = VLP270F

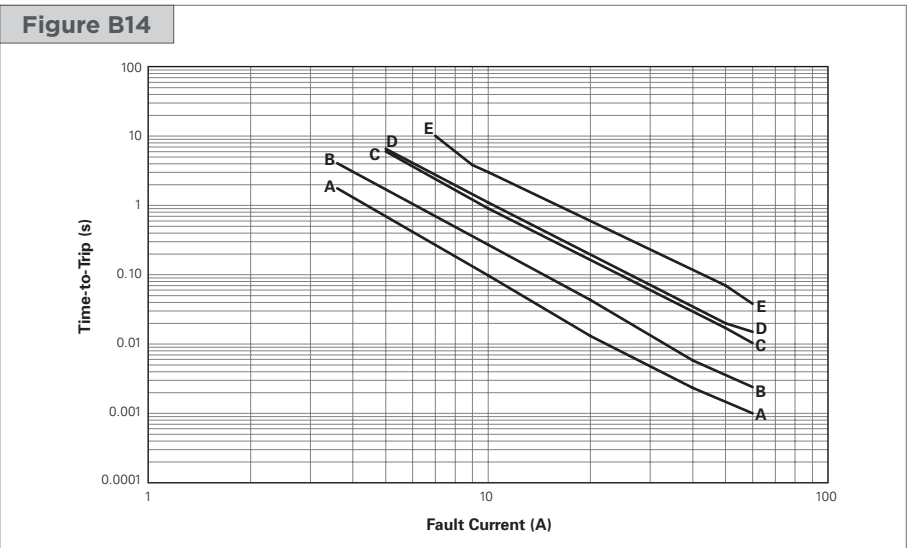

VTP (data at 25°C)

- A = VTP110F
- B = VTP170F
- C = VTP175F
- D = VTP210GF

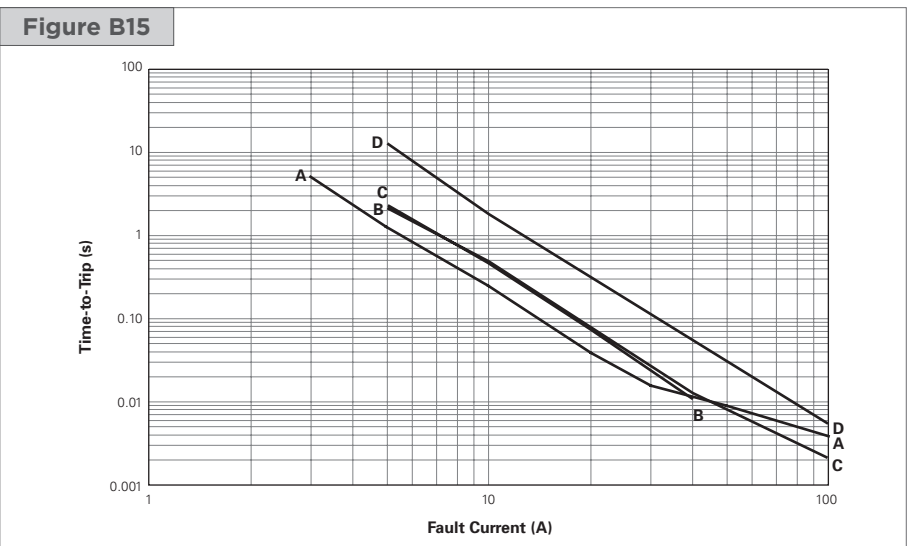

MXP (data at 25°C)

- A = MXP180
- B = MXP190BB
- C = MXP250K
- D = MXP270
- E = MXP310
- F = MXP370BD

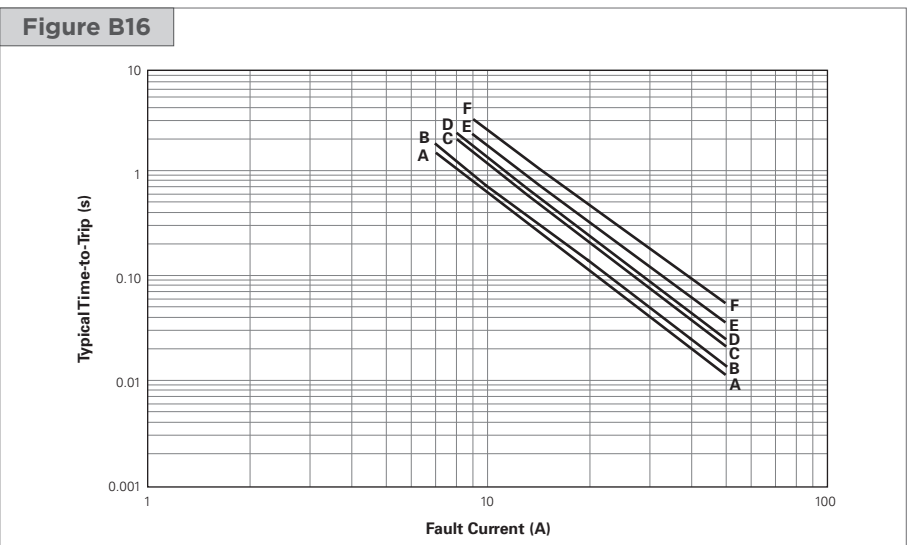

PolySwitch Resettable Devices

Strap Battery Devices

Figures B13-B19 – Typical Time-to-Trip Curve at 20°C

(Cont'd)

MGP

- A = MGP450
- B = MGP500

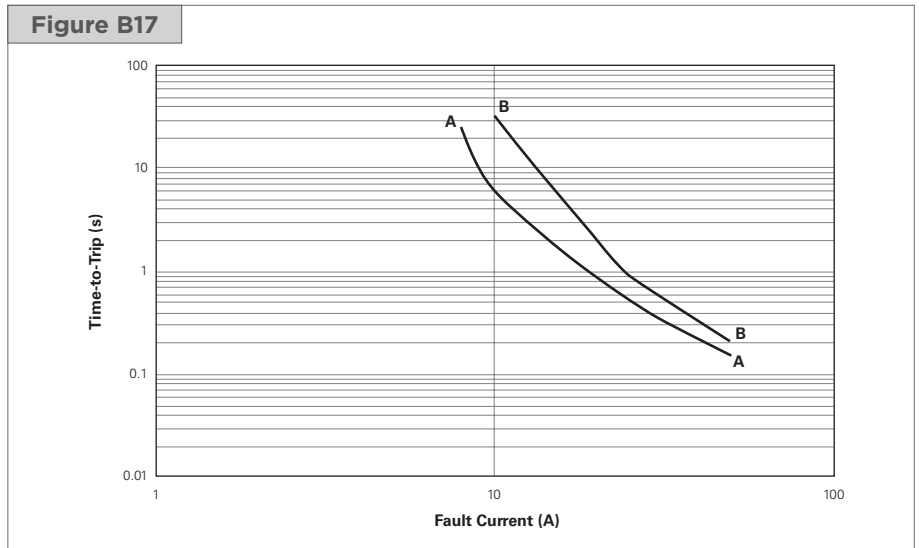

SRP

- A = SRP120F
- B = SRP175F
- C = SRP200F
- D = SRP350F
- E = SRP420F

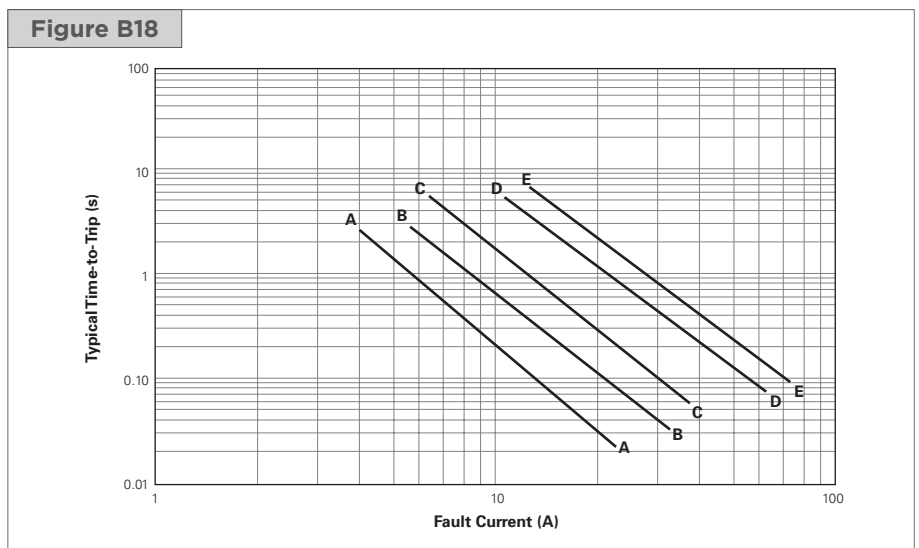

LR4

- A = LR4-190F
- B = LR4-260F
- C = LR4-380F
- D = LR4-450F
- E = LR4-550F
- F = LR4-600F
- G = LR4-730F
- H = LR4-900F
- I = LR4-1300SSF

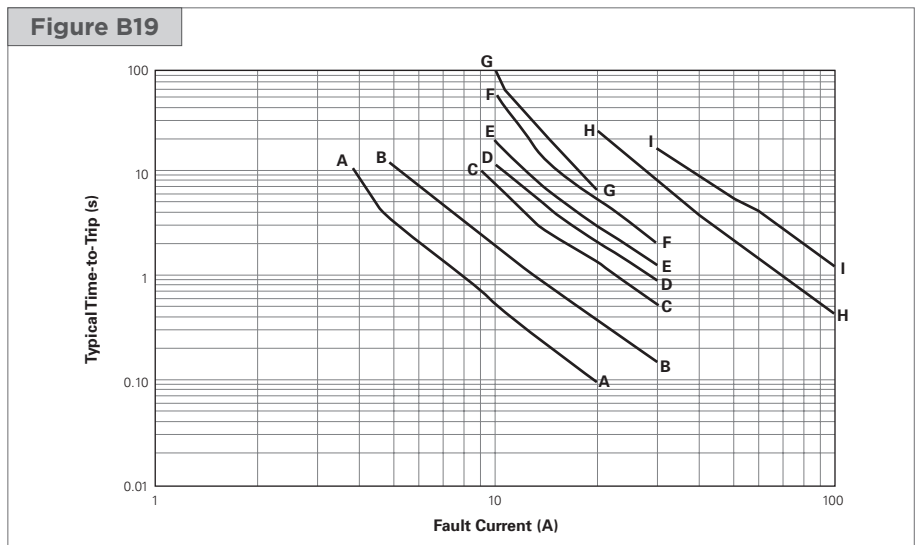

PolySwitch Resettable Devices

Strap Battery Devices

Table B5 – Physical Characteristics and Environmental Specifications

VLR		
Physical Characteristics		
Lead Material	0.125mm Nominal Thickness, Quarter-hard Nickel	
Tape Material	Polyester	
Environmental Specifications		
Test	Conditions	Resistance Change
Passive Aging	-40°C, 1000 hrs	±5% typ
	60°C, 1000 hrs	±20% typ
Humidity Aging	60°C/95% RH, 1000 hrs	±30% typ
Thermal Shock	85°C, -40°C (10 Times)	±5% typ
Vibration	MIL-STD-883D, Method 2026	No Change
VLP and VTP		
Physical Characteristics		
Lead Material	0.125mm Nominal Thickness, Quarter-hard Nickel	
Tape Material	Polyester	
Environmental Specifications		
Test	Conditions	Resistance Change
Passive Aging	-40°C, 1000 hrs	±5% typ
	60°C, 1000 hrs	±10% typ
Humidity Aging	60°C/95% RH, 1000 hrs	±10% typ
Thermal Shock	85°C, -40°C (10 Times)	±5% typ
Vibration	MIL-STD-883D, Method 2026	No Change
MXP and MGP		
Physical Characteristics		
Lead Material	0.1mm Nominal Thickness, Half-hard Nickel	
Coating Material	Epoxy	
Environmental Specifications		
Test	Conditions	Resistance Change
Passive Aging	-40°C, 1000 hrs	±5% typ
	60°C, 1000 hrs	±20% typ
Humidity Aging	60°C/95% RH, 1000 hrs	±30% typ
Thermal Shock	85°C, -40°C (10 Times)	±5% typ
Vibration	MIL-STD-883D, Method 2026	No Change
SRP		
Physical Characteristics		
Lead Material	0.125mm Nominal Thickness, Quarter-hard Nickel	
Tape Material	Polyester	
Environmental Specifications		
Test	Conditions	Resistance Change
Passive Aging	70°C, 1000 hrs	±10% typ
Humidity Aging	85°C/85% RH, 7 Days	±5% typ
Vibration	MIL-STD-883C, Test Condition A	No Change

Note: Storage conditions: 40°C max., 70% RH max.; devices should remain in original sealed bags prior to use. Devices may not meet specified values if these storage conditions are exceeded.

PolySwitch Resettable Devices

Strap Battery Devices

Table B5 – Physical Characteristics and Environmental Specifications

(Cont'd)

LR4		
Physical Characteristics		
Lead Material	0.125mm Nominal Thickness, Quarter-hard Nickel	
Tape Material	Polyester	
Environmental Specifications		
Test	Conditions	Resistance Change
Passive Aging	70°C, 1000 hrs	±10% typ
Humidity Aging	85°C/85% RH, 7 Days	±5% typ
Vibration	MIL-STD-883D, Method 2026	No Change

Note: Storage conditions: 40°C max., 70% RH max.; devices should remain in original sealed bags prior to use. Devices may not meet specified values if these storage conditions are exceeded.

Table B6 – Packaging and Marking Information/Agency Recognition

Part Number	Bag Quantity	Tape and Reel Quantity	Standard Package Quantity	Part Marking	Agency Recognition
85°C Typical Activation					
VLR					
VLR170F	1,000	—	10,000	R17	UL, CSA, TÜV
VLR175F	1,000	—	10,000	R1X	UL, CSA, TÜV
VLR175LF	1,000	—	10,000	R1X	UL, CSA, TÜV
VLR230F	1,000	—	10,000	R23	UL, CSA, TÜV
90°C Typical Activation					
VLP					
VLP120UF	1,000	—	10,000	—	UL, CSA, TÜV
VLP175UAF	1,000	—	10,000	—	UL, CSA, TÜV
VLP210F	1,000	—	10,000	W21	UL, CSA, TÜV
VLP220F	1,000	—	10,000	W22	UL, CSA, TÜV
VLP270F	1,000	—	10,000	W27	UL, CSA, TÜV
VTP					
VTP110F	1,000	—	10,000	—	UL, CSA, TÜV
VTP170F	1,000	—	10,000	V17	UL, CSA, TÜV
VTP170XSF	1,000	—	10,000	V17	UL, CSA, TÜV
VTP175F	1,000	—	10,000	V1X	UL, CSA, TÜV
VTP175LF	1,000	—	10,000	V1X	UL, CSA, TÜV
VTP210GF	1,000	—	10,000	V21	UL, CSA, TÜV
VTP210SF	1,000	—	10,000	V21	UL, CSA, TÜV
120°C Typical Activation					
MXP					
MXP180	2,000	—	48,000	—	UL, CSA, TÜV
MXP190BB	2,000	—	48,000	—	UL, CSA, TÜV
MXP250K	2,000	—	48,000	—	UL, CSA, TÜV
MXP270	2,000	—	48,000	—	UL
MXP310	2,000	—	48,000	—	UL
MXP370BD	2,000	—	48,000	—	UL, CSA, TÜV
120°C Typical Activation					
MGP					
MGP450	2,000	—	48,000	—	—
MGP500	2,000	—	48,000	—	UL, TÜV

PolySwitch Resettable Devices

Strap Battery Devices

Table B6 – Packaging and Marking Information/Agency Recognition

(Cont'd)

Part Number	Bag Quantity	Tape and Reel Quantity	Standard Package Quantity	Part Marking	Agency Recognition
125°C Typical Activation SRP					
SRP120F	1,000	—	10,000	120	UL, CSA, TÜV
SRP175F	2,000	—	10,000	175	UL, CSA, TÜV
SRP200F	1,000	—	10,000	200	UL, CSA, TÜV
SRP350F	500	—	10,000	350	UL, CSA, TÜV
SRP420F	500	—	10,000	420	UL, CSA, TÜV
LR4					
LR4-190F	2,000	—	10,000	E19	UL, CSA, TÜV
LR4-260F	1,000	—	10,000	E26	UL, CSA, TÜV
LR4-380F	1,000	—	10,000	E38	UL, CSA, TÜV
LR4-380XF	1,000	—	10,000	E38	UL, CSA, TÜV
LR4-450F	1,000	—	10,000	E45	UL, CSA, TÜV
LR4-550F	1,000	—	10,000	E55	UL, CSA, TÜV
LR4-600F	1,000	—	10,000	E60	UL, CSA, TÜV
LR4-600XF	1,000	—	10,000	E60	UL, CSA, TÜV
LR4-730F	1,000	—	10,000	E73	UL, CSA, TÜV
LR4-900F	500	—	10,000	E90	UL, CSA, TÜV
LR4-1300SSF	250	—	10,000	EX3	UL, CSA, TÜV

Agency Recognition

UL	File # E74889
CSA	File # 78165C
TÜV	Certificate Number Available on Request

Installation Guidelines for the Strap Family

- PPTC devices operate by thermal expansion of the conductive polymer. If devices are placed under pressure or installed in spaces that would prevent thermal expansion, they may not properly protect against damage caused by fault conditions. Designs must be selected in such a manner that adequate space is maintained over the life of the product.
- Twisting, bending, or placing the PPTC device in tension will decrease the ability of the device to protect against damage caused by electrical faults. No residual force should remain on device after installation. Mechanical damage to the PPTC device may affect device performance and should be avoided.
- Chemical contamination of PPTC devices should be avoided. Certain greases, solvents, hydraulic fluids, fuels, industrial cleaning agents, volatile components of adhesives, silicones, and electrolytes can have an adverse effect on device performance.
- PPTC strap devices are intended to be resistance welded to battery cells or to pack interconnect straps, yet some precautions must be taken when doing so. In order for the PPTC device to exhibit its specified performance, weld placement should be a minimum of 2mm from the edge of the PPTC device, weld splatter must not touch the PPTC device, and welding conditions must not heat the PPTC device above its maximum operating temperature.
- PPTC strap devices are not intended for applications where reflow onto flex circuits or rigid circuit boards is required.
- The polyester tape on PPTC strap devices is intended for marking and identification purposes only, not for electrical insulation.
- The coating on MXP and MGP devices is intended to prevent oxidization/aging of the devices. Damaging the coating or causing the coating to delaminate can have negative effects on device performance and should be avoided.
- MXP and MGP devices have a small PPTC chip size and therefore have weaker peel strength between the polymer and Ni-foil of the chip. Excessive mechanical force to the device may cause delamination of Ni-foil from the polymer.

PolySwitch Resettable Devices

Strap Battery Devices

Part Numbering System

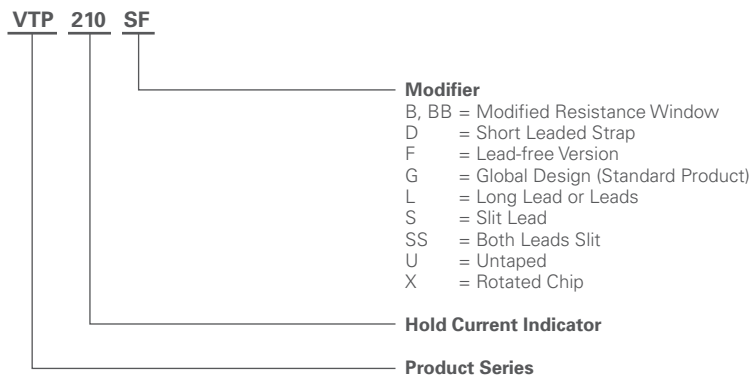

Warning :

- Users should independently evaluate the suitability of and test each product selected for their own application.
- Operation beyond the maximum ratings or improper use may result in device damage and possible electrical arcing and flame.
- These devices are intended for protection against damage caused by occasional overcurrent or overtemperature fault conditions and should not be used when repeated fault conditions or prolonged trip events are anticipated.
- Contamination of the PPTC material with certain silicone-based oils or some aggressive solvents can adversely impact the performance of the devices.
- Device performance can be impacted negatively if devices are handled in a manner inconsistent with recommended electronic, thermal, and mechanical procedures for electronic components.
- PPTC devices are not recommended for installation in applications where the device is constrained such that its PTC properties are inhibited, for example in rigid potting materials or in rigid housings, which lack adequate clearance to accommodate device expansion.
- Operation in circuits with a large inductance can generate a circuit voltage (Ldi/dt) above the rated voltage of the device.

Notice:

Information furnished is believed to be accurate and reliable. However, users should independently evaluate the suitability of and test each product selected for their own applications. Littelfuse products are not designed for, and shall not be used for, any purpose (including, without limitation, military, aerospace, medical, life-saving, life-sustaining or nuclear facility applications, devices intended for surgical implant into the body, or any other application in which the failure or lack of desired operation of the product may result in personal injury, death, or property damage) other than those expressly set forth in applicable Littelfuse product documentation. Warranties granted by Littelfuse shall be deemed void for products used for any purpose not expressly set forth in applicable Littelfuse documentation. Littelfuse shall not be liable for any claims or damages arising out of products used in applications not expressly intended by Littelfuse as set forth in applicable Littelfuse documentation. The sale and use of Littelfuse products is subject to Littelfuse Terms and Conditions of Sale, unless otherwise agreed by Littelfuse.