



Chipsmall Limited consists of a professional team with an average of over 10 year of expertise in the distribution of electronic components. Based in Hongkong, we have already established firm and mutual-benefit business relationships with customers from,Europe,America and south Asia,supplying obsolete and hard-to-find components to meet their specific needs.

With the principle of “Quality Parts,Customers Priority,Honest Operation,and Considerate Service”,our business mainly focus on the distribution of electronic components. Line cards we deal with include Microchip,ALPS,ROHM,Xilinx,Pulse,ON,Everlight and Freescale. Main products comprise IC,Modules,Potentiometer,IC Socket,Relay,Connector.Our parts cover such applications as commercial,industrial, and automotives areas.

We are looking forward to setting up business relationship with you and hope to provide you with the best service and solution. Let us make a better world for our industry!



Contact us

Tel: +86-755-8981 8866 Fax: +86-755-8427 6832

Email & Skype: info@chipsmall.com Web: www.chipsmall.com

Address: A1208, Overseas Decoration Building, #122 Zhenhua RD., Futian, Shenzhen, China





High Brightness LED Power Module



DESCRIPTION

VLPC0101C6, VLPN0101C6, and VLPW0101C6 are high brightness LED modules. The 4.55 W multichip power LED is soldered on a Cu plate. The Cu plate with a thickness of 1.2 mm guarantees best heat removal and distribution. VLPC0101C6 is the cool white version in a color temperature range of 5000 K to 6650 K. VLPN0101C6 is natural white with a color temperature of 3680 K to 4350 K and VLPW0101C6 is warm white in a color temperature range of 2670 K to 3120 K. Additional to the modules a suitable LED driver is available.

PRODUCT GROUP AND PACKAGE DATA

- Product group: LED
- Package: LED module
- Product series: power
- Angle of half intensity: $\pm 65^\circ$
- CRI: 80

FEATURES

- Cu based PCB, 1.2 mm thickness
- Shiny white surface
- 4.55 W multichip LED, minimum 390 lm for cool white, 330 lm for natural white, and 290 lm for warm white at 700 mA each
- ESD withstand voltage: Up to 1 kV according to JESD22-A114-B
- CRI: 80
- Color temperature binning
- Material categorization: For definitions of compliance please see www.vishay.com/doc?99912



RoHS
COMPLIANT
HALOGEN
FREE
GREEN
(5-2008)

APPLICATIONS

- Internal lighting in buildings
- Tunnel lights
- Reading lamp, table lamp
- General lighting application

PARTS TABLE						
PART	COLOR	LUMINOUS FLUX (lm) (at $I_F = 700$ mA typ.)			COLOR TEMPERATURE K	TECHNOLOGY
		MIN.	TYP.	MAX.		
VLPC0101C6	Cool white	390	430	-	5000 to 6650	InGaN
VLPN0101C6	Natural white	330	410	-	3710 to 4260	InGaN
VLPW0101C6	Warm white	290	320	-	2670 to 3120	InGaN

ABSOLUTE MAXIMUM RATINGS ($T_{amb} = 25^\circ\text{C}$, unless otherwise specified) VLPC0101C6, VLPN0101C6, VLPW0101C6					
PARAMETER	TEST CONDITION	SYMBOL	VALUE	UNIT	
Forward current	$T_{amb} < 80^\circ\text{C}$	I_F	1400	mA	
Power dissipation	$T_{amb} < 80^\circ\text{C}$	P_{tot}	10	W	
Junction temperature		T_j	115	$^\circ\text{C}$	
Operating temperature range		T_{amb}	-40 to +80	$^\circ\text{C}$	
Storage temperature range		T_{stg}	-40 to +100	$^\circ\text{C}$	
Thermal resistance		R_{thJS}	3	K/W	
Pad soldering temperature	10 s	T_{SD}	260	$^\circ\text{C}$	

**OPTICAL AND ELECTRICAL CHARACTERISTICS** ($T_{amb} = 25\text{ }^{\circ}\text{C}$, unless otherwise specified)
VLPC0101C6, COOL WHITE

PARAMETER	TEST CONDITION	SYMBOL	MIN.	TYP.	MAX.	UNIT
Luminous flux	$I_F = 700\text{ mA}$	Φ_V	390	430	-	lm
	$I_F = 1000\text{ mA}$	Φ_V	-	570	-	lm
	$I_F = 1400\text{ mA}$	Φ_V	-	700	-	lm
Color temperature	$I_F = 700\text{ mA}$	CCT	5000	5700	6650	K
Chromaticity coordinates	$I_F = 700\text{ mA}$	x	-	0.3287	-	
	$I_F = 700\text{ mA}$	y	-	0.3417	-	
Full angle of half intensity	$I_F = 700\text{ mA}$	$2\phi_{1/2}$	-	130	-	$^{\circ}$
Forward voltage	$I_F = 700\text{ mA}$	V_F	6.0	6.5	6.8	V
Temperature coefficient of V_F	$I_F = 700\text{ mA}$	TCV_F	-	2.0	-	mV/K
Temperature coefficient of Φ_V	$I_F = 700\text{ mA}$	$TC\Phi_V$	-	0.21	-	%/K

Notes

- Forward voltages are tested at a current pulse duration of 1 ms and a tolerance of $\pm 0.1\text{ V}$. Luminous flux is measured at a current pulse duration of 25 ms and an accuracy of $\pm 11\%$.
- CRI: 80

OPTICAL AND ELECTRICAL CHARACTERISTICS ($T_{amb} = 25\text{ }^{\circ}\text{C}$, unless otherwise specified)
VLPN0101C6, NATURAL WHITE

PARAMETER	TEST CONDITION	SYMBOL	MIN.	TYP.	MAX.	UNIT
Luminous flux	$I_F = 700\text{ mA}$	Φ_V	330	410	-	lm
	$I_F = 1000\text{ mA}$	Φ_V	-	560	-	lm
	$I_F = 1400\text{ mA}$	Φ_V	-	680	-	lm
Color temperature	$I_F = 700\text{ mA}$	CCT	3710	4000	4260	K
Chromaticity coordinates	$I_F = 700\text{ mA}$	x	-	0.3818	-	
	$I_F = 700\text{ mA}$	y	-	0.3797	-	
Full angle of half intensity	$I_F = 700\text{ mA}$	$2\phi_{1/2}$	-	130	-	$^{\circ}$
Forward voltage	$I_F = 700\text{ mA}$	V_F	6.0	6.5	6.8	V
Temperature coefficient of V_F	$I_F = 700\text{ mA}$	TCV_F	-	2.0	-	mV/K
Temperature coefficient of Φ_V	$I_F = 700\text{ mA}$	$TC\Phi_V$	-	0.21	-	%/K

Notes

- Forward voltages are tested at a current pulse duration of 1 ms and a tolerance of $\pm 0.1\text{ V}$. Luminous flux is measured at a current pulse duration of 25 ms and an accuracy of $\pm 11\%$.
- CRI: 80

OPTICAL AND ELECTRICAL CHARACTERISTICS ($T_{amb} = 25\text{ }^{\circ}\text{C}$, unless otherwise specified)
VLPW0101C6, WARM WHITE

PARAMETER	TEST CONDITION	SYMBOL	MIN.	TYP.	MAX.	UNIT
Luminous flux	$I_F = 700\text{ mA}$	Φ_V	290	320	-	lm
	$I_F = 1000\text{ mA}$	Φ_V	-	400	-	lm
	$I_F = 1400\text{ mA}$	Φ_V	-	480	-	lm
Color temperature	$I_F = 700\text{ mA}$	CCT	2670	2870	3120	K
Chromaticity coordinates	$I_F = 700\text{ mA}$	x	-	0.4450	-	
	$I_F = 700\text{ mA}$	y	-	0.4060	-	
Full angle of half intensity	$I_F = 700\text{ mA}$	$2\phi_{1/2}$	-	130	-	$^{\circ}$
Forward voltage	$I_F = 700\text{ mA}$	V_F	6.0	6.5	6.8	V
Temperature coefficient of V_F	$I_F = 700\text{ mA}$	TCV_F	-	2.0	-	mV/K
Temperature coefficient of Φ_V	$I_F = 700\text{ mA}$	$TC\Phi_V$	-	0.21	-	%/K

Notes

- Forward voltages are tested at a current pulse duration of 1 ms and a tolerance of $\pm 0.1\text{ V}$. Luminous flux is measured at a current pulse duration of 25 ms and an accuracy of $\pm 11\%$.
- CRI: 80

COLOR BINNING (I _F at 700 mA)		
PART	BIN CODE	CCT (K)
VLPC0101C6	1B	6020 to 6530
	2A	5665 to 6020
	2B	5310 to 5665
	3A	5028 to 5310
VLPN0101C6	5A	3985 to 4260
	5B	3710 to 3985
VLPW0101C6	7B	2870 to 3045
	8A	2725 to 2870

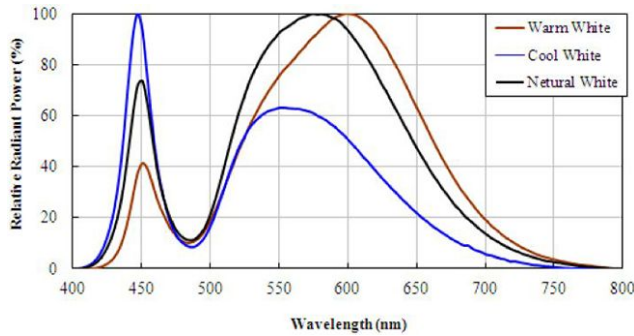

Fig. 1 - Relative Spectrale Emission

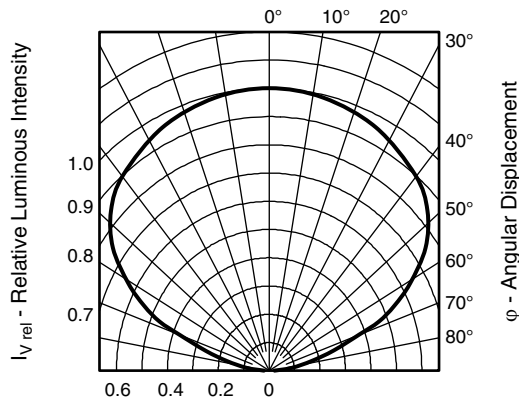

Fig. 2 - Relative Intensity vs. Angular Displacement

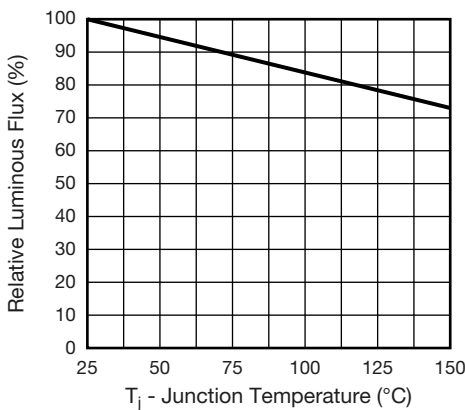
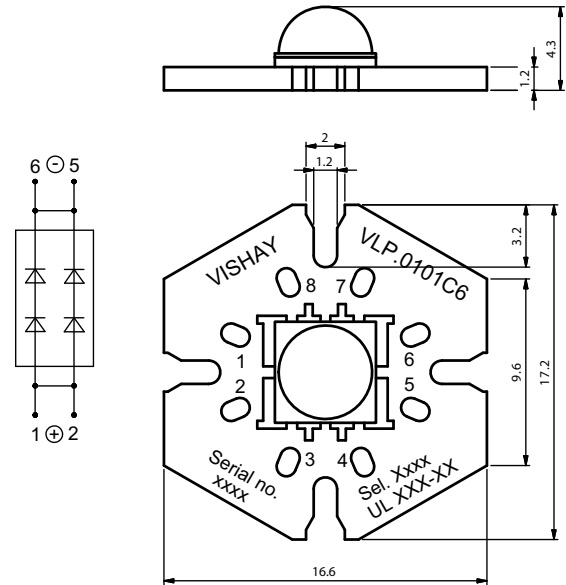

Fig. 3 - Relative Luminous Flux vs. Junction Temperature (I_F = 3200 mA)

PACKAGE DIMENSIONS in millimeters



Not indicated tolerances ± 0.2

Drawing refers to following types: VLP.0101C6

Drawing-No.: 9.920-6807.02-4
Issue: 2; 20.11.2012

Technical drawings according to DIN specification.

BAR CODE PRODUCT LABEL

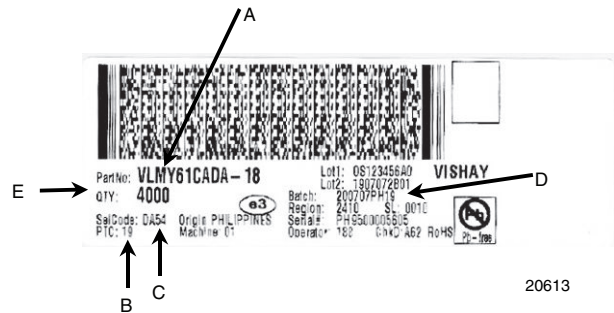

- A. Type of component
- B. Manufacturing plant
- C. SEL - selection code (bin):
X = color group
- D. Batch:
200707 = year 2007, week 07
PH19 = plant code
- E. Total quantity

Note

- Delivery on reel Ø 330 mm, 1500 pieces per reel

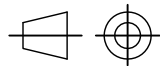
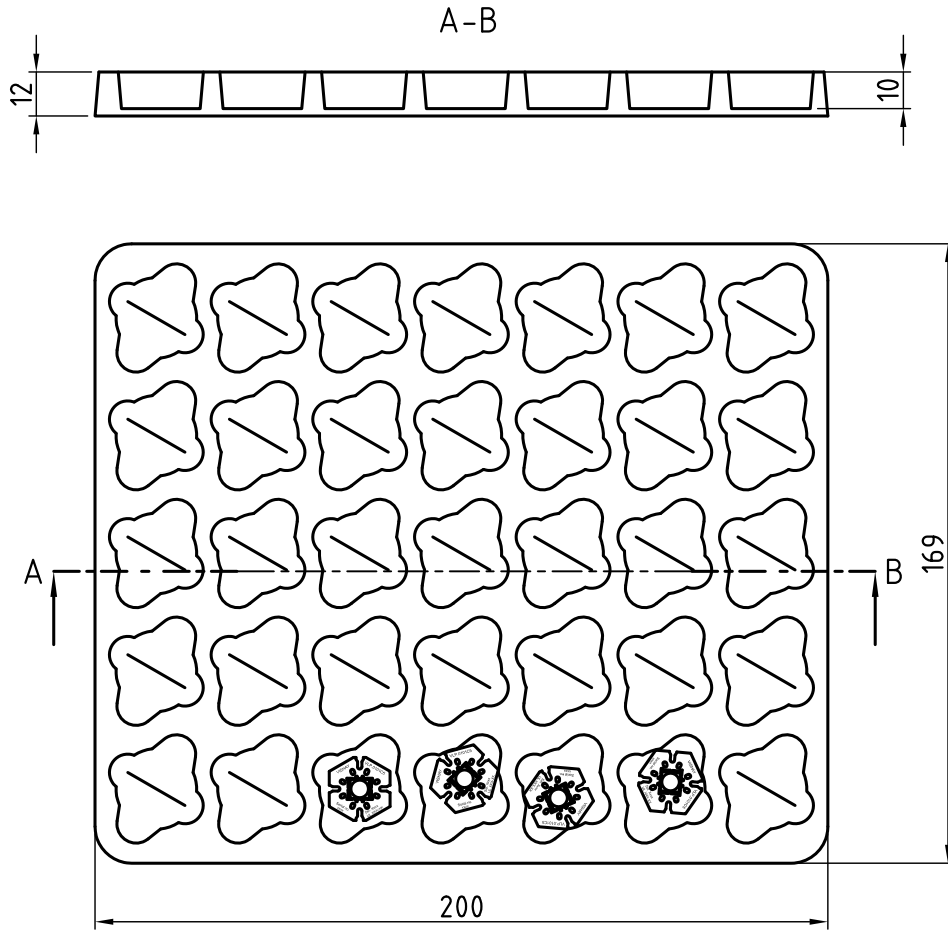

technical drawings
according to DIN
specifications

Drawing-No.: 9.700-5389.01-4

Issue: prel; 18.07.12

Fig. 4 - Tray with 7 x 5 Pieces

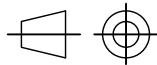
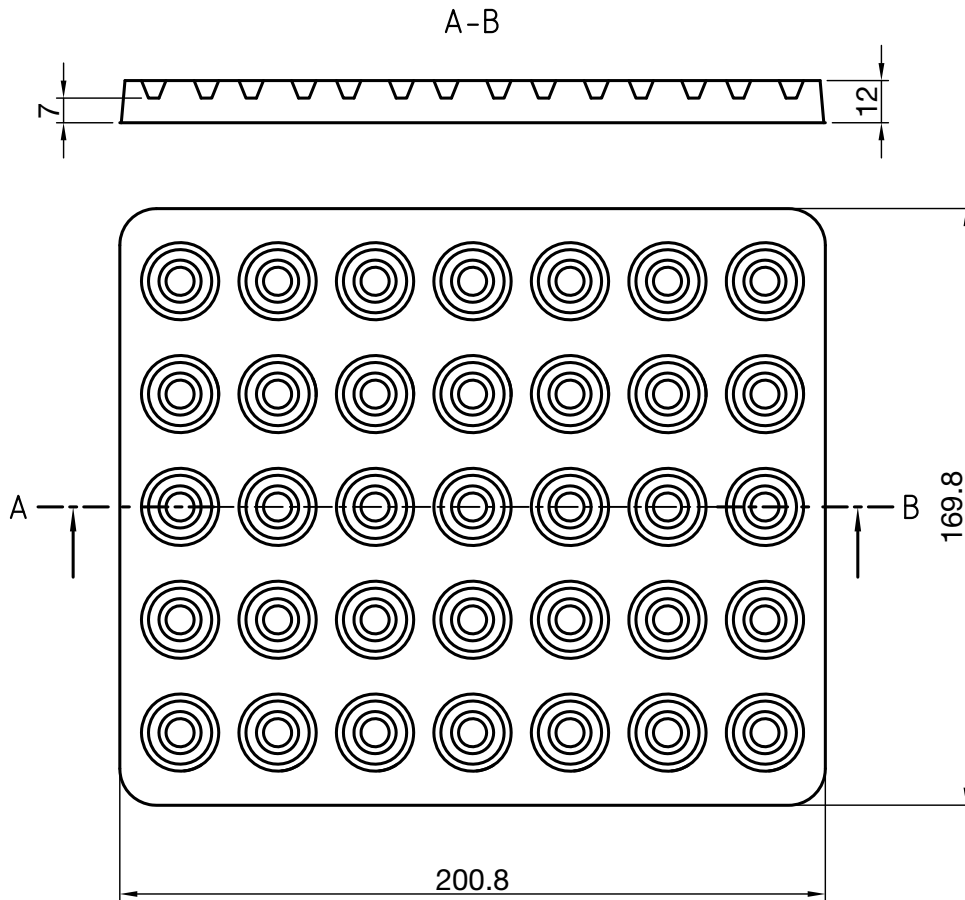

technical drawings according to DIN specifications

Drawing-No.: 9.700-5390.01-4

Issue: prel; 18.07.12

Fig. 5 - Tray Cover

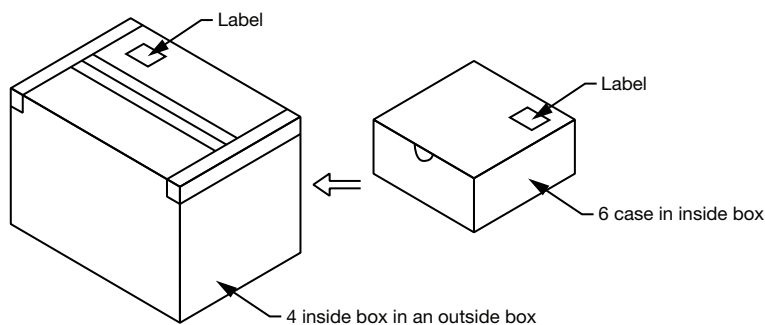

Fig. 6 - Box



Disclaimer

ALL PRODUCT, PRODUCT SPECIFICATIONS AND DATA ARE SUBJECT TO CHANGE WITHOUT NOTICE TO IMPROVE RELIABILITY, FUNCTION OR DESIGN OR OTHERWISE.

Vishay Intertechnology, Inc., its affiliates, agents, and employees, and all persons acting on its or their behalf (collectively, "Vishay"), disclaim any and all liability for any errors, inaccuracies or incompleteness contained in any datasheet or in any other disclosure relating to any product.

Vishay makes no warranty, representation or guarantee regarding the suitability of the products for any particular purpose or the continuing production of any product. To the maximum extent permitted by applicable law, Vishay disclaims (i) any and all liability arising out of the application or use of any product, (ii) any and all liability, including without limitation special, consequential or incidental damages, and (iii) any and all implied warranties, including warranties of fitness for particular purpose, non-infringement and merchantability.

Statements regarding the suitability of products for certain types of applications are based on Vishay's knowledge of typical requirements that are often placed on Vishay products in generic applications. Such statements are not binding statements about the suitability of products for a particular application. It is the customer's responsibility to validate that a particular product with the properties described in the product specification is suitable for use in a particular application. Parameters provided in datasheets and/or specifications may vary in different applications and performance may vary over time. All operating parameters, including typical parameters, must be validated for each customer application by the customer's technical experts. Product specifications do not expand or otherwise modify Vishay's terms and conditions of purchase, including but not limited to the warranty expressed therein.

Except as expressly indicated in writing, Vishay products are not designed for use in medical, life-saving, or life-sustaining applications or for any other application in which the failure of the Vishay product could result in personal injury or death. Customers using or selling Vishay products not expressly indicated for use in such applications do so at their own risk. Please contact authorized Vishay personnel to obtain written terms and conditions regarding products designed for such applications.

No license, express or implied, by estoppel or otherwise, to any intellectual property rights is granted by this document or by any conduct of Vishay. Product names and markings noted herein may be trademarks of their respective owners.

Material Category Policy

Vishay Intertechnology, Inc. hereby certifies that all its products that are identified as RoHS-Compliant fulfill the definitions and restrictions defined under Directive 2011/65/EU of The European Parliament and of the Council of June 8, 2011 on the restriction of the use of certain hazardous substances in electrical and electronic equipment (EEE) - recast, unless otherwise specified as non-compliant.

Please note that some Vishay documentation may still make reference to RoHS Directive 2002/95/EC. We confirm that all the products identified as being compliant to Directive 2002/95/EC conform to Directive 2011/65/EU.

Vishay Intertechnology, Inc. hereby certifies that all its products that are identified as Halogen-Free follow Halogen-Free requirements as per JEDEC JS709A standards. Please note that some Vishay documentation may still make reference to the IEC 61249-2-21 definition. We confirm that all the products identified as being compliant to IEC 61249-2-21 conform to JEDEC JS709A standards.