



Chipsmall Limited consists of a professional team with an average of over 10 year of expertise in the distribution of electronic components. Based in Hongkong, we have already established firm and mutual-benefit business relationships with customers from,Europe,America and south Asia,supplying obsolete and hard-to-find components to meet their specific needs.

With the principle of “Quality Parts,Customers Priority,Honest Operation,and Considerate Service”,our business mainly focus on the distribution of electronic components. Line cards we deal with include Microchip,ALPS,ROHM,Xilinx,Pulse,ON,Everlight and Freescale. Main products comprise IC,Modules,Potentiometer,IC Socket,Relay,Connector.Our parts cover such applications as commercial,industrial, and automotives areas.

We are looking forward to setting up business relationship with you and hope to provide you with the best service and solution. Let us make a better world for our industry!



Contact us

Tel: +86-755-8981 8866 Fax: +86-755-8427 6832

Email & Skype: info@chipsmall.com Web: www.chipsmall.com

Address: A1208, Overseas Decoration Building, #122 Zhenhua RD., Futian, Shenzhen, China



Quad smart power solid-state relay for complete H-bridge configurations

Datasheet - production data

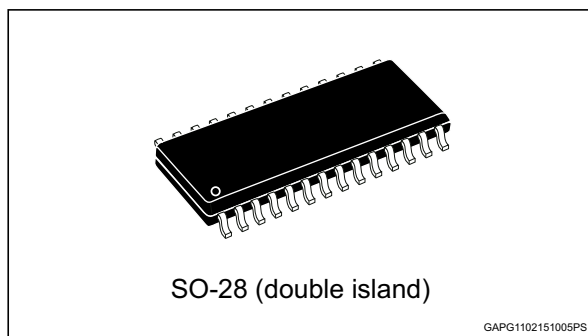

Features

Type	$R_{DS(on)}$	I_{OUT}	V_{CC}
VN5772AK-E	100 m Ω ⁽¹⁾	18 A ⁽²⁾	36 V

- Total resistance of one side in bridge configuration.
- Typical current limitation value.

- General features
 - Inrush current management by active power limitation on the high-side switches
 - Very low standby current
 - Very low electromagnetic susceptibility
 - Compliant with European directive 2002/95/EC
- Protections
 - High-side drivers under voltage shutdown
 - Overvoltage clamp
 - Output current limitation
 - High and low-side overtemperature shutdown
 - Short-circuit protection
 - ESD protection
- Diagnostic functions
 - Proportional load current sense
 - Thermal shutdown indication on both the high and low-side switches

Applications

- DC motor driving in full or half-bridge configuration
- All types of resistive, inductive and capacitive loads

Description

The VN5772AK-E is a device formed by three monolithic chips housed in a standard SO-28 package: a double high-side and two low-side switches. The double high-side is made using STMicroelectronics® VIPower® M0-5 technology, while the low-side switches are fully protected VIPower M0-5 OMNIFET III. This device is suitable to drive a DC motor in a bridge configuration as well as to be used as a quad switch for any low-voltage application. The dual high-side switches integrate built-in non latching thermal shutdown with thermal hysteresis. An output current limiter protects the device in overload conditions. In the case of long overload duration, the device limits the dissipated power to a safe level up to thermal shutdown intervention. An analog current sense pin delivers a current proportional to the load current (according to a known ratio) and indicates overtemperature shutdown of the relevant high-side switch through a voltage flag. The low-side switches have built-in non latching thermal shutdown with thermal hysteresis, linear current limitation and overvoltage clamping. In case of long overload duration, the low-side switches limit the dissipated power to a safe level up to the thermal shutdown intervention. Fault feedback for overtemperature shutdown of the low-side switch is indicated by the relevant status pin.

Table 1. Device summary

Package	Order codes	
	Tube	Tape and reel
SO-28	VN5772AK-E	VN5772AKTR-E

Contents

1	Block diagram and pin description	5
2	Electrical specification	7
2.1	Absolute maximum ratings	7
2.2	Thermal data	8
2.3	Electrical characteristics	9
2.3.1	Electrical characteristics for dual high-side switches	9
2.4	Electrical characteristics curves for dual high-side switches	15
2.5	Electrical characteristics for low-side switch	17
2.6	Electrical characteristics curves for low-side switch	19
3	Application information	21
3.1	Maximum demagnetization energy ($V_{CC} = 13.5\text{ V}$)	24
4	Package and PC board thermal data	25
4.1	SO-28 thermal data	25
5	Package information	30
5.1	SO-28 package mechanical data	30
5.2	Packing information	32
6	Revision history	33

List of tables

Table 1.	Device summary	1
Table 2.	Pin description	6
Table 3.	Dual high-side switch	7
Table 4.	Low side switch.	8
Table 5.	Thermal data.	8
Table 6.	Power section	9
Table 7.	Switching (VCC = 13 V)	9
Table 8.	Logic inputs.	10
Table 9.	Protection and diagnostics	10
Table 10.	Current sense (8 V < VCC < 16 V)	11
Table 11.	Truth table high-side driver.	13
Table 12.	Electrical transient requirements (part 1/3).	14
Table 13.	Electrical transient requirements (part 2/3).	14
Table 14.	Electrical transient requirements (part 3/3).	14
Table 15.	PowerMOS section - off	17
Table 16.	PowerMOS section - on	17
Table 17.	Switching (T _j = 25° C, unless otherwise specified)	17
Table 18.	Source drain diode	17
Table 19.	Input section	17
Table 20.	STATUS pin	18
Table 21.	Protection and diagnostics (-40 °C < T _j < 150 °C, unless otherwise specified)	18
Table 22.	Truth table low-side driver.	18
Table 23.	Thermal calculations in clockwise and anti-clockwise operation in steady-state mode	26
Table 24.	Thermal resistances definitions	26
Table 25.	Single pulse thermal impedance definitions	26
Table 26.	Thermal calculations in transient mode	27
Table 27.	Thermal parameters	29
Table 28.	SO-28 mechanical data	30
Table 29.	Document revision history.	33

List of figures

Figure 1.	Block diagram	5
Figure 2.	Configuration diagram (top view)	6
Figure 3.	Current sense delay characteristics	12
Figure 4.	Switching time waveforms	12
Figure 5.	Output voltage drop limitation	12
Figure 6.	Off-state output current	15
Figure 7.	High-level input current	15
Figure 8.	Input voltage clamp	15
Figure 9.	Low level input voltage	15
Figure 10.	High-level input voltage	15
Figure 11.	Input voltage hysteresis	15
Figure 12.	On-state resistance vs T_{case}	16
Figure 13.	On-state resistance vs V_{CC}	16
Figure 14.	Undervoltage shutdown	16
Figure 15.	Turn-on voltage slope	16
Figure 16.	I_{LIMH} vs T_{case}	16
Figure 17.	Turn-off voltage slope	16
Figure 18.	Source diode forward characteristics	19
Figure 19.	Static drain source on-resistance vs drain current (3 pin)	19
Figure 20.	Static drain source on-resistance vs input voltage (3 pin)	19
Figure 21.	Static drain source on-resistance vs drain current	19
Figure 22.	Transfer characteristics	19
Figure 23.	Output characteristics	19
Figure 24.	Normalized on-resistance vs temperature	20
Figure 25.	Normalized input threshold vs temperature	20
Figure 26.	Typical application schematic	21
Figure 27.	Recommended motor operation	22
Figure 28.	Waveforms (high-side switches)	23
Figure 29.	Maximum turn-off current vs load inductance	24
Figure 30.	SO-28 PC board	25
Figure 31.	Chipset configuration	25
Figure 32.	Auto and mutual $R_{thj-amb}$ vs PCB copper area in open box free air condition	26
Figure 33.	SO-28 HSD thermal impedance junction-ambient single pulse	27
Figure 34.	SO-28 LSD thermal impedance junction-ambient single pulse	28
Figure 35.	Thermal fitting model of an H-bridge in SO-28	29
Figure 36.	SO-28 package outline	30
Figure 37.	SO-28 tube shipment (no suffix)	32
Figure 38.	SO-28 tape and reel shipment (suffix "TR")	32

1 Block diagram and pin description

Figure 1. Block diagram

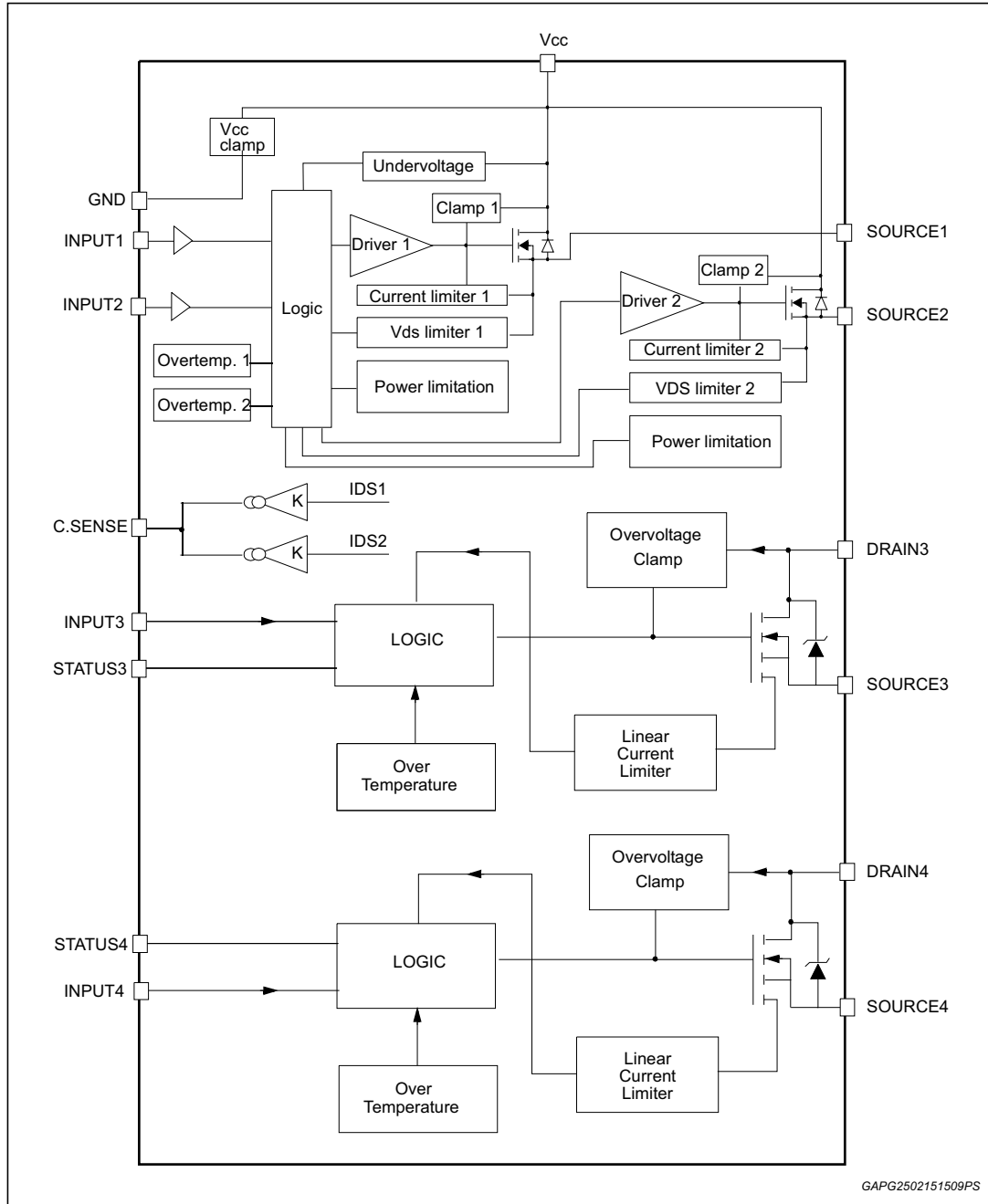
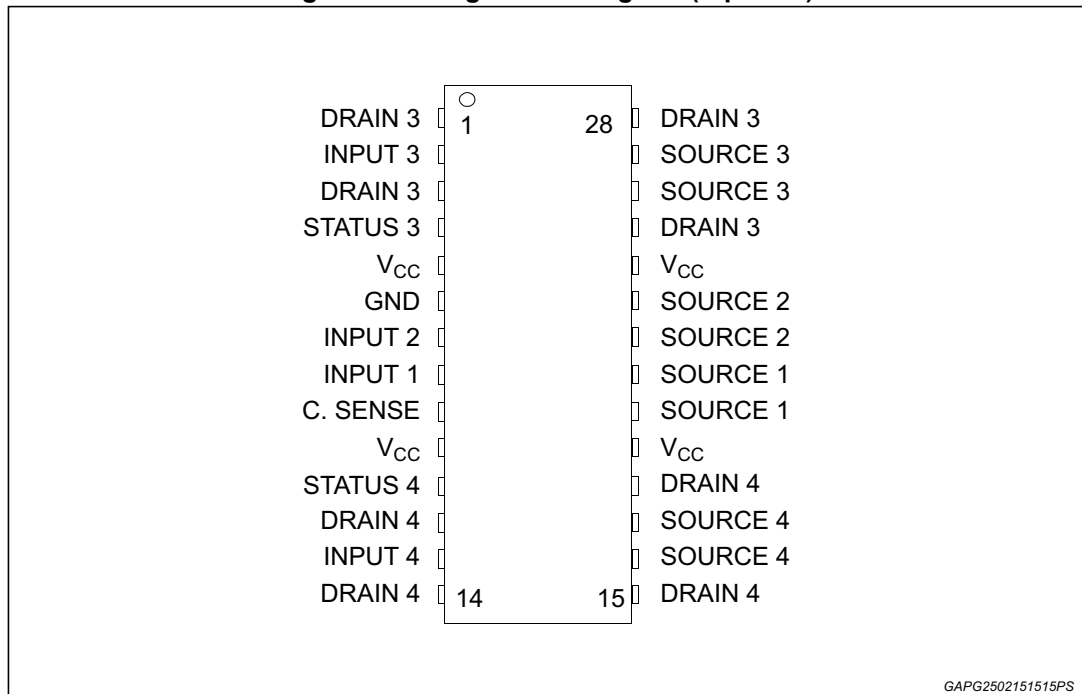

Table 2. Pin description

N° pin	Name	Function
1, 3, 25, 28	DRAIN 3	Drain of switch 3 (low-side switches)
2	INPUT 3	Input of switch 3 (low-side switch)
4	STATUS 3	Status of switch 3 (low-side switch)
11	STATUS 4	Status of switch 4 (low-side switch)
5, 10, 19, 24	V _{CC}	Drain of switches 1 and 2 (high-side switches) and power supply voltage
6	GND	Ground of switches 1 and 2 (high-side switches)
8	INPUT 1	Input of switch 1 (high-side switch)
7	INPUT 2	Input of switch 2 (high-side switch)
9	C.SENSE	Analog current sense pin, delivers a current proportional to the load current
12, 14, 15, 18	DRAIN 4	Drain of switch 4 (low-side switches)
13	INPUT 4	Input of switch 4 (low-side switch)
16, 17	SOURCE 4	Source of switch 4 (low-side switches)
22, 23	SOURCE 2	Source of switch 2 (high-side switches)
20, 21	SOURCE 1	Source of switch 1 (high-side switches)
26, 27	SOURCE 3	Source of switch 3 (low-side switches)

Figure 2. Configuration diagram (top view)



2 Electrical specification

2.1 Absolute maximum ratings

Stressing the device above the rating listed in the “absolute maximum ratings” table may cause permanent damage to the device. These are stress ratings only and operation of the device at these or any other conditions above those indicated in the operating sections of this specification is not implied. Exposure to the conditions in the tables below for extended periods may affect device reliability. Refer also to the STMicroelectronics SURE program and other relevant quality document.

Table 3. Dual high-side switch

Symbol	Parameter	Value	Unit
V_{CC}	DC supply voltage	41	V
$-V_{CC}$	Reverse DC supply voltage	0.3	V
$-I_{GND}$	DC reverse ground pin current	200	mA
I_{OUT}	DC output current	Internally limited	A
$-I_{OUT}$	Reverse DC output current	-12	A
I_{IN}	DC input current	-1 to 10	mA
$-I_{CSENSE}$	DC reverse C.SENSE pin current	200	mA
V_{CSENSE}	Current sense maximum voltage	$V_{CC} - 41$ $+V_{CC}$	V V
E_{MAX}	Maximum switching energy (single pulse) ($L = 3\text{ mH}$; $R_L = 0\ \Omega$; $V_{bat} = 13.5\text{ V}$; $T_{jstart} = 150\text{ }^\circ\text{C}$; $I_{OUT} = I_{limL}(Typ.)$)	104	mJ
V_{ESD}	Electrostatic discharge (human body model: $R = 1.5\text{ K}\Omega$; $C = 100\text{ pF}$) – Input – Current sense – $SOURCE_n/DRAIN_n$ – V_{CC}	4000 2000 5000 5000	V V V V
V_{ESD}	Charge device model (CDM-AEC-Q100-011)	750	V
T_j	Junction operating temperature	-40 to 150	$^\circ\text{C}$
T_{stg}	Storage temperature	-55 to 150	$^\circ\text{C}$

Table 4. Low side switch

Symbol	Parameter	Value	Unit
V_{DSn}	Drain-source voltage ($V_{INn} = 0$ V)	Internally clamped	V
I_{INn}	Input current	-1 to 10	mA
I_{Dn}	Drain current	Internally limited	A
$-I_{Dn}$	Reverse DC output current	-4	A
I_{STAT}	DC status current	-1 to 10	mA
V_{ESD1}	Electrostatic discharge ($R = 1.5$ K Ω , $C = 100$ pF):		
	– Drain – Supply, status, input	5000 4000	V
V_{ESD2}	Electrostatic discharge on output pins only ($R = 330$ Ω , $C = 150$ pF)	2000	V
T_j	Operating junction-temperature	-40 to 150	$^{\circ}$ C
T_{stg}	Storage temperature	-55 to 150	$^{\circ}$ C

2.2 Thermal data

Table 5. Thermal data

Symbol	Parameter	Max. value	Unit
$R_{thj-leadHS}$	Thermal resistance junction-case (high-side switch)	22	$^{\circ}$ C/W
$R_{thj-leadLS}$	Thermal resistance junction-case (low-side switch)	21	$^{\circ}$ C/W
$R_{thj-amb}$	Thermal resistance junction-ambient (high-side switch)	47	$^{\circ}$ C/W
	Thermal resistance junction-ambient (low-side switch)	57	$^{\circ}$ C/W

2.3 Electrical characteristics

2.3.1 Electrical characteristics for dual high-side switches

Values specified in this section are for $8\text{ V} < V_{CC} < 36\text{ V}$; $-40\text{ }^{\circ}\text{C} < T_j < 150\text{ }^{\circ}\text{C}$, unless otherwise specified (for each channel).

Table 6. Power section

Symbol	Parameter	Test conditions	Min.	Typ.	Max.	Unit
V_{CC}	Operating supply voltage		4.5	13	36	V
V_{USD}	Undervoltage shutdown			3.5	4.5	V
$V_{USDhyst}$	Undervoltage shutdown hysteresis			0.5		V
R_{ON}	On-state resistance	$I_{OUT} = 3\text{ A}$; $T_j = 25\text{ }^{\circ}\text{C}$			50	m Ω
		$I_{OUT} = 3\text{ A}$; $T_j = 150\text{ }^{\circ}\text{C}$			100	
		$I_{OUT} = 3\text{ A}$; $V_{CC} = 5\text{ V}$; $T_j = 25\text{ }^{\circ}\text{C}$			65	
V_{clamp}	Voltage clamp	$I_S = 20\text{ mA}$	41	46	52	V
I_S	Supply current	Off-state: $V_{CC} = 13\text{ V}$; $T_j = 25\text{ }^{\circ}\text{C}$, $V_{IN} = V_{OUT} = V_{SENSE} = 0\text{ V}$		2 ⁽¹⁾	5 ⁽¹⁾	μA
		On-state: $V_{CC} = 13\text{ V}$; $V_{IN} = 5\text{ V}$, $I_{OUT} = 0\text{ A}$		3	6	mA
$I_{L(off)}$	Off-state output current ⁽²⁾	$V_{IN} = V_{OUT} = 0\text{ V}$; $V_{CC} = 13\text{ V}$, $T_j = 25\text{ }^{\circ}\text{C}$	0	0.01	3	μA
		$V_{IN} = V_{OUT} = 0\text{ V}$; $V_{CC} = 13\text{ V}$, $T_j = 125\text{ }^{\circ}\text{C}$	0		5	
V_F	Output - V_{CC} diode voltage ⁽²⁾	$I_{OUT} = 3\text{ A}$, $T_j = 150\text{ }^{\circ}\text{C}$			0.7	V

1. PowerMOS leakage included.

2. For each channel.

Table 7. Switching ($V_{CC} = 13\text{ V}$)

Symbol	Parameter	Test conditions	Min.	Typ.	Max.	Unit
$t_{d(on)}$	Turn-on delay time	$R_L = 6.5\text{ }\Omega$ (see Figure 4)	—	25	—	μs
$t_{d(off)}$	Turn-off delay time	$R_L = 6.5\text{ }\Omega$ (see Figure 4)	—	20	—	μs
$(dV_{OUT}/dt)_{on}$	Turn-on voltage slope	$R_L = 6.5\text{ }\Omega$	—	See Figure 15	—	V/ μs
$(dV_{OUT}/dt)_{off}$	Turn-off voltage slope	$R_L = 6.5\text{ }\Omega$	—	See Figure 17	—	V/ μs

Table 7. Switching ($V_{CC} = 13\text{ V}$) (continued)

Symbol	Parameter	Test conditions	Min.	Typ.	Max.	Unit
W_{ON}	Switching energy losses during t_{won}	$R_L = 6.5\ \Omega$ (see Figure 4)	—	0.24	—	mJ
W_{OFF}	Switching energy losses during t_{woff}	$R_L = 6.5\ \Omega$ (see Figure 4)	—	0.2	—	mJ

Table 8. Logic inputs

Symbol	Parameter	Test conditions	Min.	Typ.	Max.	Unit
V_{IL}	Low-level input voltage				0.9	V
I_{IL}	Low-level input current	$V_{IN} = 0.9\text{ V}$	1			μA
V_{IH}	High-level input voltage		2.1			V
I_{IH}	High-level input current	$V_{IN} = 2.1\text{ V}$			10	μA
$V_{I(hyst)}$	Input voltage hysteresis		0.25			V
V_{ICL}	Input voltage clamp	$I_{IN} = 1\text{ mA}$	5.5		7	V
		$I_{IN} = -1\text{ mA}$		-0.7		

Table 9. Protection and diagnostics

Symbol	Parameter	Test conditions ⁽¹⁾	Min.	Typ.	Max.	Unit
I_{limH}	DC short-circuit current	$V_{CC} = 13\text{ V}$	12	18	24	A
		$5\text{ V} < V_{CC} < 36\text{ V}$			24	A
I_{limL}	Short-circuit current during thermal cycling	$V_{CC} = 13\text{ V}; T_R < T_j < T_{TSD}$		7		A
T_{TSD}	Shutdown temperature		150	175	200	$^{\circ}\text{C}$
T_R	Reset temperature		$T_{RS} + 1$	$T_{RS} + 5$		$^{\circ}\text{C}$
T_{RS}	Thermal reset of STATUS		135			$^{\circ}\text{C}$
T_{HYST}	Thermal hysteresis ($T_{TSD} - T_R$)			7		$^{\circ}\text{C}$
V_{DEMAG}	Turn-off output voltage clamp	$I_{OUT} = 2\text{ A}; V_{IN} = 0; L = 6\text{ mH}$	$V_{CC} - 41$	$V_{CC} - 46$	$V_{CC} - 52$	V
V_{ON}	Output voltage drop limitation	$I_{OUT} = 0.1\text{ A}, T_j = -40\text{ }^{\circ}\text{C} \text{ to } 150\text{ }^{\circ}\text{C}$ (see Figure 5)		25		mV

1. To ensure long-term reliability under heavy overload or short-circuit conditions, protection and related diagnostic signals must be used together with a proper software strategy. If the device is subjected to abnormal conditions, this software must limit the duration and number of activation cycles.

Table 10. Current sense (8 V < V_{CC} < 16 V)

Symbol	Parameter	Test conditions	Min.	Typ.	Max.	Unit
K ₀	I _{OUT} / I _{SENSE}	I _{OUT} = 0.35 A; V _{SENSE} = 0.5 V; T _j = -40 °C to 50 °C	1430	2140	2890	
K ₁	I _{OUT} / I _{SENSE}	I _{OUT} = 1 A; V _{SENSE} = 0.5 V; T _j = -40 °C to 150 °C T _j = 25 °C to 150 °C	1470 1570	2020 2020	2610 2470	
K ₂	I _{OUT} / I _{SENSE}	I _{OUT} = 2 A; V _{SENSE} = 4 V; T _j = -40 °C to 150 °C T _j = 25 °C to 150 °C	1740 1790	2020 2020	2320 2250	
K ₃	I _{OUT} / I _{SENSE}	I _{OUT} = 6 A; V _{SENSE} = 4 V; T _j = -40 °C to 150 °C T _j = 25 °C to 150 °C	1890 1890	2010 2010	2140 2140	
V _{SENSE}	Max analog sense output voltage	I _{OUT} = 4 A;	5			V
I _{SENSE0}	Analog sense leakage current	I _{OUT} = 0 A, V _{SENSE} = 0 V, V _{IN} = 0 V, T _j = -40 °C to 150 °C	0		1	μA
		I _{OUT} = 0 A, V _{SENSE} = 0 V, V _{IN} = 5 V, T _j = -40 °C to 150 °C	0		2	
V _{SENSEH}	Analog sense output voltage in overtemperature condition	V _{CC} = 13 V, R _{SENSE} = 10 KΩ		9		V
I _{SENSEH}	Analog sense output current in overtemperature condition	V _{CC} = 13 V, V _{SENSE} = 5 V		8		mA
t _{DSENSE2H}	Delay response time from rising edge of INPUT pin	V _{SENSE} < 4 V, 0.5 A < I _{OUT} < 4 A, I _{SENSE} = 90% of I _{SENSE} max (see Figure 3)		80	250	μs
t _{DSENSE2L}	Delay response time from falling edge of INPUT pin	V _{SENSE} < 4 V, 0.5 A < I _{OUT} < 4 A, I _{SENSE} = 10% of I _{SENSE} max (see Figure 3)		100	250	μs

Figure 3. Current sense delay characteristics

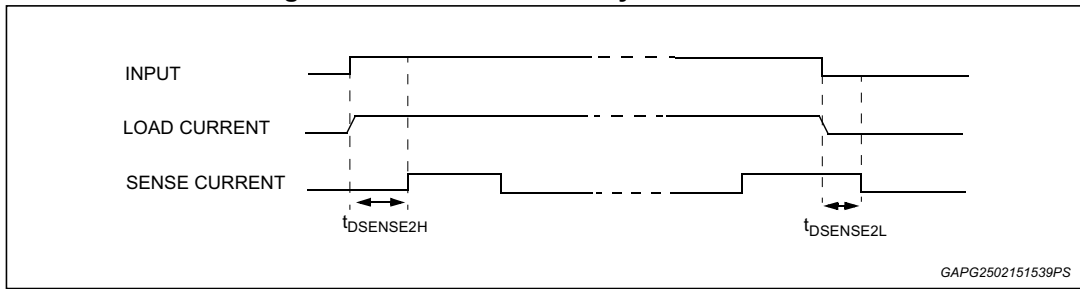

Figure 4. Switching time waveforms

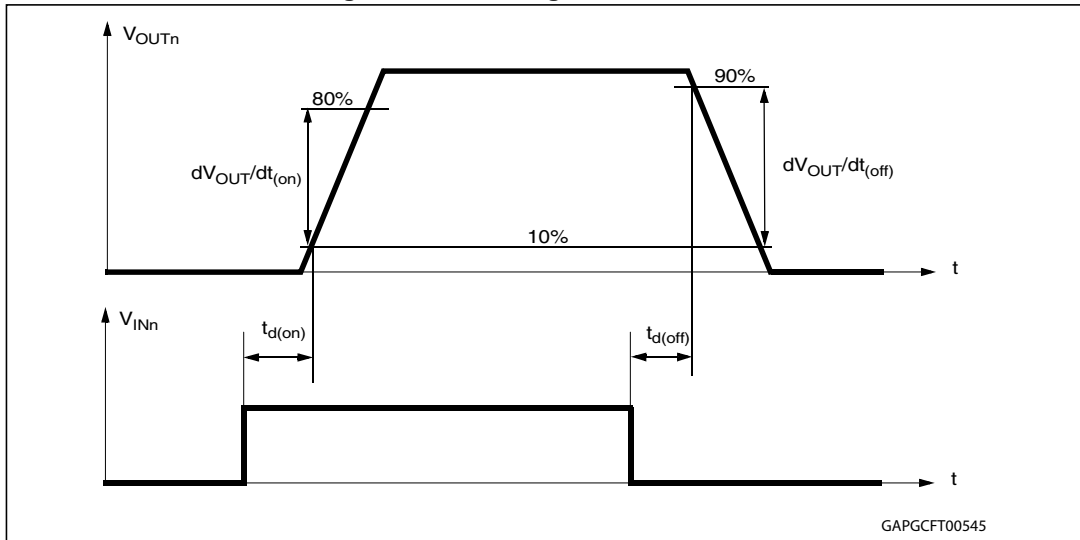

Figure 5. Output voltage drop limitation

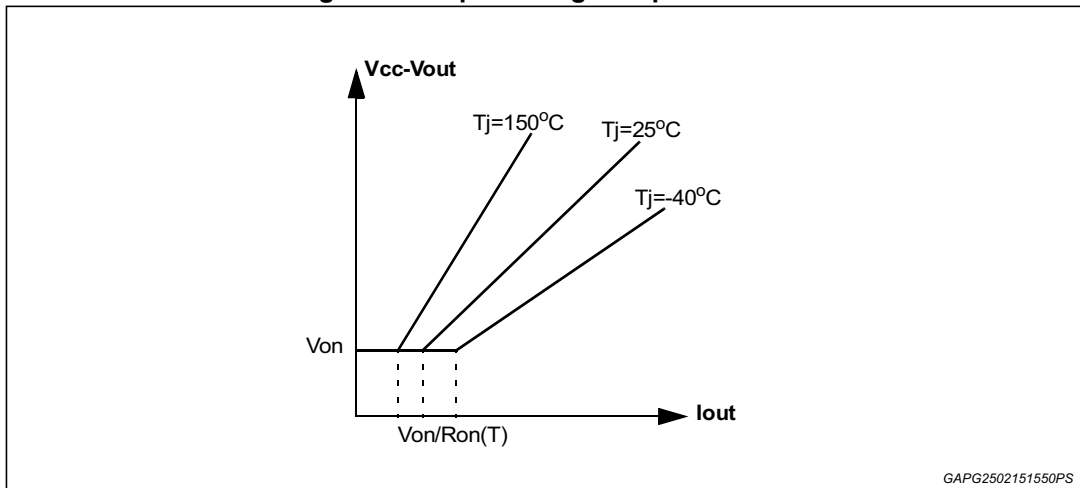

Table 11. Truth table high-side driver

Conditions	Input	Output	Sense
Normal operation	L	L	0
	H	H	Nominal
Overtemperature	L	L	0
	H	L	V_{SENSEH}
Undervoltage	L	L	0
	H	L	0
Short-circuit to GND ($R_{SC} \leq 10 \text{ m}\Omega$)	L	L	0
	H	L	0 if $T_j < T_{TSD}$
	H	L	V_{SENSEH} if $T_j > T_{TSD}$
Short-circuit to V_{CC}	L	H	0
	H	H	< Nominal
Negative output voltage clamp	L	L	0

Table 12. Electrical transient requirements (part 1/3)

ISO 7637-2: 2004(E) test pulse	Test levels ⁽¹⁾		Number of pulses or test times	Burst cycle / pulse repetition time		Delays and Impedance
	III	IV				
1	-75V	-100V	5000 pulses	0.5s	5s	2 ms, 10Ω
2a	+37V	+50V	5000 pulses	0.2s	5s	50μs, 2Ω
3a	-100V	-150V	1h	90ms	100ms	0.1μs, 50Ω
3b	+75V	+100V	1h	90ms	100ms	0.1μs, 50Ω
4	-6V	-7V	1 pulse			100ms, 0.01Ω
5b ⁽²⁾	+65V	+87V	1 pulse			400ms, 2Ω

1. The above test levels must be considered referred to $V_{CC} = 13.5\text{ V}$ except for pulse 5b.
2. Valid in case of external load dump clamp: 40 V maximum referred to ground.

Note: Valid for HSD and H-bridge configuration.

Table 13. Electrical transient requirements (part 2/3)

ISO 7637-2: 2004E test pulse	Test level results ⁽¹⁾	
	III	VI
1	C	C
2a	C	C
3a	C	C
3b	C	C
4	C	C
5b ⁽²⁾	C	C

1. The above test levels must be considered referred to $V_{CC} = 13.5\text{ V}$ except for pulse 5b.
2. Valid in case of external load dump clamp: 40V maximum referred to ground.

Table 14. Electrical transient requirements (part 3/3)

Class	Contents
C	All functions of the device performed as designed after exposure to disturbance.
E	One or more functions of the device are not performed as designed after exposure to disturbance and cannot be returned to proper operation without replacing the device.

2.4 Electrical characteristics curves for dual high-side switches

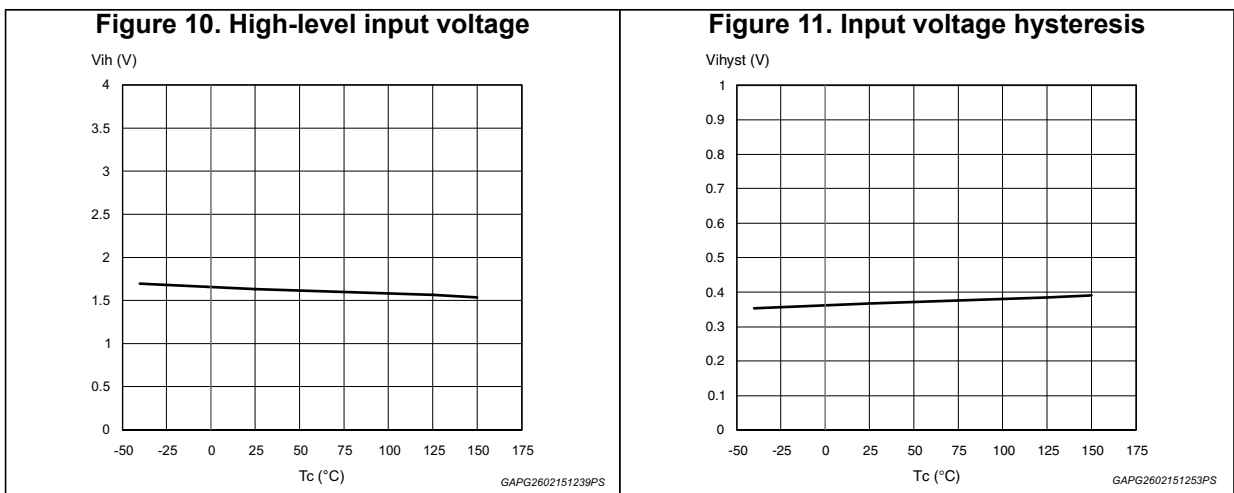
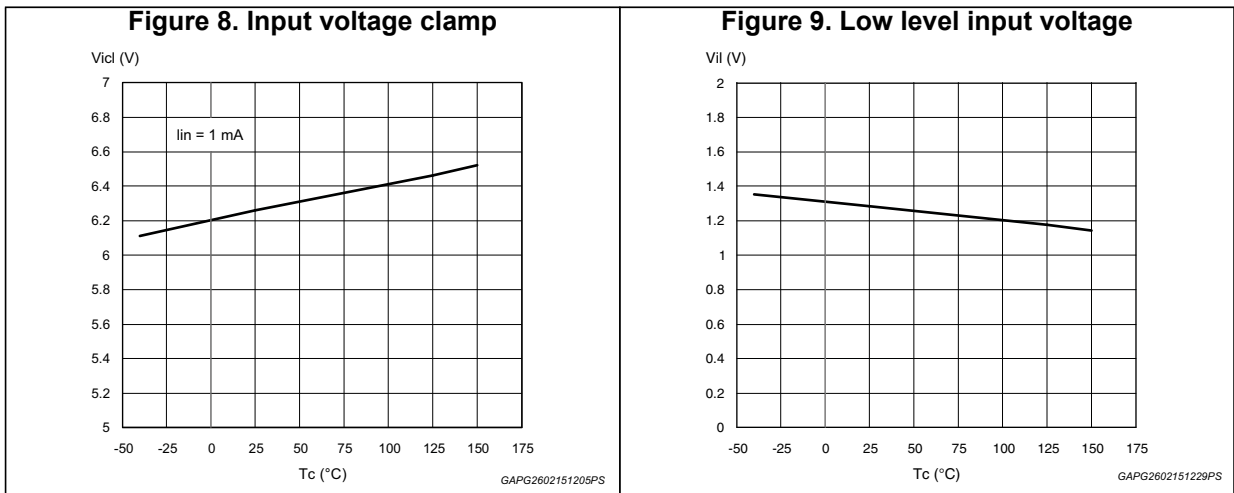
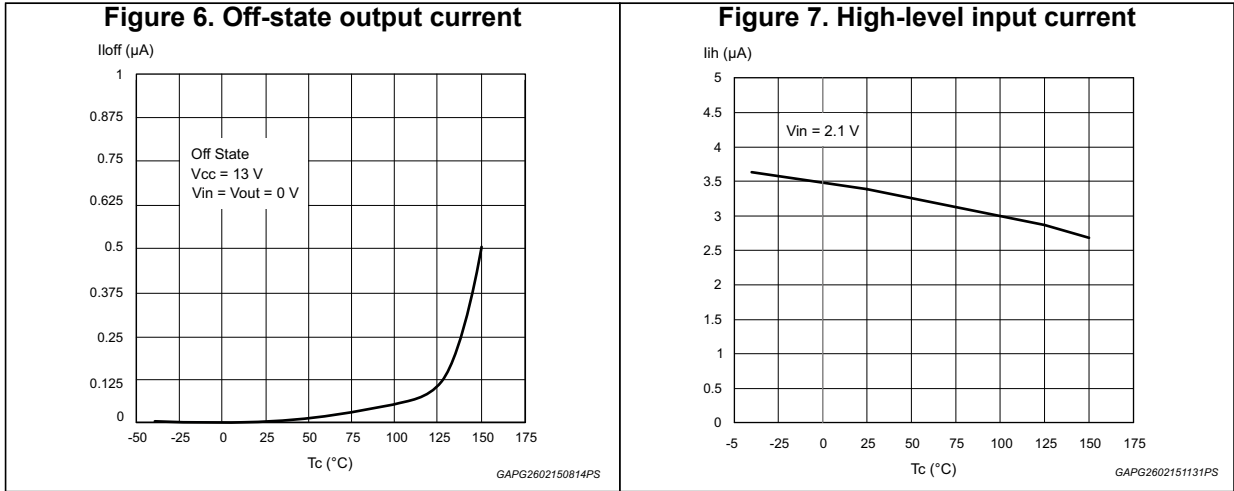

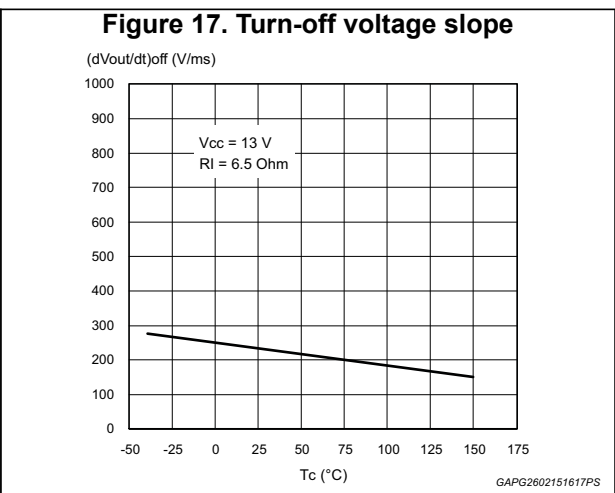
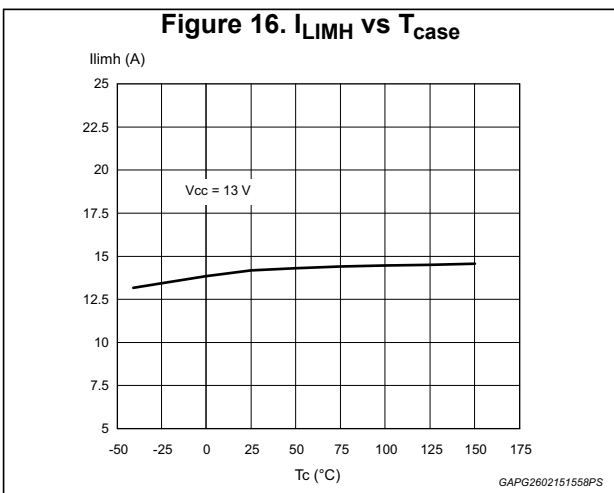
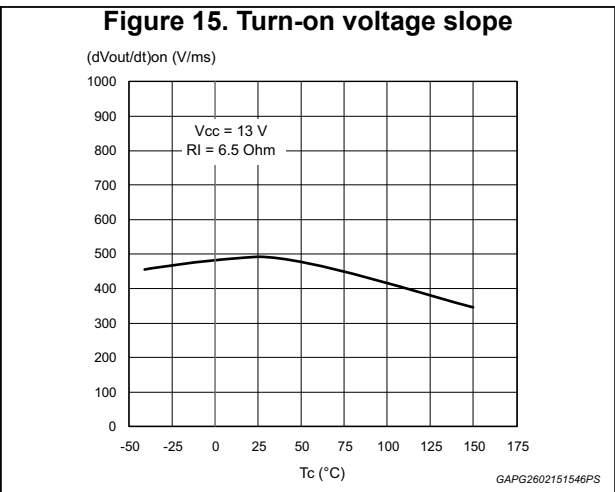
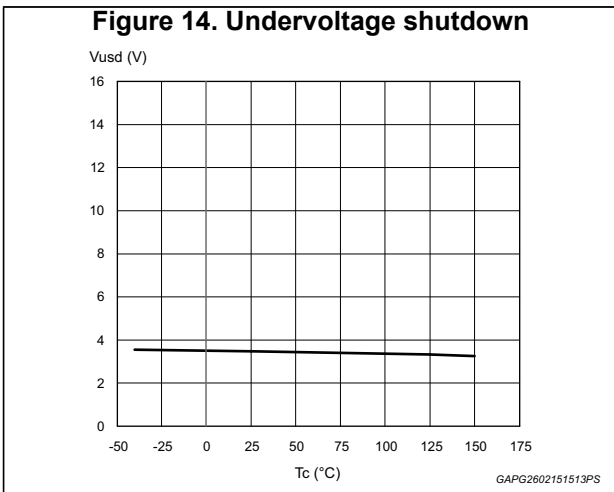
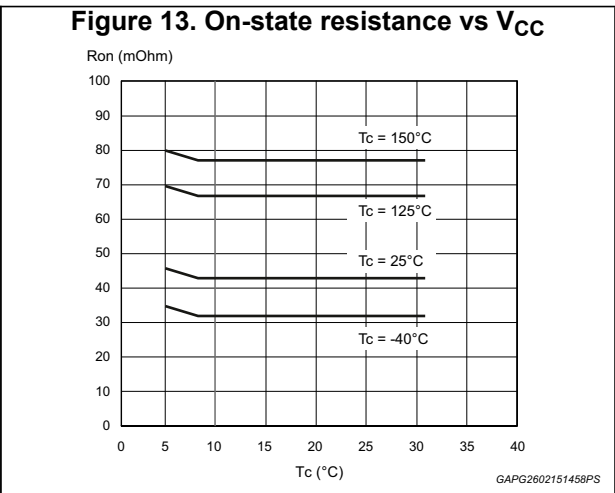
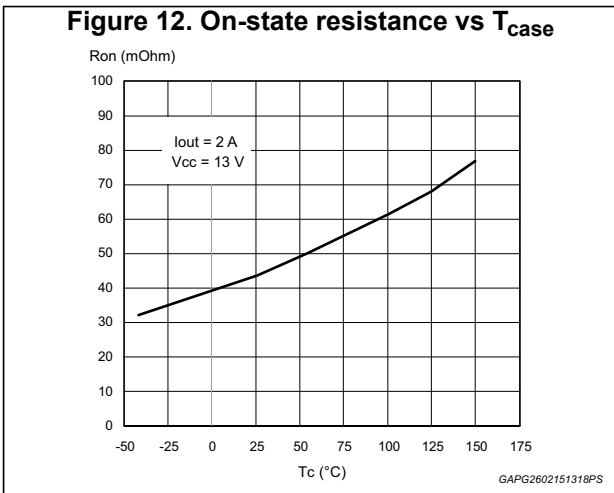

2.5 Electrical characteristics for low-side switch

Values specified in this section are for $-40\text{ °C} < T_j < 150\text{ °C}$, unless otherwise specified

Table 15. PowerMOS section - off

Symbol	Parameter	Test conditions	Min.	Typ.	Max.	Unit
V_{CLAMP}	Drain-source voltage clamp	$V_{IN} = 0\text{ V}; I_D = 2\text{ A}$	41	46	52	V
V_{CLTH}	Drain-source threshold voltage clamp	$V_{IN} = 0\text{ V}; I_D = 2\text{ mA}$	36			V
I_{DSS}	Zero input voltage Drain current ($V_{IN} = 0\text{ V}$)	$V_{DS} = 13\text{ V}; V_{IN} = 0\text{ V}; T_j = 25\text{ °C}$	0		3	μA
		$V_{DS} = 13\text{ V}; V_{IN} = 0\text{ V}; T_j = 125\text{ °C}$	0		5	

Table 16. PowerMOS section - on

Symbol	Parameter	Test conditions	Min.	Typ.	Max.	Unit
$R_{DS(on)}$	Static drain-source on-resistance	$V_{IN} = 5\text{ V}; I_D = 2\text{ A}; T_j = 25\text{ °C}$	—	—	50	$\text{m}\Omega$
		$V_{IN} = 5\text{ V}; I_D = 2\text{ A}; T_j = 150\text{ °C}$	—	—	100	$\text{m}\Omega$

Table 17. Switching ($T_j = 25\text{ °C}$, unless otherwise specified)

Symbol	Parameter	Test conditions	Min.	Typ.	Max.	Unit
$t_{d(on)}$	Turn-on delay time	$R_L = 6.5\ \Omega; V_{CC} = 13\text{ V}$	—	6	—	μs
$t_{d(off)}$	Turn-off delay time	$R_L = 6.5\ \Omega; V_{CC} = 13\text{ V}$	—	20	—	μs
t_r	Turn-on voltage slope	$R_L = 6.5\ \Omega; V_{CC} = 13\text{ V}$	—	10	—	μs
t_f	Turn-off voltage slope	$R_L = 6.5\ \Omega; V_{CC} = 13\text{ V}$	—	10	—	μs
W_{ON}	Switching energy losses during t_{won}	$R_L = 6.5\ \Omega; V_{CC} = 13\text{ V}$	—	0.04	—	mJ
W_{OFF}	Switching energy losses during t_{woff}	$R_L = 6.5\ \Omega; V_{CC} = 13\text{ V}$	—	0.06	—	mJ

Table 18. Source drain diode

Symbol	Parameter	Test conditions	Min.	Typ.	Max.	Unit
$V_{SD}^{(1)}$	Forward on voltage	$I_{SD} = 2\text{ A}; V_{IN} = 0\text{ V}$	—	0.8	—	V

1. Pulsed: Pulse duration = 300 μs , duty cycle 1.5%

Table 19. Input section

Symbol	Parameter	Test conditions	Min.	Typ.	Max.	Unit
I_{ISS}	Supply current from input pin	On-state: $V_{IN} = 5\text{ V}; V_{DS} = 0\text{ V}$		30	110	μA

Table 19. Input section (continued)

Symbol	Parameter	Test conditions	Min.	Typ.	Max.	Unit
V _{ICL}	Input voltage clamp	I _S = 1 mA	5.5		7	V
		I _S = -1 mA		-0.7		
V _{INTH}	Input voltage threshold	V _{DS} = V _{IN} ; I _D = 1 mA	1		3.5	V

Table 20. STATUS pin

Symbol	Parameter	Test conditions	Min.	Typ.	Max.	Unit
V _{STAT}	Status low output voltage	I _{STAT} = 1 mA			0.5	V
I _{LSTAT}	Status leakage current	Normal operation, V _{STAT} = 5 V			10	μA
C _{STAT}	STATUS pin input capacitance	Normal operation, V _{STAT} = 5 V			100	pF
V _{STCL}	Status voltage clamp	I _{STAT} = 1 mA	5.5		7	V
		I _{STAT} = -1 mA		-0.7		

Table 21. Protection and diagnostics (-40 °C < T_j < 150 °C, unless otherwise specified)

Symbol	Parameter	Test conditions	Min.	Typ.	Max.	Unit
I _{limH}	DC short-circuit current	V _{DS} = 13 V, V _{IN} = 5 V	19	27	38	A
I _{limL}	Short-circuit current during thermal cycling	V _{DS} = 13 V, T _R < T _j < T _{TSD}		11		A
t _{dlim}	Step response current limit	V _{IN} = 5 V, V _{DS} = 13 V		20		μs
T _{TSD}	Overtemperature shutdown		150	175	200	°C
T _R	Overtemperature reset		135			°C

Table 22. Truth table low-side driver

Conditions	Input	Drain	Status
Normal operation	L	H	H
	H	L	H
Overtemperature	L	H	H
	H	H	L

2.6 Electrical characteristics curves for low-side switch

Figure 18. Source diode forward characteristics

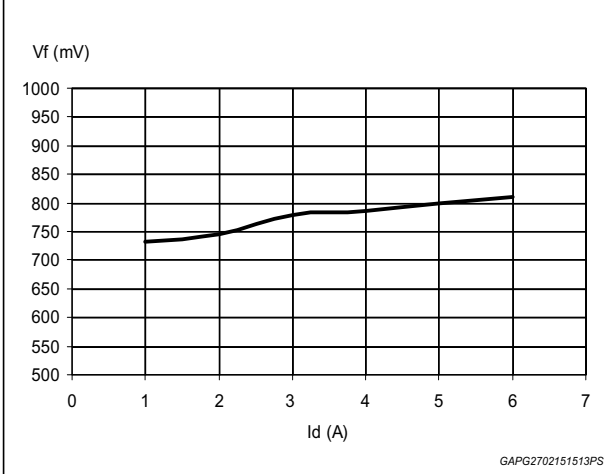

Figure 19. Static drain source on-resistance vs drain current (3 pin)

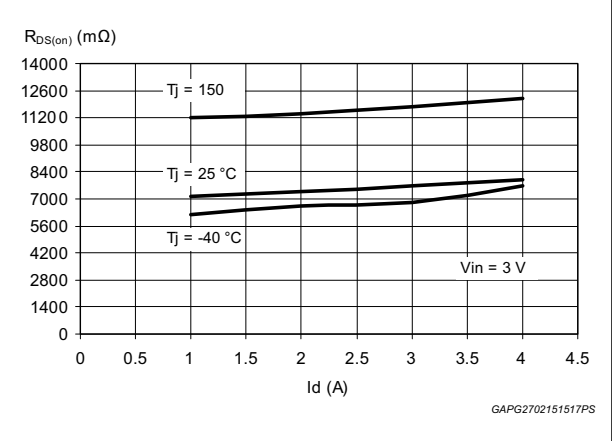

Figure 20. Static drain source on-resistance vs input voltage (3 pin)

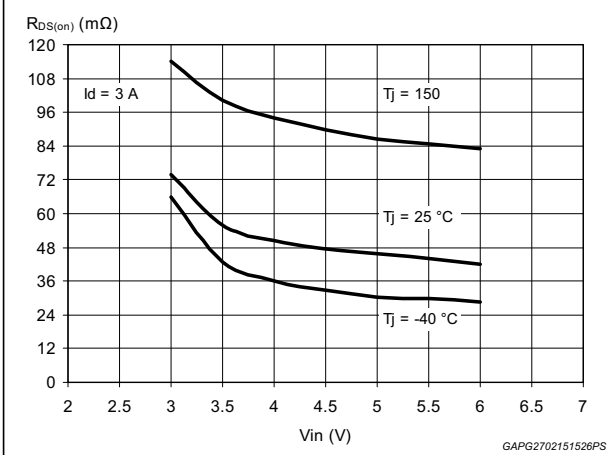

Figure 21. Static drain source on-resistance vs drain current

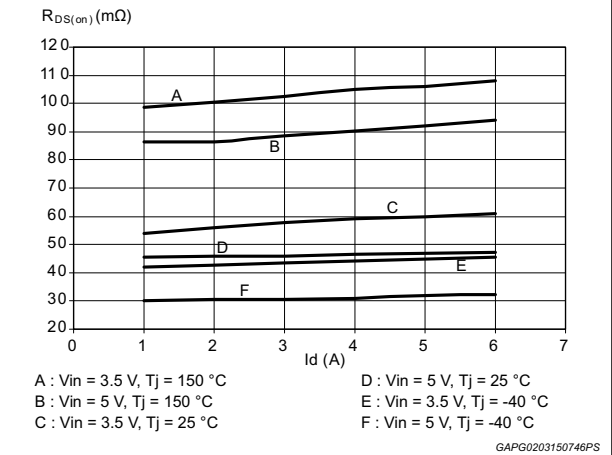

Figure 22. Transfer characteristics

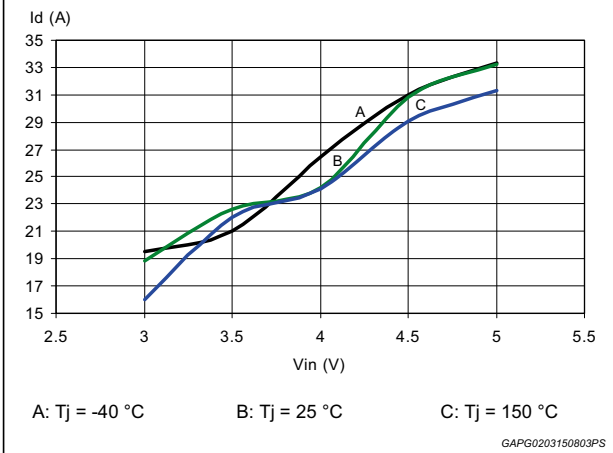

Figure 23. Output characteristics

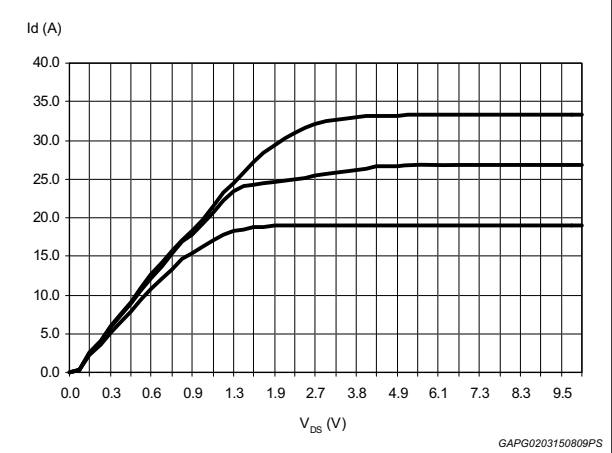

Figure 24. Normalized on-resistance vs temperature

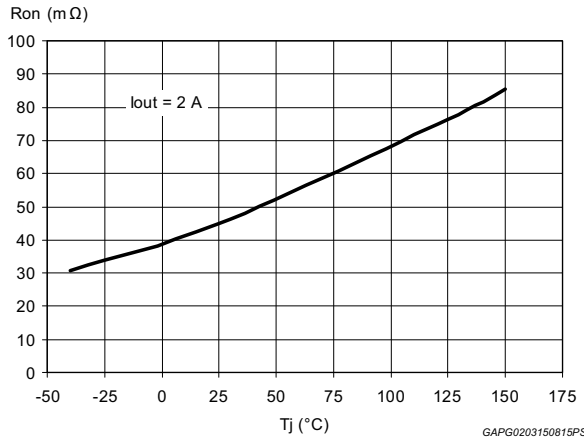
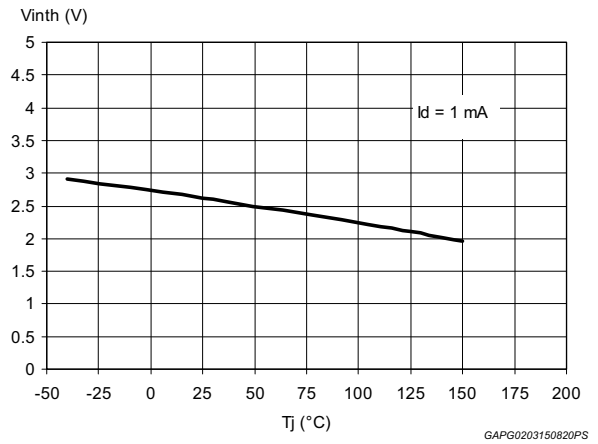
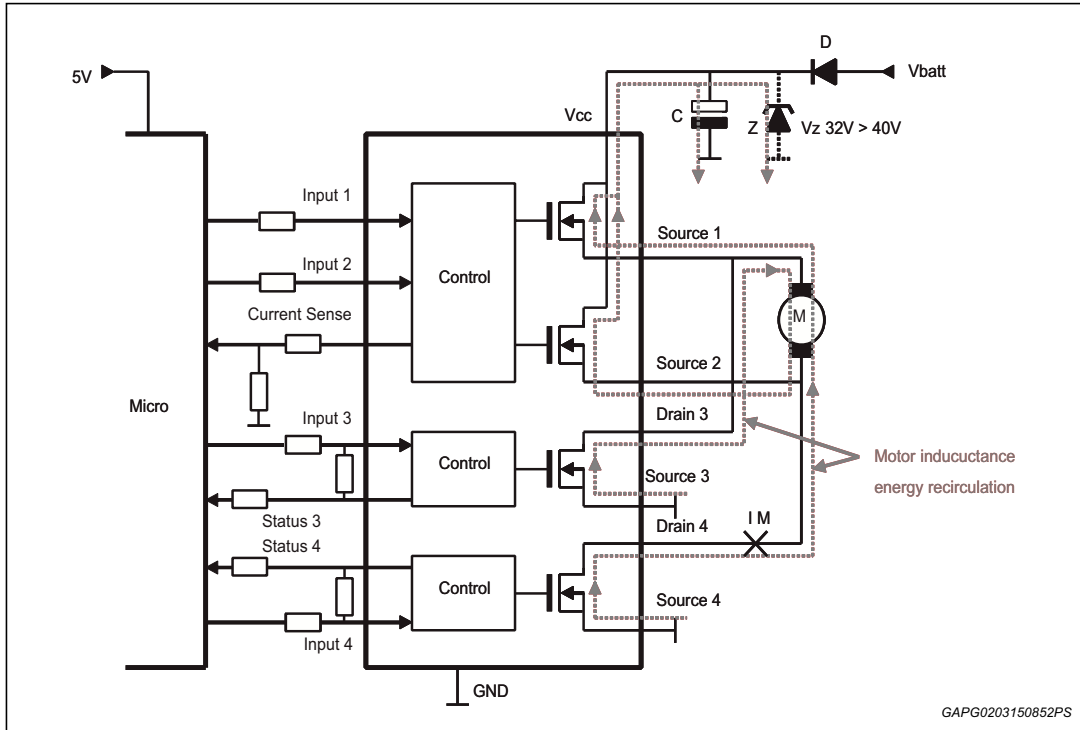

Figure 25. Normalized input threshold vs temperature



3 Application information

Figure 26. Typical application schematic



Mostly motor bridge drivers use a reverse battery protection diode (D) inside supply rail. This diode prevents a reverse current flow back to Vbatt in case the bridge gets disabled via the logic inputs while motor inductance still carries energy. In order to prevent a hazardous overvoltage at circuit supply terminal (V_{CC}), a blocking capacitor (C) is needed to limit the voltage overshoot. As basic orientation, 50 μ F per 1 A load current is recommended. In alternative, also a Zener protection (Z) is suitable.

Even if a reverse polarity diode is not present, it is recommended to use a capacitor or zener at V_{CC} because a similar problem appears in case supply terminal of the module has intermittent electrical contact to the battery or gets disconnected while motor is operating.

Figure 27. Recommended motor operation

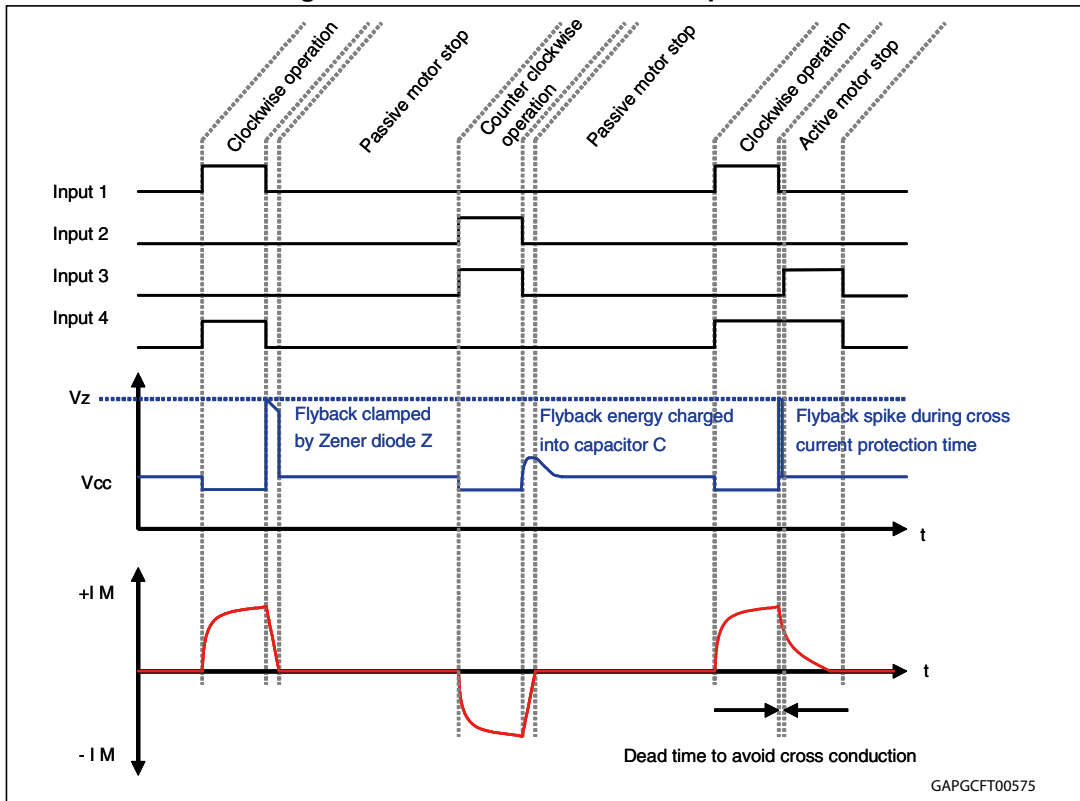

GAPGCF00575

Figure 28. Waveforms (high-side switches)

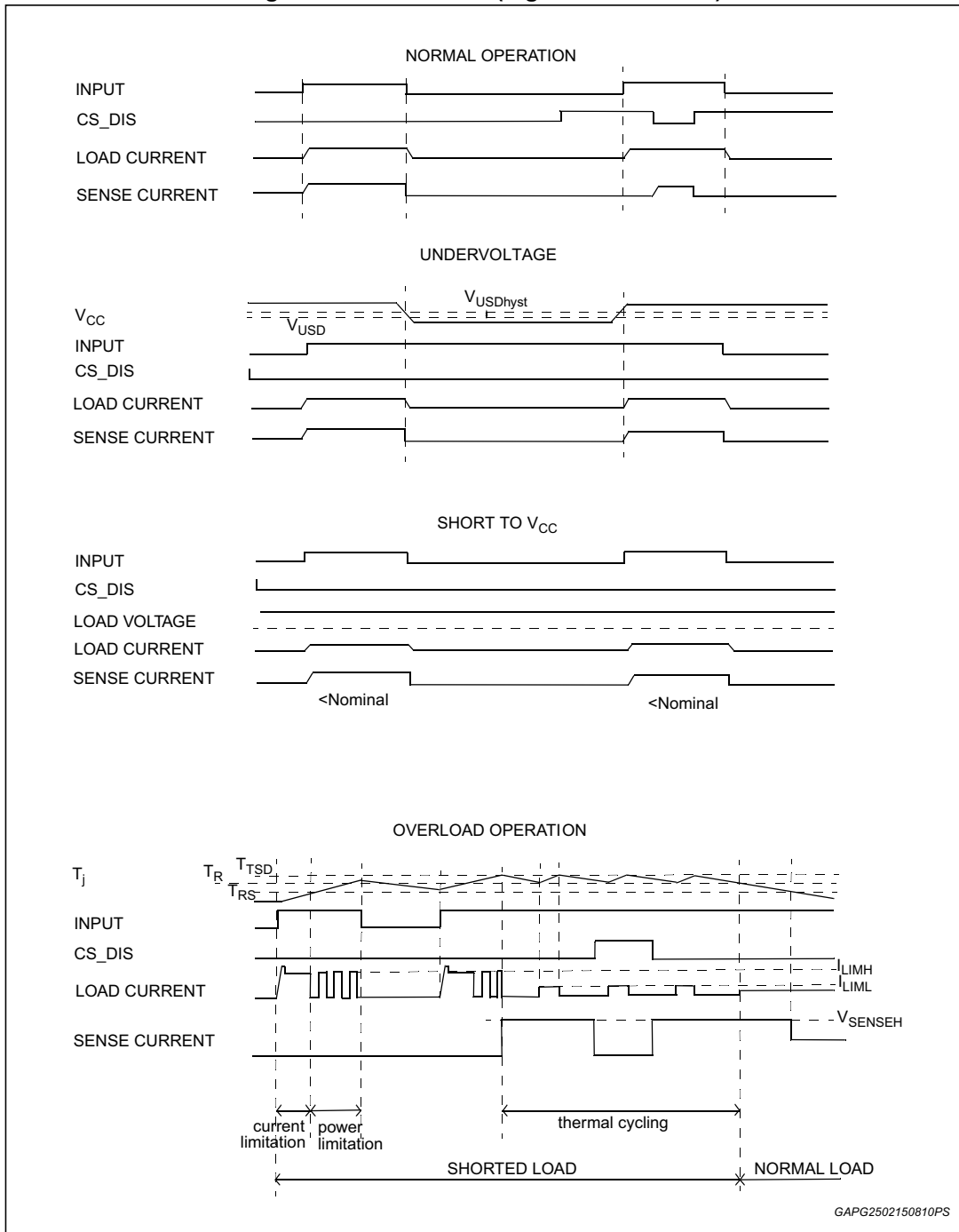

3.1 Maximum demagnetization energy ($V_{CC} = 13.5\text{ V}$)

Figure 29. Maximum turn-off current vs load inductance

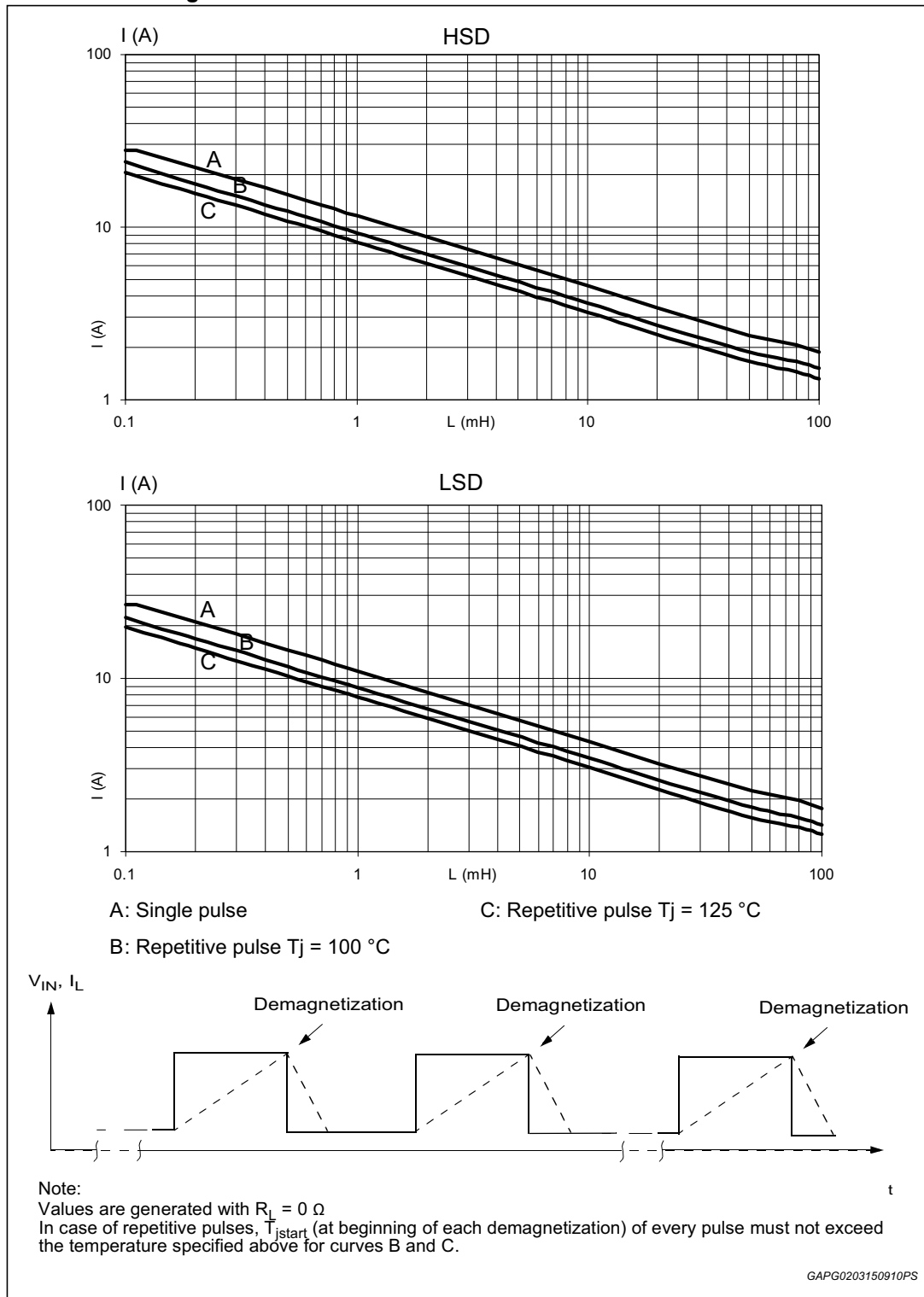

4 Package and PC board thermal data

4.1 SO-28 thermal data

Figure 30. SO-28 PC board

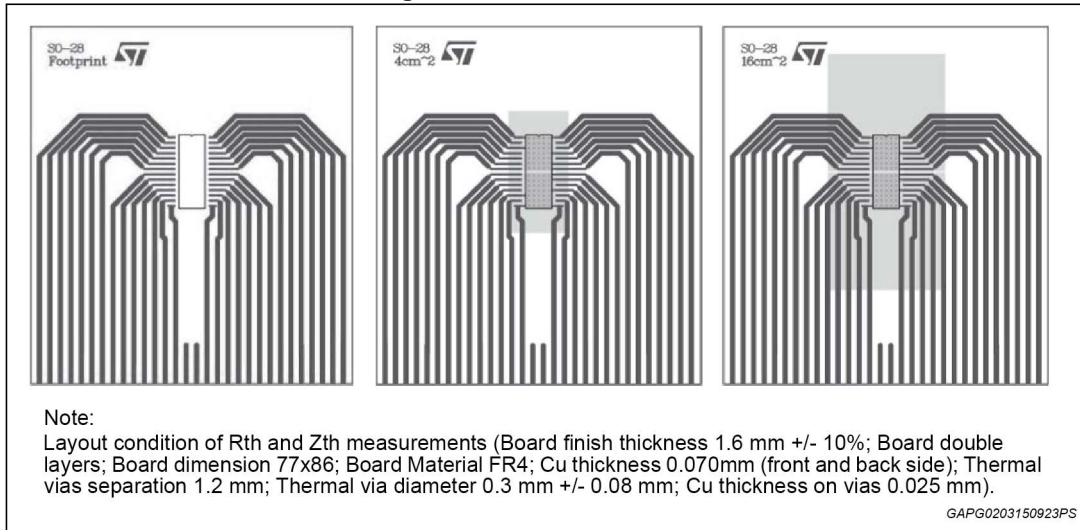

Figure 31. Chipset configuration

