



Chipsmall Limited consists of a professional team with an average of over 10 year of expertise in the distribution of electronic components. Based in Hongkong, we have already established firm and mutual-benefit business relationships with customers from,Europe,America and south Asia,supplying obsolete and hard-to-find components to meet their specific needs.

With the principle of “Quality Parts,Customers Priority,Honest Operation,and Considerate Service”,our business mainly focus on the distribution of electronic components. Line cards we deal with include Microchip,ALPS,ROHM,Xilinx,Pulse,ON,Everlight and Freescale. Main products comprise IC,Modules,Potentiometer,IC Socket,Relay,Connector.Our parts cover such applications as commercial,industrial, and automotives areas.

We are looking forward to setting up business relationship with you and hope to provide you with the best service and solution. Let us make a better world for our industry!



Contact us

Tel: +86-755-8981 8866 Fax: +86-755-8427 6832

Email & Skype: info@chipsmall.com Web: www.chipsmall.com

Address: A1208, Overseas Decoration Building, #122 Zhenhua RD., Futian, Shenzhen, China



Optocoupler, Phototransistor Output, High Reliability, 5300 V_{RMS}

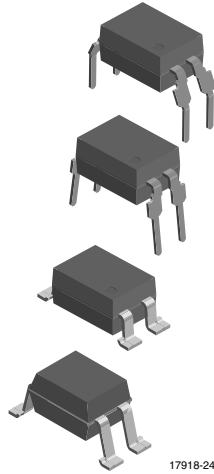

17918-24

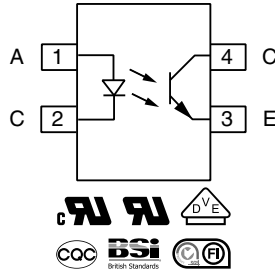

FEATURES

- Operating temperature from -55 °C to +110 °C
- Good CTR linearity depending on forward current
- Isolation test voltage, 5300 V_{RMS}
- High collector emitter voltage, V_{CEO} = 80 V
- Low saturation voltage
- Fast switching times
- Low CTR degradation
- Temperature stable
- Low coupling capacitance
- End stackable, 0.100" (2.54 mm) spacing
- High common mode interference immunity
- Material categorization: for definitions of compliance please see www.vishay.com/doc?99912



APPLICATIONS

- AC adapters
- SMPS
- PLC
- Factory automation
- Game consoles

AGENCY APPROVALS

Safety application model number covering all products in this data sheet is VO617A. This model number should be used when consulting safety agency documents.

- UL1577, file no. E52744
- cUL tested to CSA 22.2 bulletin 5A
- DIN EN 60747-5-5 (VDE 0884-5), available with option 1
- BSI IEC 60950; IEC 60065
- FIMKO EN 60065, EN 60950-1
- CQC GB8898-2011

DESCRIPTION

The 110 °C rated VO617A feature a high current transfer ratio, low coupling capacitance and high isolation voltage. These couplers have a GaAs infrared diode emitter, which is optically coupled to a silicon planar phototransistor detector, and is incorporated in a plastic DIP-4 package.

The coupling devices are designed for signal transmission between two electrically separated circuits.

The couplers are end-stackable with 2.54 mm spacing.

Creepage and clearance distances of > 8.0 mm are achieved with option 6. This version complies with IEC 60950 (DIN VDE 0805) for reinforced insulation up to an operation voltage of 400 V_{RMS} or DC. Specifications subject to change.

ORDERING INFORMATION

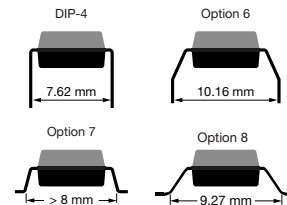
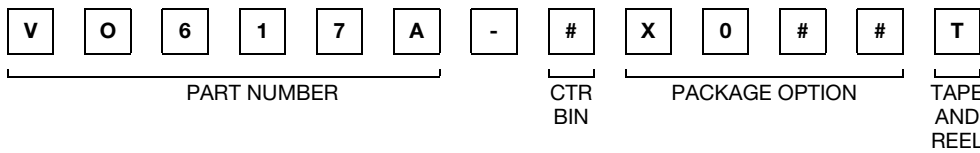

AGENCY CERTIFIED/PACKAGE	CTR (%)							
	5 mA							
UL, cUL, BSI, FIMKO	50 to 600	40 to 80	63 to 125	100 to 200	160 to 320	80 to 160	130 to 260	200 to 400
DIP-4	VO617A	VO617A-1	VO617A-2	VO617A-3	VO617A-4	VO617A-7	VO617A-8	VO617A-9
DIP-4, 400 mil, option 6	-	-	-	VO617A-3X006	VO617A-4X006	-	-	-
SMD-4, option 7	-	-	VO617A-2X007T	VO617A-3X007T	VO617A-4X007T	-	-	-
VDE, UL, cUL, BSI, FIMKO	50 to 600	40 to 80	63 to 125	100 to 200	160 to 320	80 to 160	130 to 260	200 to 400
DIP-4, 400 mil, option 6	-	-	-	VO617A-3X016	VO617A-4X016	VO617A-7X016	VO617A-8X016	VO617A-9X016
SMD-4, option 7	-	VO617A-1X017T	VO617A-2X017T	VO617A-3X017T	VO617A-4X017T	VO617A-7X017T	VO617A-8X017T	VO617A-9X017T
SMD-4, 400 mil, option 8	-	-	-	VO617A-3X018T	-	-	-	-

Note

- Additional options may be possible, please contact sales office.

ABSOLUTE MAXIMUM RATINGS ($T_{amb} = 25\text{ }^{\circ}\text{C}$, unless otherwise specified)				
PARAMETER	CONDITIONS	SYMBOL	VALUE	UNIT
INPUT				
Reverse voltage		V_R	6	V
Forward current		I_F	60	mA
Forward surge current	$t_p \leq 10\text{ }\mu\text{s}$	I_{FSM}	1.5	A
LED power dissipation		P_{diss}	70	mW
OUTPUT				
Collector emitter voltage		V_{CEO}	80	V
Emitter collector voltage		V_{ECO}	7	V
Collector current		I_C	50	mA
Collector peak current	$t_p/T = 0.5, t_p \leq 10\text{ ms}$	I_{CM}	100	mA
Ouput power dissipation		P_{diss}	150	mW
COUPLER				
Total power dissipation		P_{tot}	200	mW
Operation temperature		T_{amb}	-55 to +110	$^{\circ}\text{C}$
Storage temperature range		T_{stg}	-55 to +150	$^{\circ}\text{C}$
Soldering temperature	2 mm from case, $\leq 10\text{ s}$	T_{sld}	260	$^{\circ}\text{C}$

Notes

- Stresses in excess of the absolute maximum ratings can cause permanent damage to the device. Functional operation of the device is not implied at these or any other conditions in excess of those given in the operational sections of this document. Exposure to absolute maximum ratings for extended periods of the time can adversely affect reliability.

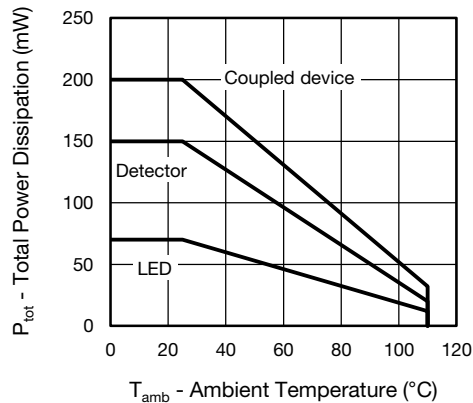

Fig. 1 - Total Power Dissipation vs. Ambient Temperature



ELECTRICAL CHARACTERISTICS ($T_{amb} = 25\text{ }^{\circ}\text{C}$, unless otherwise specified)							
PARAMETER	TEST CONDITION	PART	SYMBOL	MIN.	TYP.	MAX.	UNIT
INPUT							
Forward voltage	$I_F = 60\text{ mA}$		V_F	1	1.35	1.65	V
Reverse current	$V_R = 6\text{ V}$		I_R		0.01	10	μA
Junction capacitance	$V_R = 0\text{ V}$, $f = 1\text{ MHz}$		C_j		13		pF
OUTPUT							
Collector emitter leakage current	$V_{CE} = 10\text{ V}$	VO617A-1	I_{CEO}		2	50	nA
		VO617A-2			2	50	
		VO617A-3			5	100	
		VO617A-4			5	100	
		VO617A-7			5	100	
		VO617A-8			5	100	
		VO617A-9			5	100	
Collector emitter capacitance	$V_{CE} = 5\text{ V}$, $f = 1\text{ MHz}$		C_{CE}		5.2		pF
Collector emitter breakdown voltage	$I_C = 1\text{ mA}$		BV_{CEO}	80			V
Emitter collector breakdown voltage	$I_E = 100\text{ }\mu\text{A}$		BV_{ECO}	7			V
COUPLER							
Collector emitter saturation voltage	$I_F = 5\text{ mA}$, $I_C = 1.0\text{ mA}$		V_{CEsat}		0.25	0.4	V
Coupling capacitance	$f = 1\text{ MHz}$		C_C		0.4		pF

Note

- Minimum and maximum values are testing requirements. Typical values are characteristics of the device and are the result of engineering evaluation. Typical values are for information only and are not part of the testing requirements.

CURRENT TRANSFER RATIO ($T_{amb} = 25\text{ }^{\circ}\text{C}$, unless otherwise specified)							
PARAMETER	TEST CONDITION	PART	SYMBOL	MIN.	TYP.	MAX.	UNIT
I_C/I_F	$I_F = 5\text{ mA}$, $V_{CE} = 5\text{ V}$	VO617A	CTR	50		600	%
		VO617A-1	CTR	40		80	%
		VO617A-2	CTR	63		125	%
		VO617A-3	CTR	100		200	%
		VO617A-4	CTR	160		320	%
		VO617A-7	CTR	80		160	%
		VO617A-8	CTR	130		260	%
		VO617A-9	CTR	200		400	%

SWITCHING CHARACTERISTICS ($T_{amb} = 25\text{ }^{\circ}\text{C}$, unless otherwise specified)							
PARAMETER	TEST CONDITION	CTR BIN	SYMBOL	MIN.	TYP.	MAX.	UNIT
NON-SATURATED							
Rise and fall time	$I_F = 5\text{ mA}$, $V_{CC} = 5\text{ V}$, $R_L = 75\text{ }\Omega$		t_r , t_f		2		μs
Turn-on time	$I_F = 5\text{ mA}$, $V_{CC} = 5\text{ V}$, $R_L = 75\text{ }\Omega$		t_{on}		3		μs
Turn-off time			t_{off}		2.3		μs
Cut-off frequency	$I_F = 5\text{ mA}$, $V_{CC} = 5\text{ V}$, $R_L = 75\text{ }\Omega$		f_{ctr}		190		kHz
SATURATED							
Turn-on time	$I_F = 5\text{ mA}$		t_{on}		6		μs
Turn-off time	$I_F = 5\text{ mA}$		t_{off}		25		μs
Rise time	$I_F = 5\text{ mA}$		t_r		4.6		μs
Fall time	$I_F = 5\text{ mA}$		t_f		15		μs

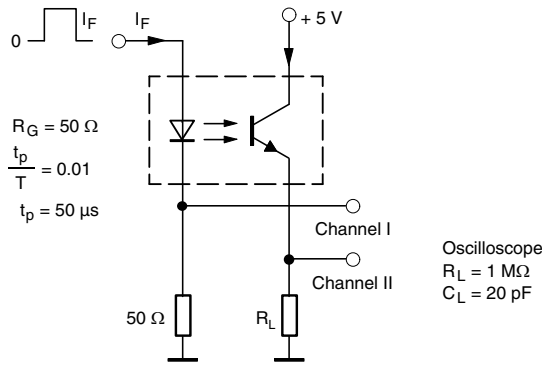

95 10804-3

Fig. 2 - Test Circuit, Non-Saturated Operation

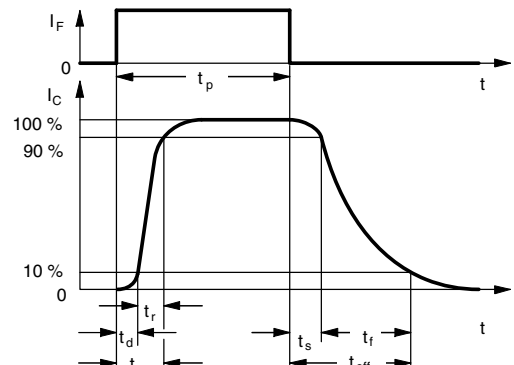

t_p Pulse duration
 t_d Delay time
 t_r Rise time
 $t_{on} (= t_d + t_r)$ Turn-on time
 t_s Storage time
 t_f Fall time
 $t_{off} (= t_s + t_f)$ Turn-off time

Fig. 4 - Switching Times

96 11698

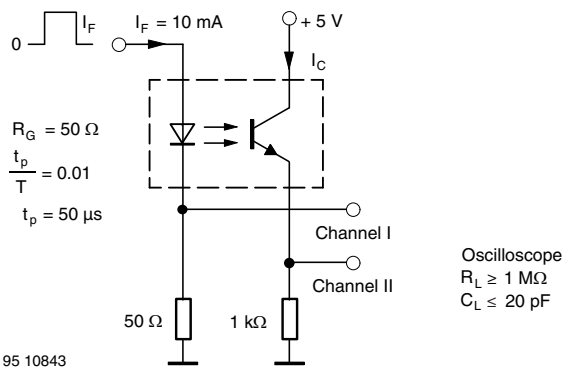

95 10843

Fig. 3 - Test Circuit, Saturated Operation

SAFETY AND INSULATION RATINGS

PARAMETER	TEST CONDITION	SYMBOL	VALUE	UNIT
Climatic classification	According to IEC 68 part 1		55/115/21	
Pollution degree	According to DIN VDE 0109		2	
Comparative tracking index	Insulation group IIIa	CTI	175	
Maximum rated withstanding isolation voltage	According to UL1577, $t = 1 \text{ min}$	V_{ISO}	4470	V_{RMS}
Tested withstanding isolation voltage	According to UL1577, $t = 1 \text{ s}$	V_{ISO}	5300	V_{RMS}
Maximum transient isolation voltage	According to DIN EN 60747-5-5	V_{IOTM}	8000	V_{peak}
Maximum repetitive peak isolation voltage	According to DIN EN 60747-5-5	V_{IORM}	890	V_{peak}
Isolation resistance	$T_{amb} = 25 \text{ }^\circ\text{C}$, $V_{IO} = 500 \text{ V}$	R_{IO}	$\geq 10^{12}$	Ω
	$T_{amb} = 100 \text{ }^\circ\text{C}$, $V_{IO} = 500 \text{ V}$	R_{IO}	$\geq 10^{11}$	Ω
Output safety power		P_{SO}	700	mW
Input safety current		I_{SI}	400	mA
Input safety temperature		T_S	175	$^\circ\text{C}$
Creepage distance	DIP-4		≥ 7	mm
Clearance distance	DIP-4		≥ 7	mm
Creepage distance	DIP-4, 400 mil, option 6		≥ 8	mm
Clearance distance	DIP-4, 400 mil, option 6		≥ 8	mm
Creepage distance	SMD-4, option 7		≥ 7	mm
Clearance distance	SMD-4, option 7		≥ 7	mm
Creepage distance	SMD-4, 400 mil, option 8		≥ 8	mm
Clearance distance	SMD-4, 400 mil, option 8		≥ 8	mm
Insulation thickness		DTI	≥ 0.4	mm

Note

- As per DIN EN 60747-5-5, § 7.4.3.8.2, this optocoupler is suitable for "safe electrical insulation" only within the safety ratings. Compliance with the safety ratings shall be ensured by means of protective circuits.

TYPICAL CHARACTERISTICS ($T_{amb} = 25\text{ }^{\circ}\text{C}$, unless otherwise specified)

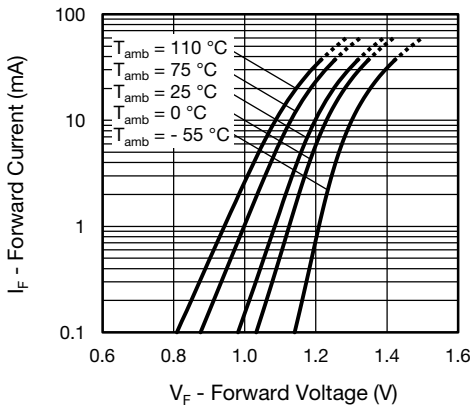

Fig. 5 - Forward Voltage vs. Forward Current

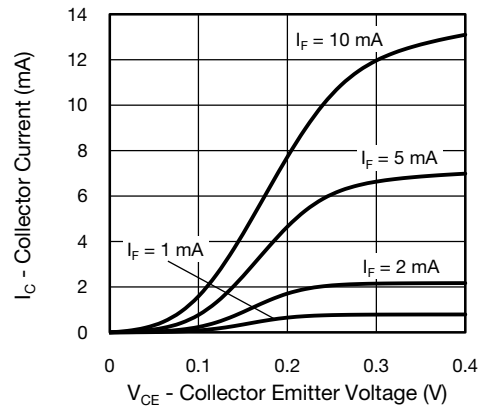

Fig. 8 - Collector Current vs. Collector Emitter Voltage

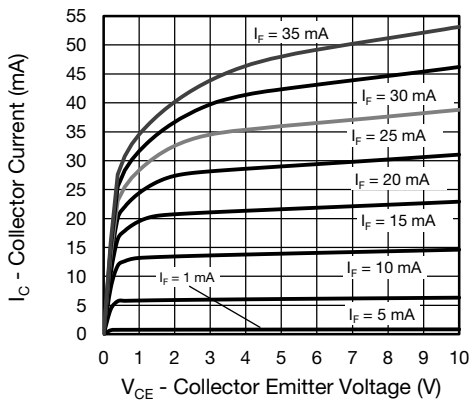

Fig. 6 - Collector Current vs. Collector Emitter Voltage

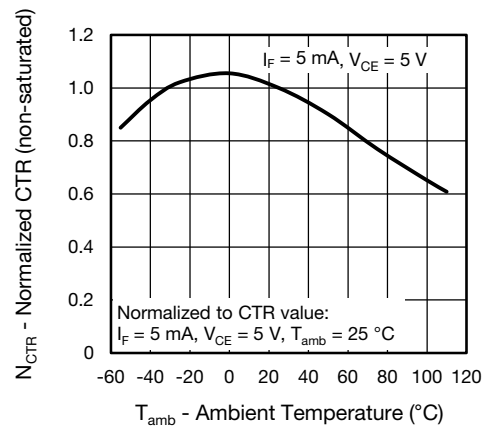

Fig. 9 - Normalized Current Transfer Ratio (non-sat.) vs. Ambient Temperature

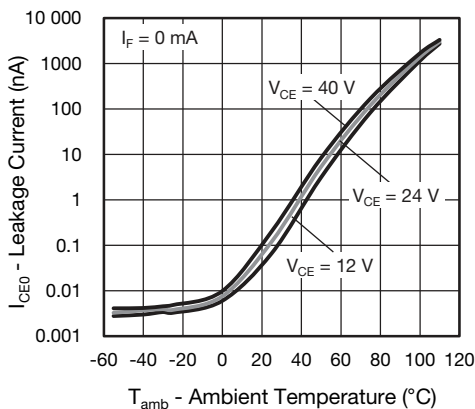

Fig. 7 - Leakage Current vs. Ambient Temperature

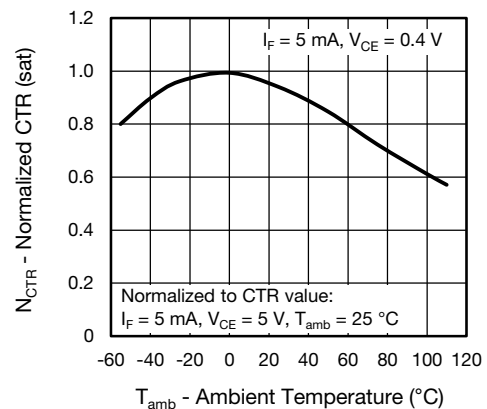

Fig. 10 - Normalized Current Transfer Ratio (sat.) vs. Ambient Temperature

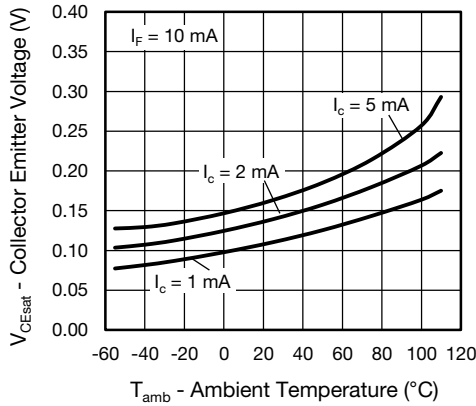

Fig. 11 - Collector Emitter Voltage vs. Ambient Temperature

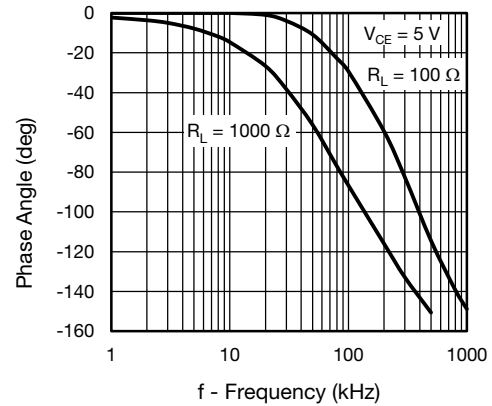

Fig. 14 - Phase Angle vs. Frequency

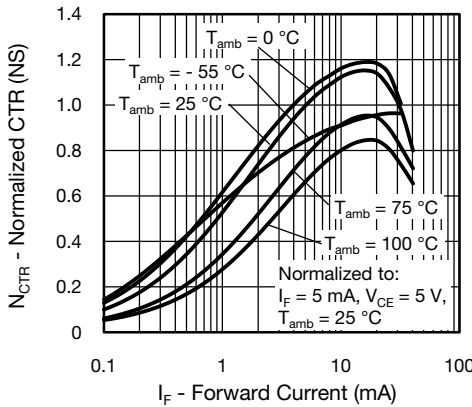

Fig. 12 - Normalized CTR (non-sat.) vs. Forward Current

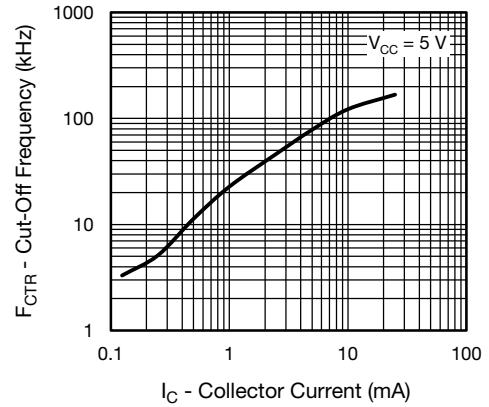

Fig. 15 - Cut-Off Frequency vs. Collector Current

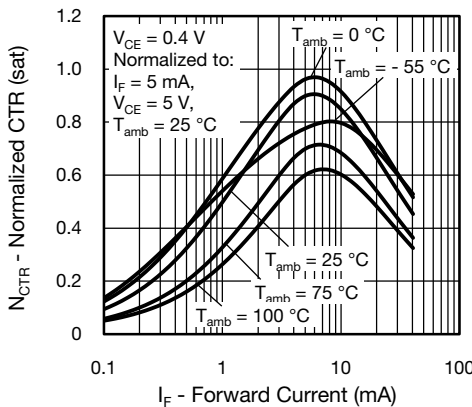

Fig. 13 - Normalized CTR (sat.) vs. Forward Current

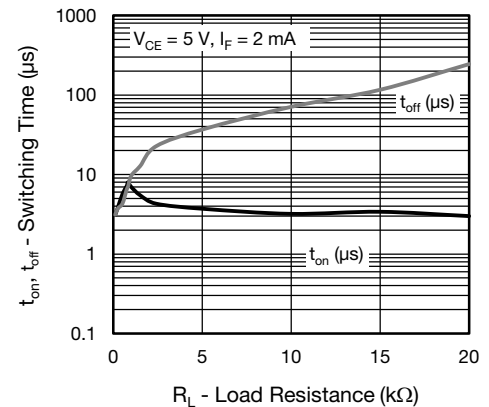

Fig. 16 - Switching Time vs. Load Resistance

PACKAGE DIMENSIONS (in millimeters)

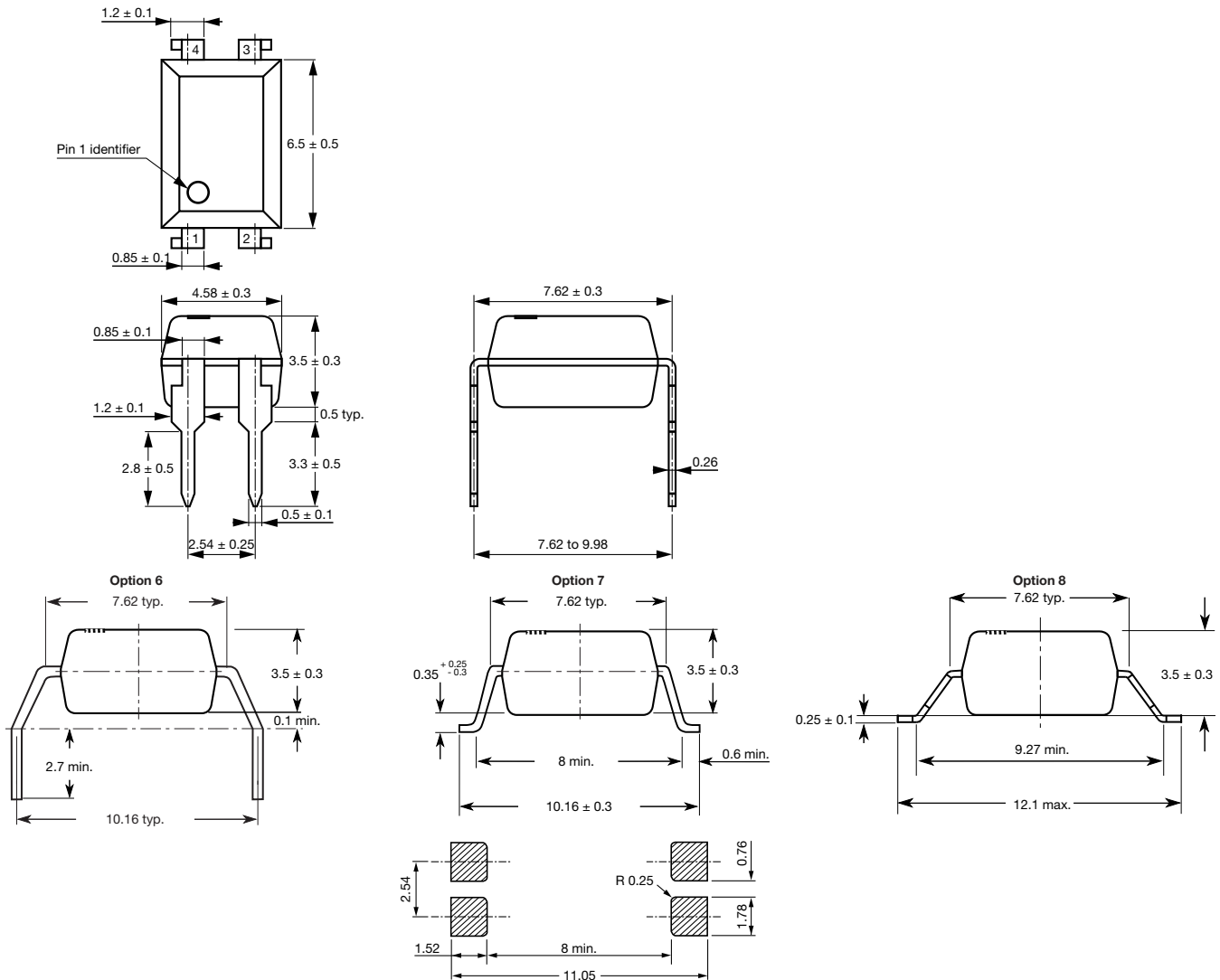

Fig. 17 - Package Drawings

PACKAGE MARKING

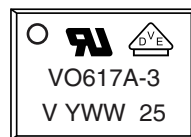

Fig. 18 - Example of VO617A-3X017T

Notes

- The VDE logo is only marked on option 1 parts. Option information is not marked on the part.
- Tape and reel suffix (T) is not part of the package marking.

PACKING INFORMATION

DEVICE PER TUBE			
TYPE	UNITS/TUBE	TUBES/BOX	UNITS/BOX
DIP-4	100	40	4000

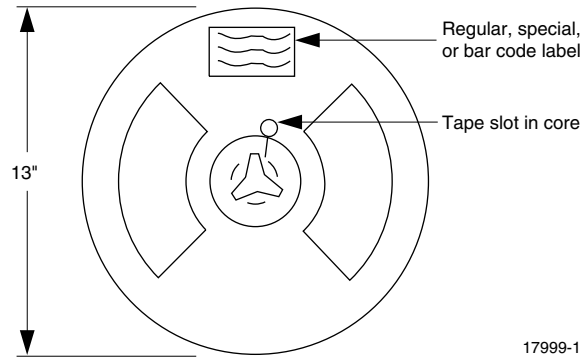

Fig. 19 - Tape and Reel Shipping Medium

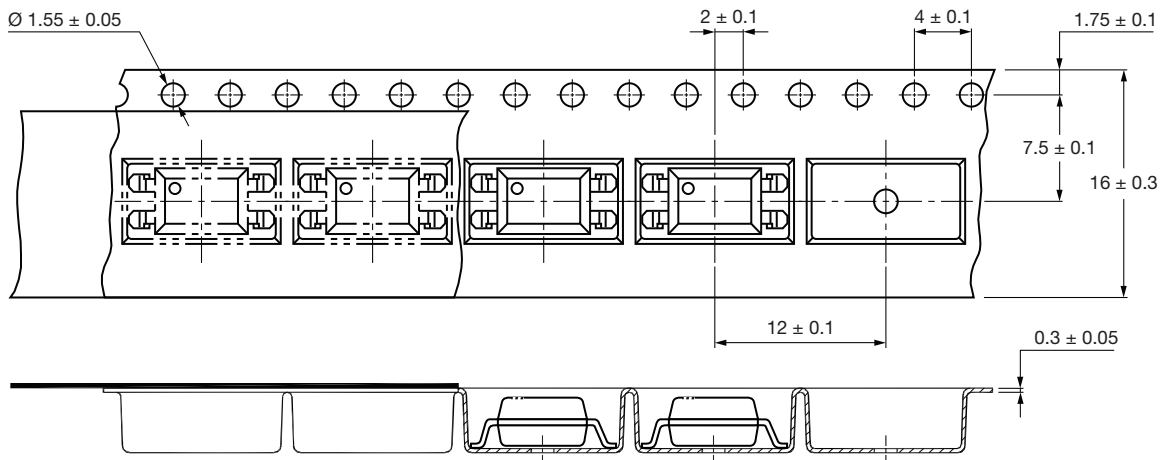

Fig. 20 - Tape and Packing for Option 7 (1000 units per reel)

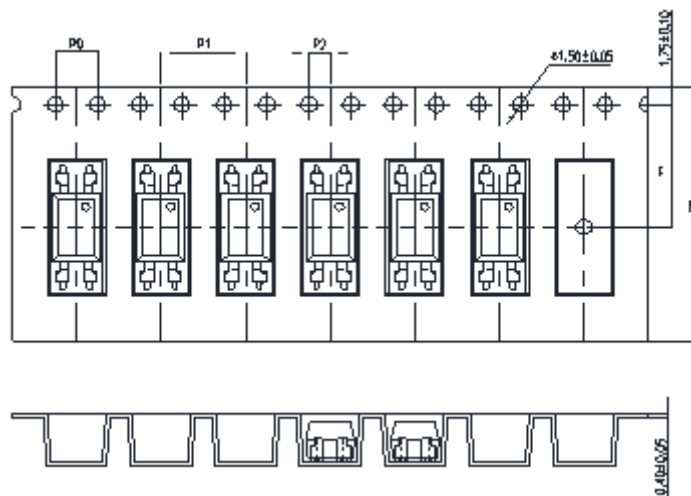

Fig. 21 - Tape and Reel Packaging for Option 8 (2000 units per reel)

SOLDER PROFILES

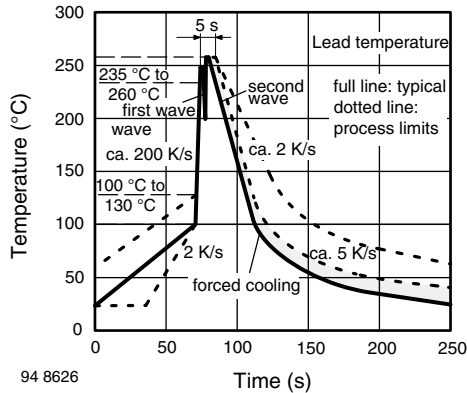

Fig. 22 - Wave Soldering Double Wave Profile According to J-STD-020 for DIP-8 Devices

HANDLING AND STORAGE CONDITIONS

ESD level: HBM class 2

Floor life: unlimited

Conditions: $T_{amb} < 30\text{ °C}$, RH < 85 %

Moisture sensitivity level 1, according to J-STD-020

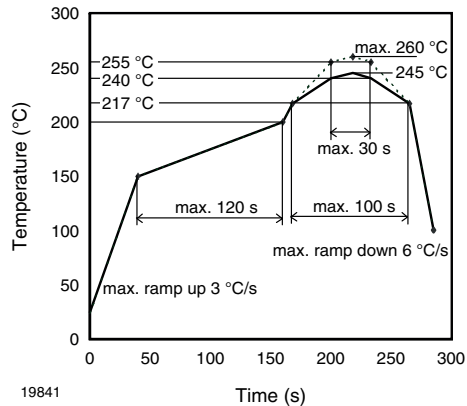

Fig. 23 - Lead (Pb)-free Reflow Solder Profile According to J-STD-020 for SMD-8 Devices



Disclaimer

ALL PRODUCT, PRODUCT SPECIFICATIONS AND DATA ARE SUBJECT TO CHANGE WITHOUT NOTICE TO IMPROVE RELIABILITY, FUNCTION OR DESIGN OR OTHERWISE.

Vishay Intertechnology, Inc., its affiliates, agents, and employees, and all persons acting on its or their behalf (collectively, "Vishay"), disclaim any and all liability for any errors, inaccuracies or incompleteness contained in any datasheet or in any other disclosure relating to any product.

Vishay makes no warranty, representation or guarantee regarding the suitability of the products for any particular purpose or the continuing production of any product. To the maximum extent permitted by applicable law, Vishay disclaims (i) any and all liability arising out of the application or use of any product, (ii) any and all liability, including without limitation special, consequential or incidental damages, and (iii) any and all implied warranties, including warranties of fitness for particular purpose, non-infringement and merchantability.

Statements regarding the suitability of products for certain types of applications are based on Vishay's knowledge of typical requirements that are often placed on Vishay products in generic applications. Such statements are not binding statements about the suitability of products for a particular application. It is the customer's responsibility to validate that a particular product with the properties described in the product specification is suitable for use in a particular application. Parameters provided in datasheets and / or specifications may vary in different applications and performance may vary over time. All operating parameters, including typical parameters, must be validated for each customer application by the customer's technical experts. Product specifications do not expand or otherwise modify Vishay's terms and conditions of purchase, including but not limited to the warranty expressed therein.

Except as expressly indicated in writing, Vishay products are not designed for use in medical, life-saving, or life-sustaining applications or for any other application in which the failure of the Vishay product could result in personal injury or death. Customers using or selling Vishay products not expressly indicated for use in such applications do so at their own risk. Please contact authorized Vishay personnel to obtain written terms and conditions regarding products designed for such applications.

No license, express or implied, by estoppel or otherwise, to any intellectual property rights is granted by this document or by any conduct of Vishay. Product names and markings noted herein may be trademarks of their respective owners.