



Chipsmall Limited consists of a professional team with an average of over 10 year of expertise in the distribution of electronic components. Based in Hongkong, we have already established firm and mutual-benefit business relationships with customers from,Europe,America and south Asia,supplying obsolete and hard-to-find components to meet their specific needs.

With the principle of “Quality Parts,Customers Priority,Honest Operation,and Considerate Service”,our business mainly focus on the distribution of electronic components. Line cards we deal with include Microchip,ALPS,ROHM,Xilinx,Pulse,ON,Everlight and Freescale. Main products comprise IC,Modules,Potentiometer,IC Socket,Relay,Connector.Our parts cover such applications as commercial,industrial, and automotives areas.

We are looking forward to setting up business relationship with you and hope to provide you with the best service and solution. Let us make a better world for our industry!



Contact us

Tel: +86-755-8981 8866 Fax: +86-755-8427 6832

Email & Skype: info@chipsmall.com Web: www.chipsmall.com

Address: A1208, Overseas Decoration Building, #122 Zhenhua RD., Futian, Shenzhen, China



Precision Voltage Reference

FEATURES

- ◆ +5 V Output, ± 0.5 mV (.01%)
- ◆ Temperature Drift: 0.6 ppm/°C
- ◆ Low Noise: 3 μ V_{P-P} (0.1Hz-10Hz)
- ◆ Low Thermal Hysteresis: 1 ppm Typical
- ◆ ± 15 mA Output Source and Sink Current
- ◆ Excellent Line Regulation: 5 ppm/V Typical
- ◆ Optional Noise Reduction and Voltage Trim
- ◆ Industry Standard Pinout: 8-pin Surface Mount Package

APPLICATIONS

The VRE3050 is recommended for use as a reference for 14, 16, or 18 bit data converters which require an external precision reference. The device is also ideal for calibrating scale factor on high resolution data converters. The VRE3050 offers superior performance over monolithic references.

DESCRIPTION

The VRE3050 is a low cost, high precision 5 V reference that operates from +10 V. The device features a buried zener for low noise and excellent long term stability. Packaged in an 8-pin SMT, the device is ideal for high resolution data conversion systems.

The device provides ultrastable +5 V output with ± 0.5 mV (.01%) initial accuracy and a temperature coefficient of 0.6 ppm/°C. This improvement in accuracy is made possible by a unique, patented multipoint laser compensation technique. Significant improvements have been made in other performance parameters as well, including initial accuracy, warm-up drift, line regulation, and long-term stability, making the VRE3050 series the most accurate reference available.

For enhanced performance, the VRE3050 has an external trim option for users who want less than 0.01% initial error. For ultra low noise applications, an external capacitor can be attached between the noise reduction pin and the ground pin.

Figure 1. BLOCK DIAGRAM

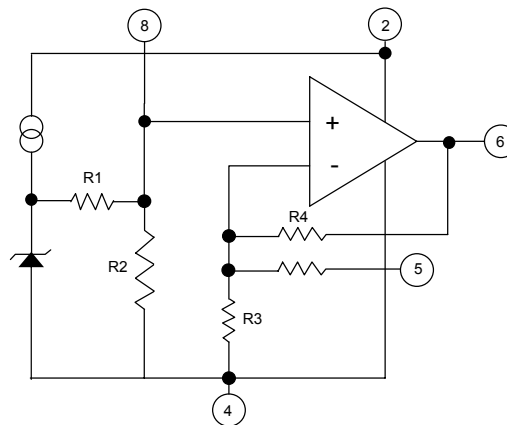

SELECTION GUIDE

Model	Initial Error (mV)	Temp. Coeff. (ppm/°C)	Temp. Range (°C)
VRE3050A	± 0.5	0.6	0°C to +70°C
VRE3050B	± 0.8	1.0	0°C to +70°C
VRE3050C	± 1.0	2.0	0°C to +70°C
VRE3050J	± 0.5	0.6	-40°C to +85°C
VRE3050K	± 0.8	1.0	-40°C to +85°C
VRE3050L	± 1.0	2.0	-40°C to +85°C

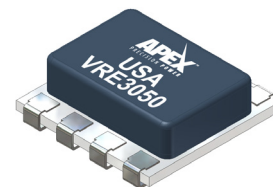

8-pin Surface Mount Package Style GF

1. CHARACTERISTICS AND SPECIFICATIONS

ABSOLUTE MAXIMUM RATINGS

Power Supply -0.3V to +40V
 OUT, TRIM..... -0.3V to +12V
 NR -0.3V to +6V
 Operating Temp. (A,B,C) 0°C to +70°C
 Operating Temp. (J,K,L) -40°C to +85°C

Out Short Circuit to GND Duration ($V_{IN} < 12V$) Continuous
 Out Short Circuit to GND Duration ($V_{IN} < 40V$) 5 sec
 Out Short Circuit to IN Duration ($V_{IN} < 12V$) Continuous
 Continuous Power Dissipation ($T_A = +70°C$) 300mW
 Storage Temperature -65°C to +150°C
 Lead Temperature (soldering, 10 sec) +250°C

ELECTRICAL SPECIFICATIONS

$V_{PS} = +15V$, $T = +25°C$, $R_L = 10K\Omega$ Unless Otherwise Noted.

Parameter	Symbol	Conditions	Min	Typ	Max	Units
Input Voltage	V_{IN}		+8		+36	V
Output Voltage (Note 1)	V_{OUT}	VRE3050A/J	+4.9995	+5.0000	+5.0005	V
		VRE3050B/K	+4.9992	+5.0000	+5.0008	
		VRE3050C/L	+4.9990	+5.0000	+5.0010	
Output Voltage Temperature Coefficient (Note 2)	TCV_{OUT}	VRE3050A/J		0.3	0.6	ppm/°C
		VRE3050B/K		0.5	1.0	
		VRE3050C/L		1.0	2.0	
Trim Adjustment Range	ΔV_{OUT}	Figure 3		±5.0		mV
Turn-On Settling Time	T_{ON}	To 0.01% of final value		2.0		µs
Output Noise Voltage	e_n	0.1Hz < f < 10Hz		3.0		µVp-p
		10Hz < f < 1kHz		2.5	5.0	µV _{RMS}
Temperature Hysterisis		Note 4		1		ppm
Long Term Stability	$\Delta V_{OUT/t}$			6		ppm/1000hrs.
Supply Current	I_{IN}			3.5	4.0	mA
Load Regulation (Note 3)	$\Delta V_{OUT} / \Delta I_{OUT}$	Sourcing: $0mA \leq I_{OUT} \leq 15mA$		8	12	ppm/mA
		Sinking: $-15mA \leq I_{OUT} \leq 0mA$		8	12	
Line Regulation (Note 3)	$\Delta V_{OUT} / \Delta V_{IN}$	$8V \leq V_{IN} \leq 10V$		25	35	ppm/V
		$10V \leq V_{IN} \leq 18V$		5	10	

NOTES:

1. The specified values are without external trim.
2. The temperature coefficient is determined by the box method. See discussion on temperature performance.
3. Line and load regulation are measured with pulses and do not include voltage changes due to temperature.
4. Hysterisis over the operating temperature range.

2. TYPICAL PERFORMANCE CURVES

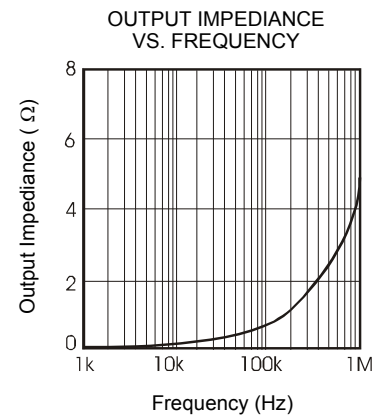
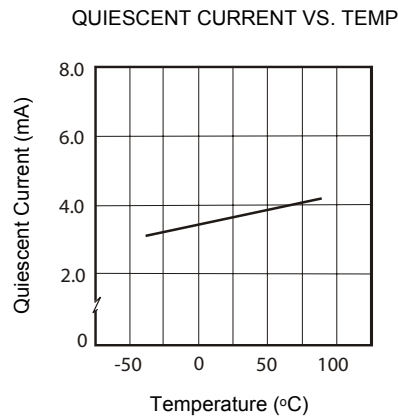
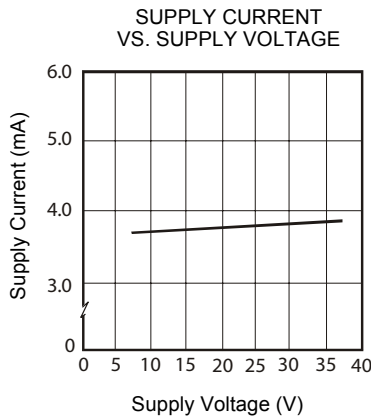
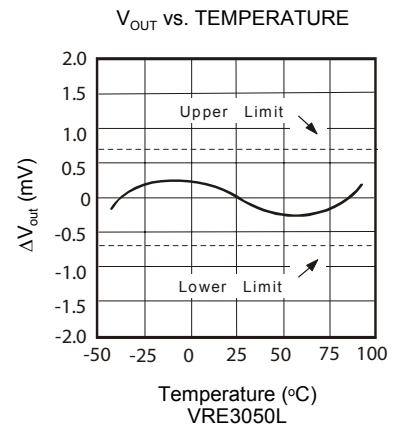
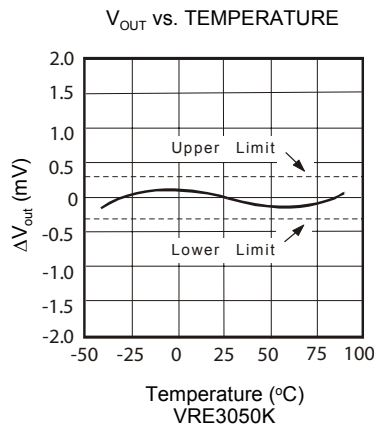
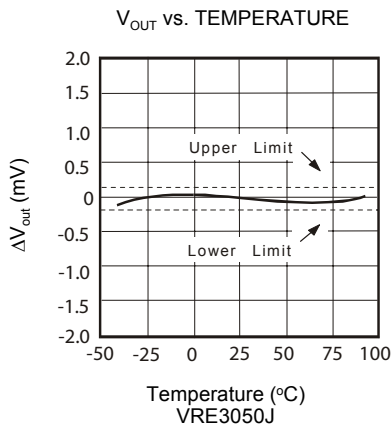
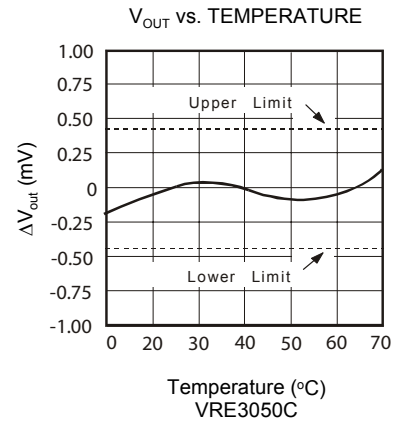
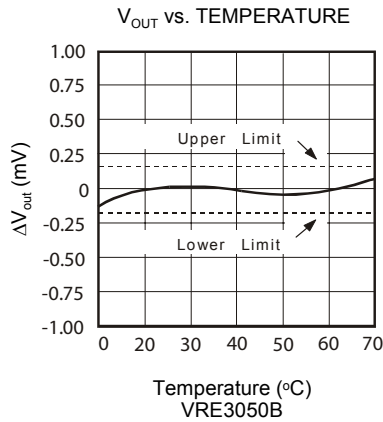
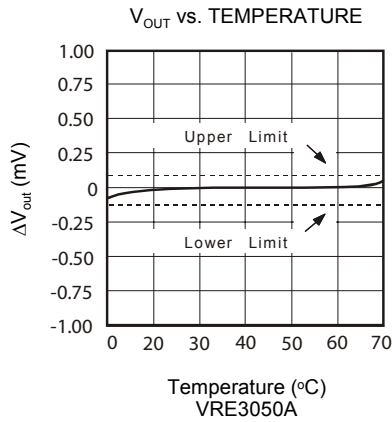

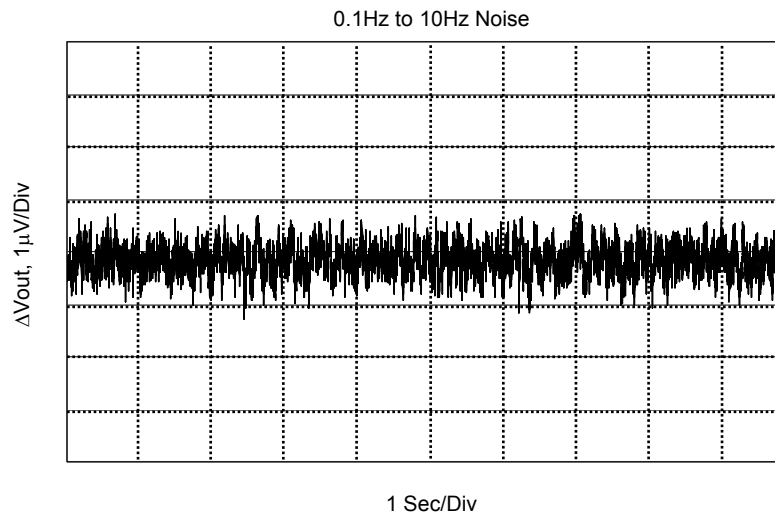
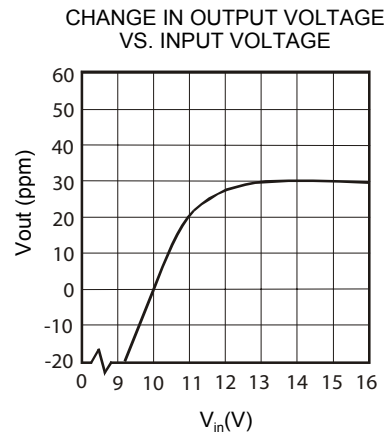
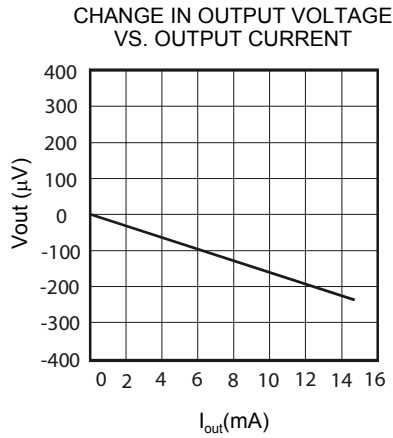
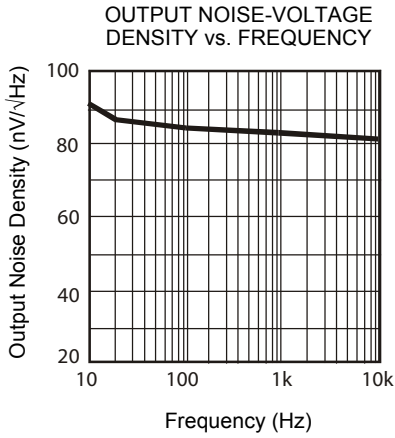
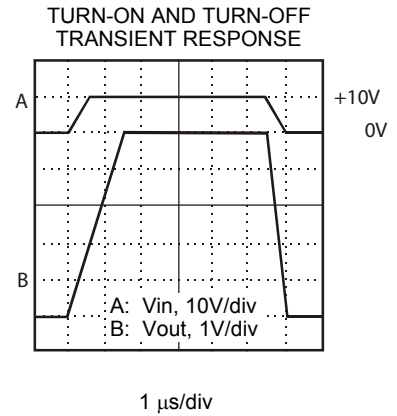
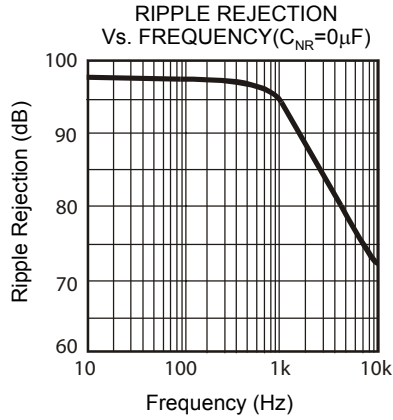
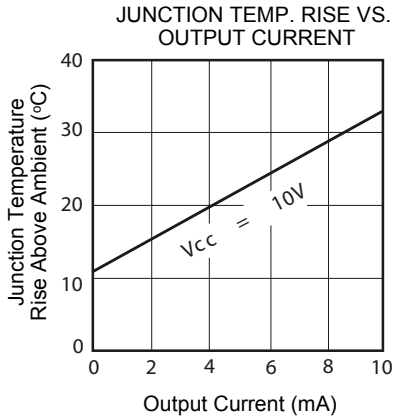

3. THEORY OF OPERATION

The following discussion refers to the block diagram in Figure 1. A FET current source is used to bias a 6.3 V zener diode. The zener voltage is divided by the resistor network R1 and R2. This voltage is then applied to the noninverting input of the operational amplifier which amplifies the voltage to produce a 5 V output. The gain is determined by the resistor networks R3 and R4: $G=1 + R4/R3$. The 6.3 V zener diode is used because it is the most stable diode over time and temperature.

The current source provides a closely regulated zener current, which determines the slope of the references' voltage vs. temperature function. By trimming the zener current a lower drift over temperature can be achieved. But since the voltage vs. temperature function is nonlinear this compensation technique is not well suited for wide temperature ranges.

A nonlinear compensation network of thermistors and resistors that is used in the VRE series voltage references. This proprietary network eliminates most of the nonlinearity in the voltage vs. temperature function. By adjusting the slope, a very stable voltage is produced over wide temperature ranges.

This network is less than 2% of the overall network resistance so it has a negligible effect on long term stability. The proper connection of the VRE3050 series voltage references with the optional trim resistor for initial error and the optional capacitor for noise reduction is shown below.

EXTERNAL CONNECTIONS

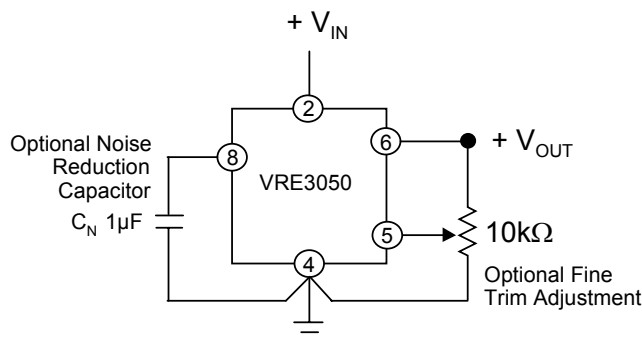

PIN DESCRIPTION

1, 3, 7	N. C.	Internally connected. Do not use
2	V _{IN}	Positive power supply input
4	GND	Ground
5	TRIM	External trim input. Leave open if not used.
6	OUT	Voltage reference output
8	NR	Noise Reduction

4. BASIC CIRCUIT CONNECTION

To achieve the specified performance, pay careful attention to the layout. A low resistance star configuration will reduce voltage errors, noise pickup, and noise coupled from the power supply. Commons should be connected to a single point to minimize interconnect resistances.

Figure 3.

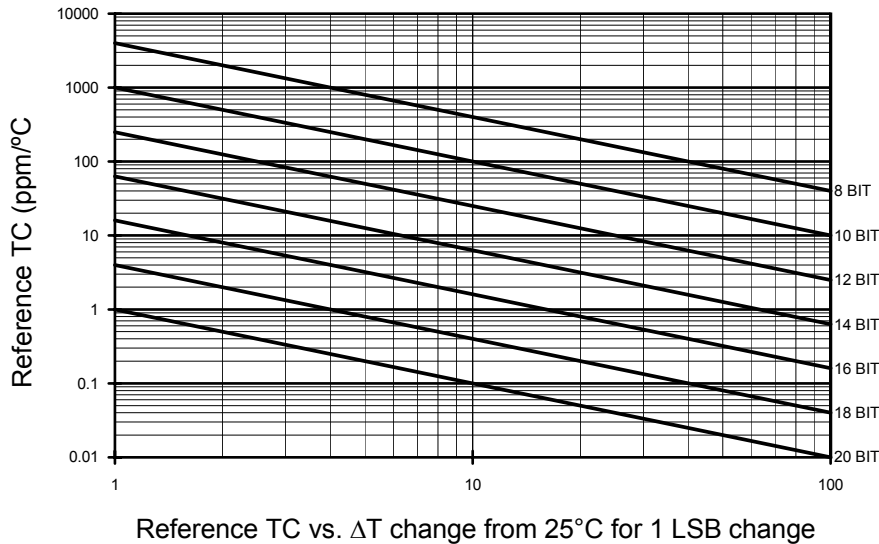

5. TEMPERATURE PERFORMANCE

The VRE3050 is designed for applications where the initial error at room temperature and drift over temperature are important to the user. For many instrument manufacturers, a voltage reference with a temperature coefficient less than 1 ppm/°C makes it possible to not perform a system temperature calibration, a slow and costly process.

Of the three TC specification methods (slope, butterfly, and box), the box method is most commonly used. A box is formed by the min/max limits for the nominal output voltage over the operating temperature range. The equation follows:

$$T.C. = \frac{V_{MAX} - V_{MIN}}{V_{NOMINAL} \times (T_{MAX} - T_{MIN})} \times 10^6$$

This method corresponds more accurately to the method of test and provides a closer estimate of actual error than the other methods. The box method guarantees limits for the temperature error but does not specify the exact shape and slope of the device under test.

A designer who needs a 14-bit accurate data acquisition system over the industrial temperature range (-40°C to +85°C), will need a voltage reference with a temperature coefficient (TC) of 1 ppm/°C if the reference is allowed to contribute an error equivalent to 1LSB. For 1/2LSB equivalent error from the reference you would need a voltage reference with a temperature coefficient of 0.5 ppm/°C. Figure 4 shows the required reference TC vs. delta T change from 25°C for resolution ranging from 8 bits to 20 bits.

6. THERMAL HYSTERISIS

A change in output voltage as a result of a temperature change. When references experience a temperature change and return to the initial temperature, they do not always have the same initial voltage. Thermal hysteresis is difficult to correct and is a major error source in systems that experience temperature changes greater than 25°C. Reference vendors are starting to include this important specification in their datasheets.

PIN CONFIGURATION

