



Chipsmall Limited consists of a professional team with an average of over 10 year of expertise in the distribution of electronic components. Based in Hongkong, we have already established firm and mutual-benefit business relationships with customers from,Europe,America and south Asia,supplying obsolete and hard-to-find components to meet their specific needs.

With the principle of “Quality Parts,Customers Priority,Honest Operation,and Considerate Service”,our business mainly focus on the distribution of electronic components. Line cards we deal with include Microchip,ALPS,ROHM,Xilinx,Pulse,ON,Everlight and Freescale. Main products comprise IC,Modules,Potentiometer,IC Socket,Relay,Connector.Our parts cover such applications as commercial,industrial, and automotives areas.

We are looking forward to setting up business relationship with you and hope to provide you with the best service and solution. Let us make a better world for our industry!



## Contact us

Tel: +86-755-8981 8866 Fax: +86-755-8427 6832

Email & Skype: info@chipsmall.com Web: www.chipsmall.com

Address: A1208, Overseas Decoration Building, #122 Zhenhua RD., Futian, Shenzhen, China



## Precision Dual Voltage Reference

### FEATURES

- ◆  $\pm 10$  V Output,  $\pm 1.6$  mV
- ◆ Temperature Drift: 1.0 ppm/°C
- ◆ Low Noise: 6  $\mu\text{V}_{\text{P-P}}$  (0.1-10Hz)
- ◆ Tracking Error: 0.3 mV
- ◆ Excellent Line Regulation: 6 ppm/V Typical
- ◆ Surface Mount Package

### APPLICATIONS

The VRE410 is recommended for use as a reference for high precision D/A and A/D converters which require an external precision reference. The device is also ideal for calibrating scale factor on high resolution A/D converters. The VRE410 offers superior performance over monolithic references.

### DESCRIPTION

The VRE410 is a low cost, high precision,  $\pm 10$  V reference. Available in a 14-pin SMT package, the device is ideal for new designs that need a high performance reference.

The device provides ultrastable  $\pm 10$  V output with  $\pm 1.6$  mV initial accuracy and a temperature coefficient of 1.0 ppm/°C. This improvement in accuracy is made possible by a unique, patented multipoint laser compensation technique.

Another key feature of this reference is the 0.5 mV tracking error between the positive and negative output voltages over the full operating temperature range. This is extremely important in high performance systems for reducing overall system errors.

Figure 1. BLOCK DIAGRAM

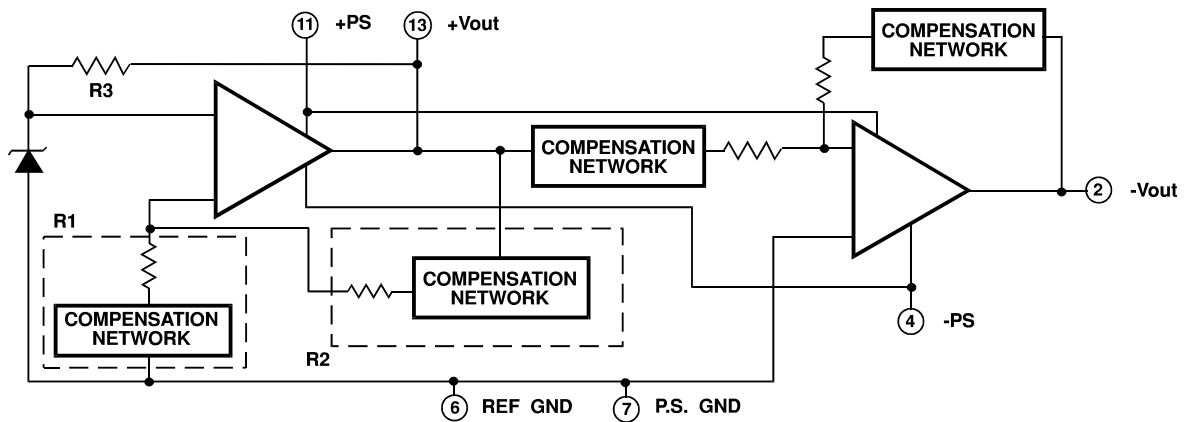

### SELECTION GUIDE

Model	Initial Error (mV)	Temp. Coeff. (ppm/°C)	Temp. Range (°C)
VRE410A	$\pm 1.6$	1.0	0°C to +70°C
VRE410B	$\pm 2.0$	2.0	0°C to +70°C
VRE410C	$\pm 2.2$	2.2	0°C to +70°C
VRE410J	$\pm 1.6$	1.0	-40°C to +85°C
VRE410L	$\pm 2.2$	2.2	-40°C to +85°C

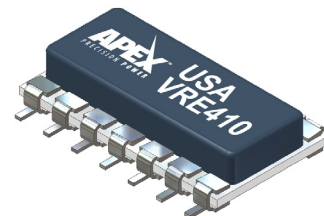

14-pin Surface Mount Package Style GE

# 1. CHARACTERISTICS AND SPECIFICATIONS

## ELECTRICAL SPECIFICATIONS

V<sub>PS</sub> = ±15V, T = +25°C, R<sub>L</sub> = 10KΩ Unless Otherwise Noted.

Model Parameter	A/J			B			C/L			Units
	Min	Typ	Max	Min	Typ	Max	Min	Typ	Max	
<b>ABSOLUTE RATINGS</b>										
Power Supply	±13.5	±15	±22	*	*	*	*	*	*	V
Operating Temperature (A,B,C)	0		+70	*		*	*		*	°C
Operating Temperature (J,L)	-40		+85	*		*	*		*	°C
Storage Temperature	-65		+150	*		*	*		*	°C
Short Circuit Protection	Continuous			*			*			
<b>OUTPUT VOLTAGE</b>										
VRE410		±10.0			*			*		V
<b>OUTPUT VOLTAGE ERRORS</b>										
Initial Error (Note 1)			±1.60			±2.00			±2.20	mV
Warmup Drift		1			2			3		ppm
T <sub>MIN</sub> - T <sub>MAX</sub> (Note 2)			1.0			2.0			2.2	ppm/°C
Tracking Error (Note 3)		0.5			0.7			1.0		mV
Long-Term Stability		6			*			*		ppm/1000hrs.
Noise (0.1 - 10Hz)		6			*			*		µVpp
<b>OUTPUT CURRENT</b>										
Range	±10			*						mA
<b>REGULATION</b>										
Line		3			*			*		ppm/V
Load		3			*			*		ppm/mA
<b>POWER SUPPLY CURRENT (Note 4)</b>										
+PS		7			*			*		mA
-PS		4			*			*		mA

**NOTES:**

- \* Same as A/J Models.
- 1. The specified values are without external trim.
- 2. The temperature coefficient (TC) is determined by the box method using the following formula:

$$T.C. = \frac{V_{MAX} - V_{MIN}}{V_{NOMINAL} \times (T_{MAX} - T_{MIN})} \times 10^6$$

- 3. The tracking error is the deviation between the positive and negative output over the operating temp. range.
- 4. The specified values are unloaded.

## 2. TYPICAL PERFORMANCE CURVES

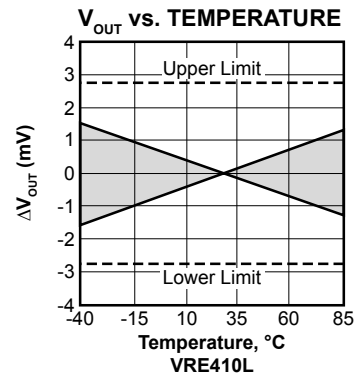
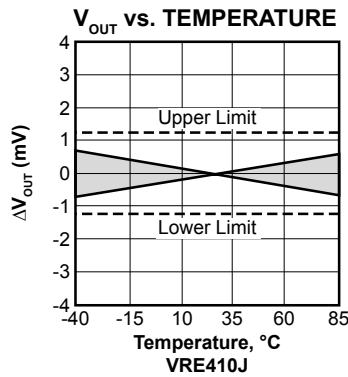
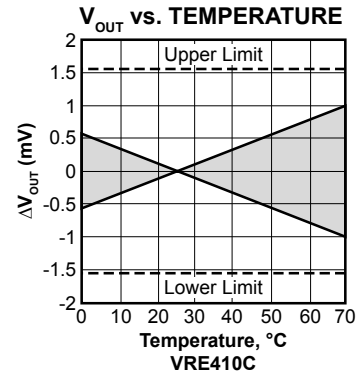
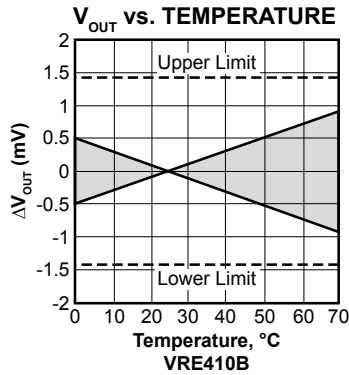
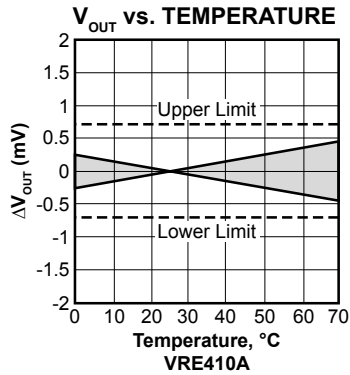

----- POSITIVE OUTPUT (TYP) -----

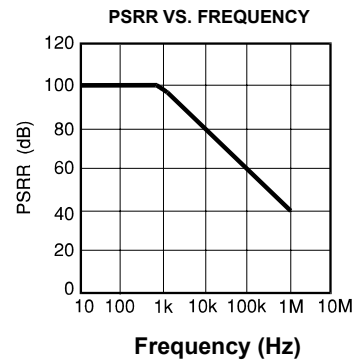
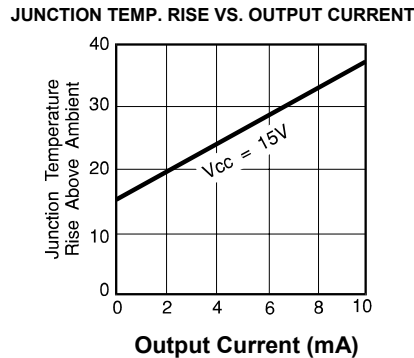
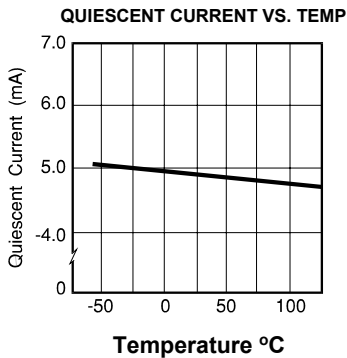

----- NEGATIVE OUTPUT (TYP) -----

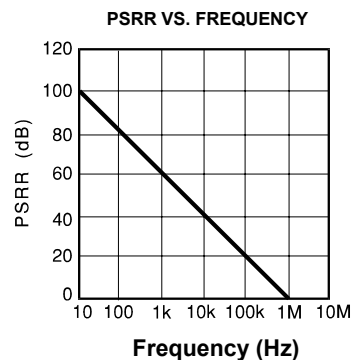
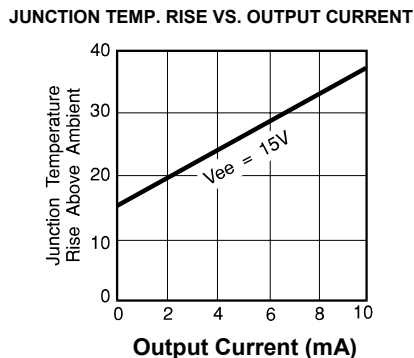
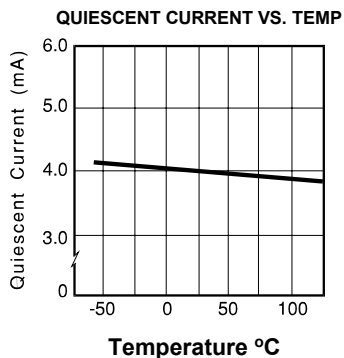

### 3. THEORY OF OPERATION

The following discussion refers to the block diagram in Figure 1. In operation, approximately 6.3 V is applied to the noninverting input of the op amp. The voltage is amplified by the op amp to produce a 10 V output. The gain is determined by the networks R1 and R2:  $G=1 + R2/R1$ . The 6.3 V zener diode is used because it is the most stable diode over time and temperature.

The zener operating current is derived from the regulated output voltage through R3. This feedback arrangement provides a closely regulated zener current. This current determines the slope of the references' voltage vs. temperature function. By trimming the zener current a lower drift over temperature can be achieved. But since the voltage vs. temperature function is nonlinear this compensation technique is not well suited for wide temperature ranges.

A nonlinear compensation network of thermistors and resistors is used in the VRE series voltage references. This proprietary network eliminates most of the nonlinearity in the voltage vs. temperature function. By then adjusting the slope, a very stable voltage is produced over wide temperature ranges.

The VRE400 series voltage references have the ground terminal brought out on two pins (pin 6 and 7) which are connected together internally. This allows the user to achieve greater accuracy when using a socket. Voltage references have a voltage drop across their power supply ground pin due to quiescent current flowing through the contact resistance. If the contact resistance was constant with time and temperature, this voltage drop could be trimmed out. When the reference is plugged into a socket, this source of error can be as high as 20 ppm. By connecting pin 7 to the power supply ground and pin 6 to a high impedance ground point in the measurement circuit, the error due to the contact resistance can be eliminated. If the unit is soldered into place the contact resistance is sufficiently small that it doesn't effect performance.

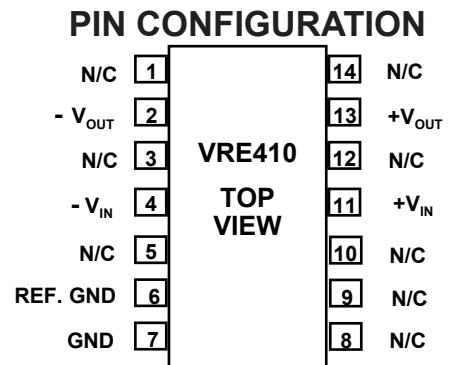

### 4. POWER SUPPLY SEQUENCING

Do not operate the VRE410 with only one power supply terminal connected. This device requires the positive power supply voltage to lead the negative power supply voltage. The positive power supply must be applied prior to the negative power supply.

## CONTACTING CIRRUS LOGIC SUPPORT

For all Apex Precision Power product questions and inquiries, call toll free 800-546-2739 in North America.

For inquiries via email, please contact [apex.support@cirrus.com](mailto:apex.support@cirrus.com).

International customers can also request support by contacting their local Cirrus Logic Sales Representative.

To find the one nearest to you, go to [www.cirrus.com](http://www.cirrus.com)

#### IMPORTANT NOTICE

Cirrus Logic, Inc. and its subsidiaries ("Cirrus") believe that the information contained in this document is accurate and reliable. However, the information is subject to change without notice and is provided "AS IS" without warranty of any kind (express or implied). Customers are advised to obtain the latest version of relevant information to verify, before placing orders, that information being relied on is current and complete. All products are sold subject to the terms and conditions of sale supplied at the time of order acknowledgment, including those pertaining to warranty, indemnification, and limitation of liability. No responsibility is assumed by Cirrus for the use of this information, including use of this information as the basis for manufacture or sale of any items, or for infringement of patents or other rights of third parties. This document is the property of Cirrus and by furnishing this information, Cirrus grants no license, express or implied under any patents, mask work rights, copyrights, trademarks, trade secrets or other intellectual property rights. Cirrus owns the copyrights associated with the information contained herein and gives consent for copies to be made of the information only for use within your organization with respect to Cirrus integrated circuits or other products of Cirrus. This consent does not extend to other copying such as copying for general distribution, advertising or promotional purposes, or for creating any work for resale.

CERTAIN APPLICATIONS USING SEMICONDUCTOR PRODUCTS MAY INVOLVE POTENTIAL RISKS OF DEATH, PERSONAL INJURY, OR SEVERE PROPERTY OR ENVIRONMENTAL DAMAGE ("CRITICAL APPLICATIONS"). CIRRUS PRODUCTS ARE NOT DESIGNED, AUTHORIZED OR WARRANTED TO BE SUITABLE FOR USE IN PRODUCTS SURGICALLY IMPLANTED INTO THE BODY, AUTOMOTIVE SAFETY OR SECURITY DEVICES, LIFE SUPPORT PRODUCTS OR OTHER CRITICAL APPLICATIONS. INCLUSION OF CIRRUS PRODUCTS IN SUCH APPLICATIONS IS UNDERSTOOD TO BE FULLY AT THE CUSTOMER'S RISK AND CIRRUS DISCLAIMS AND MAKES NO WARRANTY, EXPRESS, STATUTORY OR IMPLIED, INCLUDING THE IMPLIED WARRANTIES OF MERCHANTABILITY AND FITNESS FOR PARTICULAR PURPOSE, WITH REGARD TO ANY CIRRUS PRODUCT THAT IS USED IN SUCH A MANNER. IF THE CUSTOMER OR CUSTOMER'S CUSTOMER USES OR PERMITS THE USE OF CIRRUS PRODUCTS IN CRITICAL APPLICATIONS, CUSTOMER AGREES, BY SUCH USE, TO FULLY INDEMNIFY CIRRUS, ITS OFFICERS, DIRECTORS, EMPLOYEES, DISTRIBUTORS AND OTHER AGENTS FROM ANY AND ALL LIABILITY, INCLUDING ATTORNEYS' FEES AND COSTS, THAT MAY RESULT FROM OR ARISE IN CONNECTION WITH THESE USES.

Cirrus Logic, Cirrus, and the Cirrus Logic logo designs, Apex Precision Power, Apex and the Apex Precision Power logo designs are trademarks of Cirrus Logic, Inc. All other brand and product names in this document may be trademarks or service marks of their respective owners.