



Chipsmall Limited consists of a professional team with an average of over 10 year of expertise in the distribution of electronic components. Based in Hongkong, we have already established firm and mutual-benefit business relationships with customers from,Europe,America and south Asia,supplying obsolete and hard-to-find components to meet their specific needs.

With the principle of “Quality Parts,Customers Priority,Honest Operation,and Considerate Service”,our business mainly focus on the distribution of electronic components. Line cards we deal with include Microchip,ALPS,ROHM,Xilinx,Pulse,ON,Everlight and Freescale. Main products comprise IC,Modules,Potentiometer,IC Socket,Relay,Connector.Our parts cover such applications as commercial,industrial, and automotives areas.

We are looking forward to setting up business relationship with you and hope to provide you with the best service and solution. Let us make a better world for our industry!



## Contact us

Tel: +86-755-8981 8866 Fax: +86-755-8427 6832

Email & Skype: info@chipsmall.com Web: www.chipsmall.com

Address: A1208, Overseas Decoration Building, #122 Zhenhua RD., Futian, Shenzhen, China



### THREE PHASE BRIDGE

### Power Module

#### Features

- Low  $V_F$
- Low profile package
- Direct Mounting to heatsink
- Flat-Pin/ Round-Pin versions with PCB solderable terminals
- Low junction-to-case Thermal Resistance
- 3500  $V_{RMS}$  insulation voltage
- UL approval pending

#### Applications: Power conversion machines

- Welding
- UPS
- SMPS
- Motor Drives
- General Purpose & Heavy Duty Applications

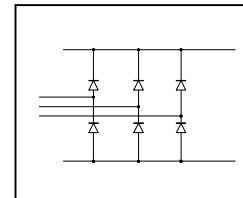
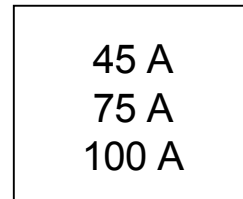

#### Description

A range of extremely compact three-phase rectifier bridges offering efficient and reliable operation. The low profile package has been specifically conceived to maximize space saving and optimize the electrical layout of the application specific Power Supplies.

#### Major Ratings and Characteristics

Parameters	40MT	70MT	100MT	Units
$I_O$	45	75	100	A
@ $T_C$	100	80	80	°C
$I_{FSM}$	270	380	450	A
@ 50Hz	280	398	470	
@ 60Hz	365	724	1013	$A^2s$
@ 50Hz	325	660	920	
@ 60Hz	3650	7240	10130	$A^2\sqrt{s}$
$V_{RRM}$	1400 & 1600			V
$T_{STG}$ range	-40 to 125			°C
$T_J$ range	-40 to 150			

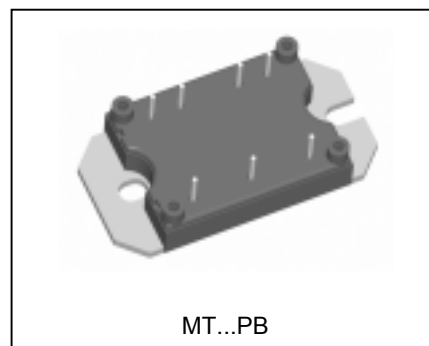
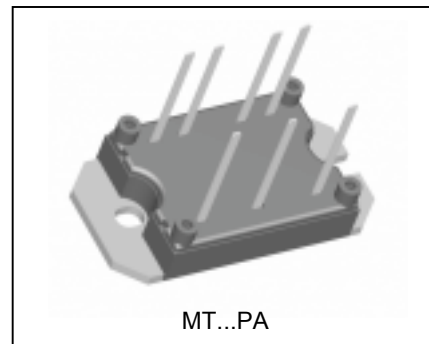

**ELECTRICAL SPECIFICATIONS**

Voltage Ratings

Type number	Voltage Code reverse voltage V	$V_{RRM}$ , maximum repetitive peak reverse voltage V	$V_{RSM}$ , maximum non-repetitive peak V	$I_{RRM}$ max. @ $T_J = 150^\circ\text{C}$ mA
40-70-100MT140P	140	1400	1500	5
40-70-100MT160P	160	1600	1700	

Forward Conduction

Parameter	40MT	70MT	100MT	Units	Conditions
$I_O$ Maximum DC output current @ Case temperature	45	75	100	A	120° Rect conduction angle
	100	80	80	°C	
$I_{FSM}$ Maximum peak, one-cycle forward, non-repetitive on state surge current	270	380	450	A	t = 10ms No voltage reappplied
	280	398	470		t = 8.3ms
	225	320	380		t = 10ms 100% $V_{RRM}$ reappplied
	240	335	400		t = 8.3ms
$I^2t$ Maximum $I^2t$ for fusing	365	724	1013	A <sup>2</sup> s	t = 10ms No voltage reappplied
	325	660	920		t = 8.3ms
	253	512	600		t = 10ms 100% $V_{RRM}$ reappplied
	240	467	665		t = 8.3ms
$I^2\sqrt{t}$ Maximum $I^2\sqrt{t}$ for fusing	3650	7240	10130	A <sup>2</sup> √s	t = 0.1 to 10ms, no voltage reappplied
$V_{F(TO)}$ Value of threshold voltage	0.78	0.82	0.75	V	@ $T_J$ max.
$r_t$ Slope resistance	14.8	9.5	8.1	mΩ	
$V_{FM}$ Maximum forward voltage drop	1.45 $I_{pk} = 40A$	1.45 $I_{pk} = 70A$	1.51 $I_{pk} = 100A$	V	$T_J = 25^\circ\text{C}$ $t_p = 400\mu\text{s}$ single junction

Insulation Table

Parameter	40MT	70MT	100MT	Units	Conditions
$V_{INS}$ RMS insulation voltage	3500			V	$T_J = 25^\circ\text{C}$ all terminal shorted f = 50Hz, t = 1s

**Thermal and Mechanical Specifications**

Parameter	40MT	70MT	100MT	Units	Conditions
T <sub>J</sub> Maximum junction operating temperature range	- 40 to 150			°C	
T <sub>stg</sub> Maximum storage temperature range	-40 to 125			°C	
R <sub>thJC</sub> Maximum thermal resistance, junction to case	0.27	0.23	0.19	K/W	DC operation per module
	1.6	1.38	1.14		DC operation per junction
	0.38	0.29	0.22		120° Rect conduction angle per module
	2.25	1.76	1.29		120° Rect conduction angle per junction
R <sub>thCS</sub> Maximum thermal resistance, case to heatsink	0.1			K/W	Per module. Mounting surface smooth, flat and greased. Heatsink compound thermal conductivity = 0.42W/mK
T Mounting torque ± 10% to heatsink	4			Nm	A mounting compound is recommended and the torque should be rechecked after a period of 3 hours to allow for the spread of the compound.
wt Approximate weight	65			g	Lubricated threads.

**Clearance and Creepage Distances**

Parameter	MT...PA	MT...PB	Units
Clearance (external shortest distance in air between terminals which are not internally short circuited together)	10.9	12.3	mm
Creepage distance (shortest distance along external surface of the insulating material between terminals which are not internally short circuited together)	10.9	12.3	mm

**Ordering Information Table**

**Device Code**

10	0	MT	160	P	B
①	②	③	④	⑤	

**1** - Current rating code

**2** - Circuit configuration code: 0 = 3-Phase Rectifier Bridge

**3** - Essential part number

**4** - Voltage code: code x 10 = V<sub>RRM</sub> (See Voltage Ratings table)

**5** - Pinout code:

4	= 45A
7	= 75A
10	= 100A

A	= Flat pins
B	= Round pins

# MTP 3-Phase Rectifier Series

Bulletin I27145 rev. B 06/02

International  
**IR** Rectifier

## Outline Table

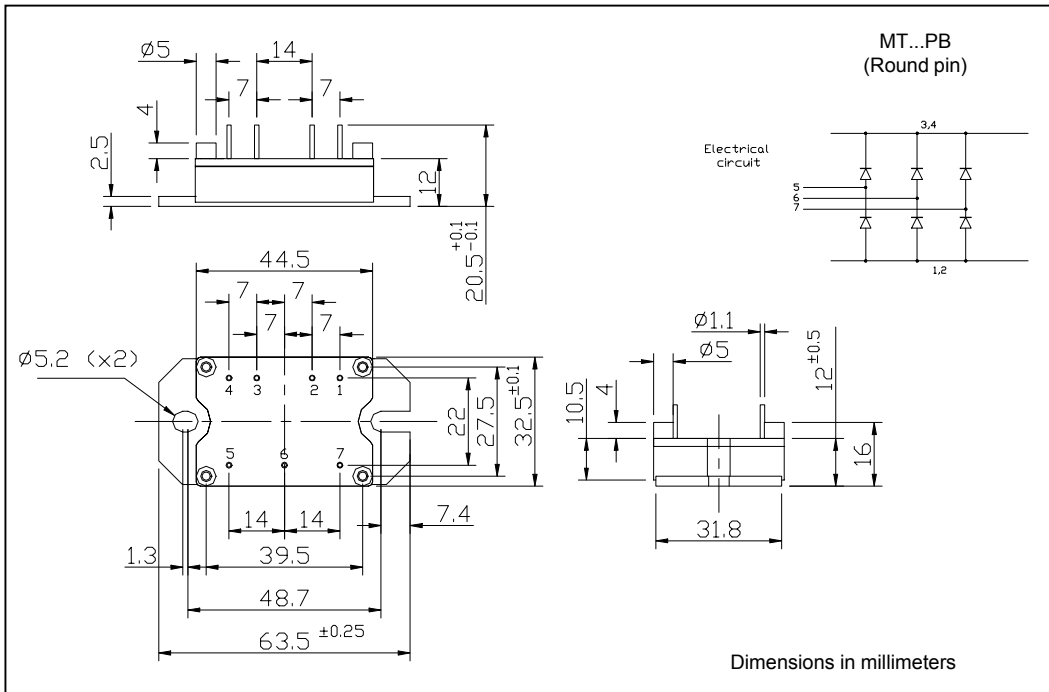
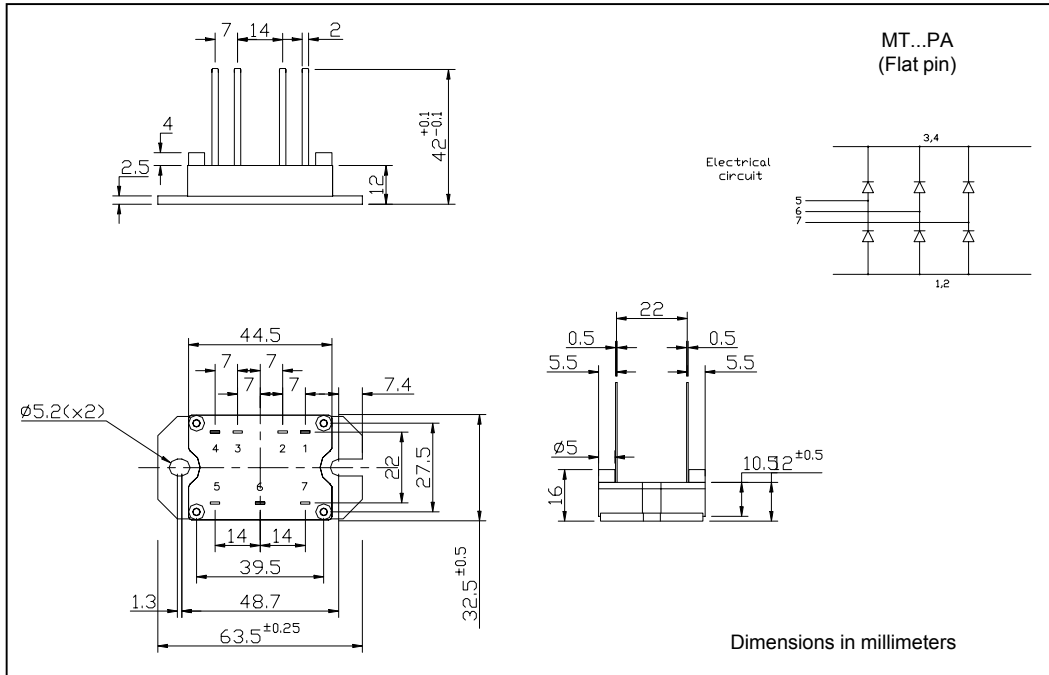

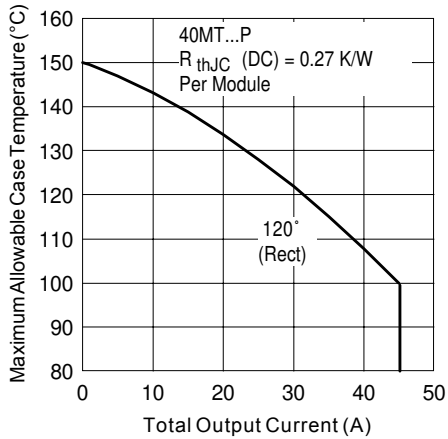

Fig. 1 - Current Rating Characteristics

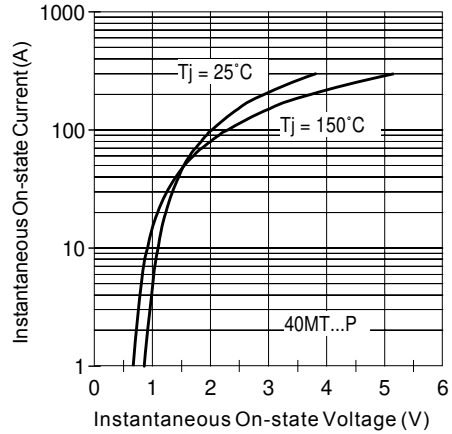

Fig. 2 - On-state Voltage Drop Characteristics

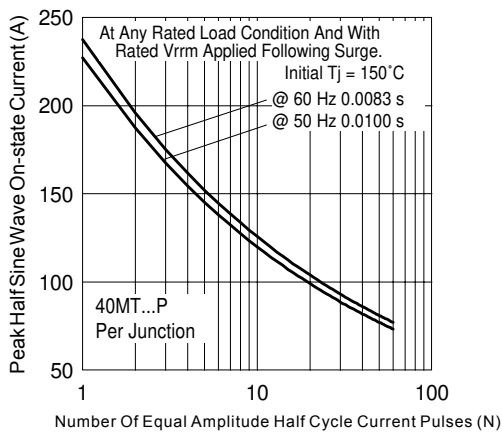

Fig. 3 - Maximum Non-Repetitive Surge Current

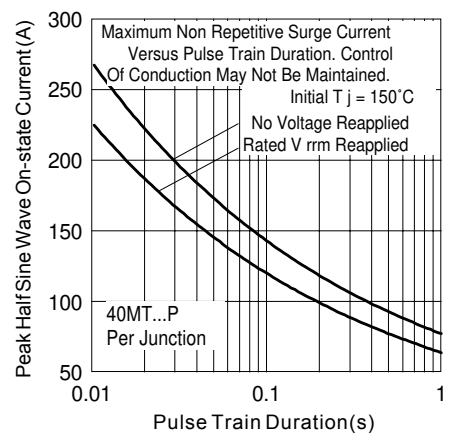

Fig. 4 - Maximum Non-Repetitive Surge Current

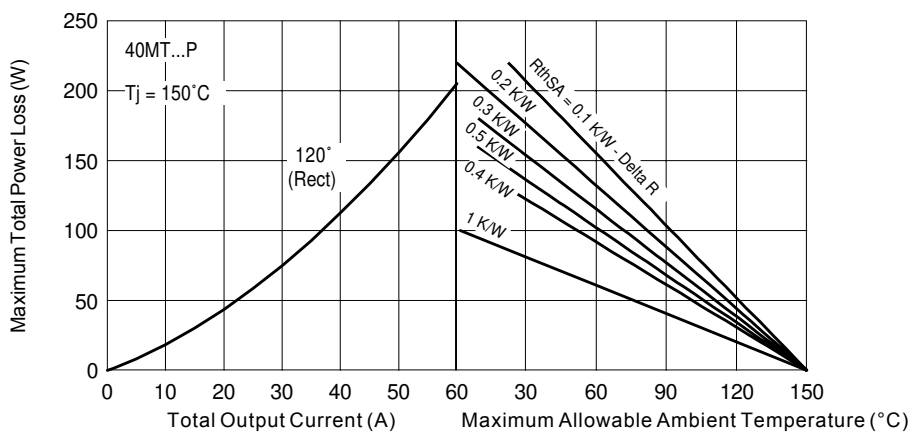

Fig. 5 - Current Rating Nomogram (1 Module Per Heatsink)

# MTP 3-Phase Rectifier Series

Bulletin I27145 rev. B 06/02

International  
**IRF** Rectifier

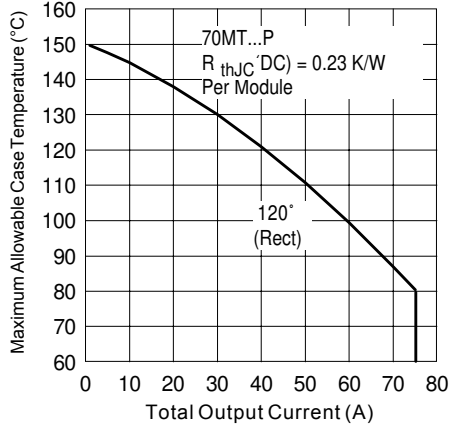

Fig. 6 - Current Rating Characteristics

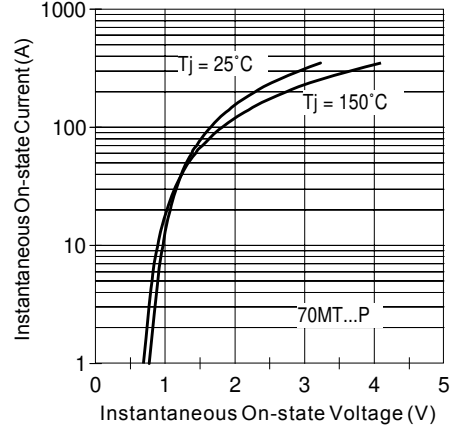

Fig. 7 - On-state Voltage Drop Characteristics

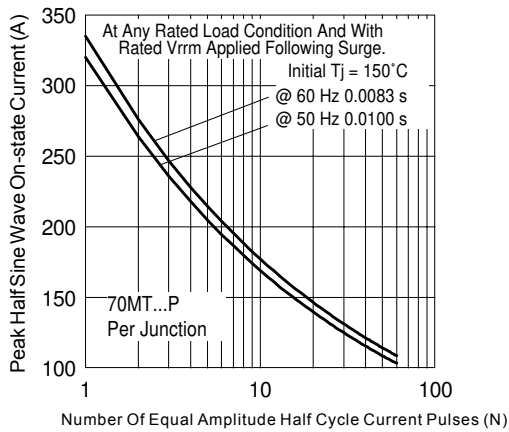

Fig. 8 - Maximum Non-Repetitive Surge Current

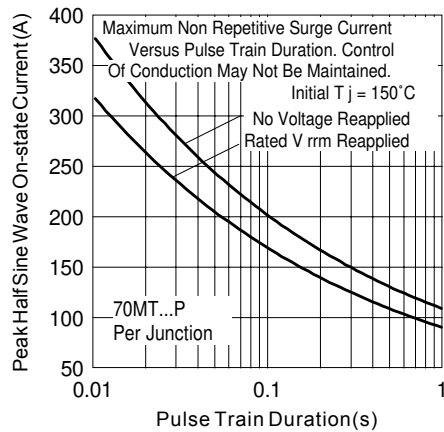

Fig. 9 - Maximum Non-Repetitive Surge Current

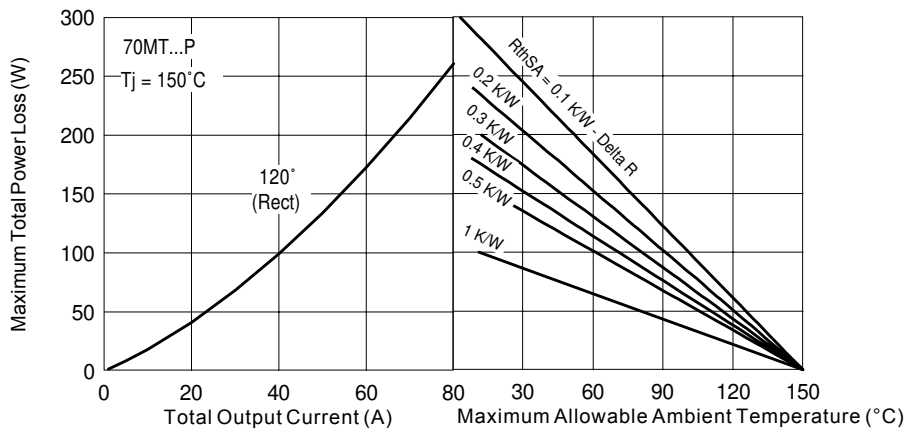

Fig. 10 - Current Rating Nomogram (1 Module Per Heatsink)



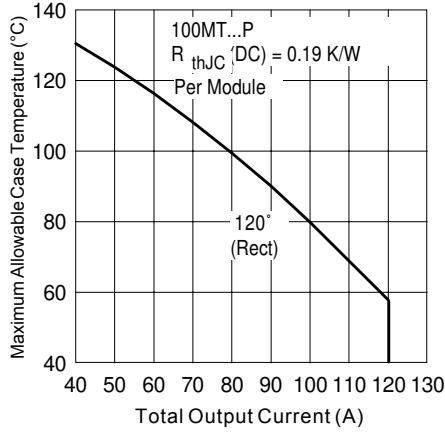

Fig. 11 - Current Rating Characteristics

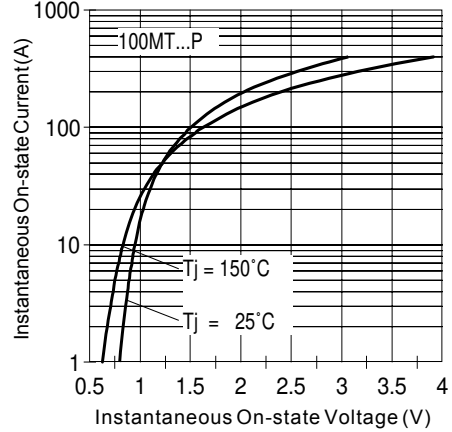

Fig. 12 - On-state Voltage Drop Characteristics

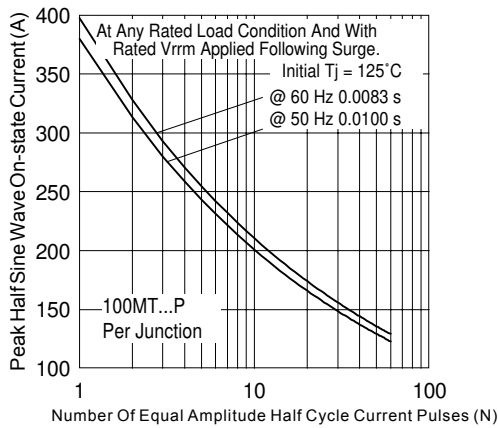

Fig. 13 - Maximum Non-Repetitive Surge Current

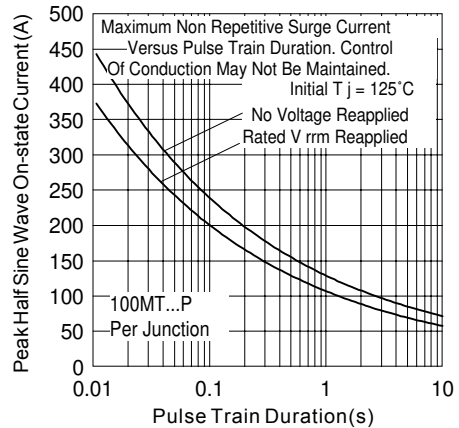

Fig. 14 - Maximum Non-Repetitive Surge Current

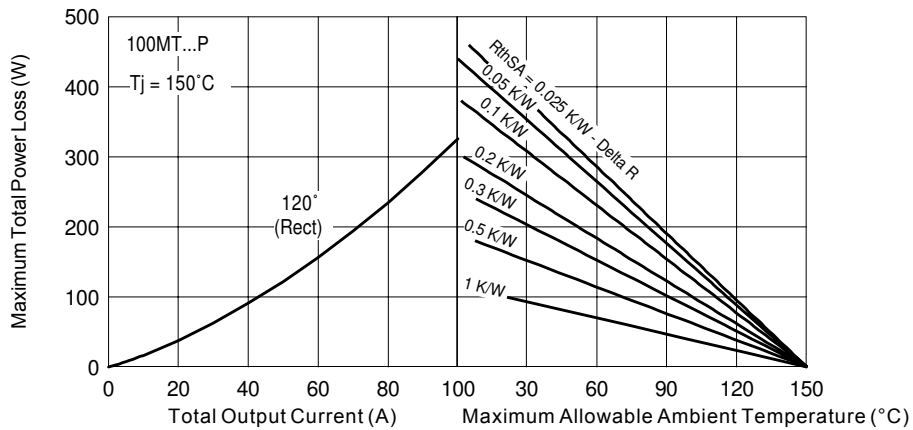

Fig. 15 - Current Rating Nomogram (1 Module Per Heatsink)



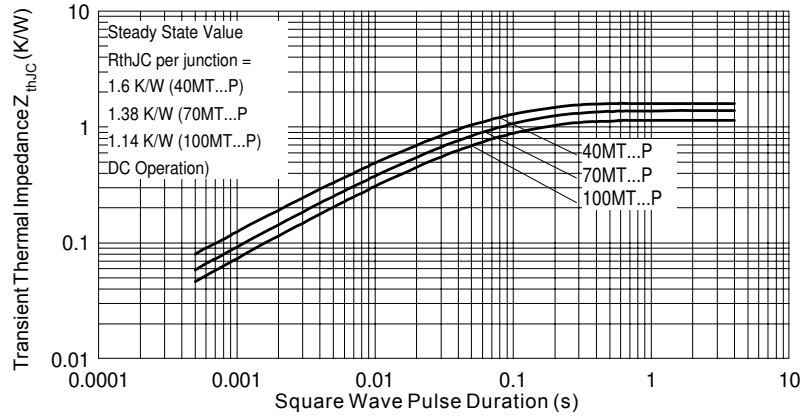

Fig. 16 - Thermal Impedance  $Z_{thJC}$  Characteristics

Data and specifications subject to change without notice.  
This product has been designed and qualified for Industrial Level.  
Qualification Standards can be found on IR's Web site.