



Chipsmall Limited consists of a professional team with an average of over 10 year of expertise in the distribution of electronic components. Based in Hongkong, we have already established firm and mutual-benefit business relationships with customers from,Europe,America and south Asia,supplying obsolete and hard-to-find components to meet their specific needs.

With the principle of "Quality Parts,Customers Priority,Honest Operation,and Considerate Service",our business mainly focus on the distribution of electronic components. Line cards we deal with include Microchip,ALPS,ROHM,Xilinx,Pulse,ON,Everlight and Freescale. Main products comprise IC,Modules,Potentiometer,IC Socket,Relay,Connector.Our parts cover such applications as commercial,industrial, and automotives areas.

We are looking forward to setting up business relationship with you and hope to provide you with the best service and solution. Let us make a better world for our industry!



## Contact us

Tel: +86-755-8981 8866 Fax: +86-755-8427 6832

Email & Skype: info@chipsmall.com Web: www.chipsmall.com

Address: A1208, Overseas Decoration Building, #122 Zhenhua RD., Futian, Shenzhen, China

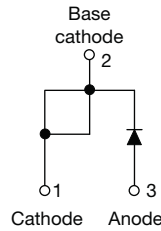

## Schottky Rectifier, 10 A

**TO-220AC**

### FEATURES

- 175 °C  $T_J$  operation
- Low forward voltage drop
- High frequency operation
- High purity, high temperature epoxy encapsulation for enhanced mechanical strength and moisture resistance
- Guard ring for enhanced ruggedness and long term reliability
- Compliant to RoHS Directive 2002/95/EC
- Designed and qualified according to JEDEC-JESD47
- Halogen-free according to IEC 61249-2-21 definition (-N3 only)



PRODUCT SUMMARY	
Package	TO-220AC
$I_{F(AV)}$	10 A
$V_R$	35 V, 40 V, 45 V
$V_F$ at $I_F$	0.49 V
$I_{RM}$	15 mA at 125 °C
$T_J$ max.	175 °C
Diode variation	Single die
$E_{AS}$	13 mJ

### DESCRIPTION

The VS-10TQ... Schottky rectifier series has been optimized for low reverse leakage at high temperature. The proprietary barrier technology allows for reliable operation up to 175 °C junction temperature. Typical applications are in switching power supplies, converters, freewheeling diodes, and reverse battery protection.

MAJOR RATINGS AND CHARACTERISTICS			
SYMBOL	CHARACTERISTICS	VALUES	UNITS
$I_{F(AV)}$	Rectangular waveform	10	A
$V_{RRM}$		35/45	V
$I_{FSM}$	$t_p = 5 \mu s$ sine	1050	A
$V_F$	10 $A_{pk}$ , $T_J = 125$ °C	0.49	V
$T_J$	Range	- 55 to 175	°C

VOLTAGE RATINGS								
PARAMETER	SYMBOL	VS-10TQ035PbF	VS-10TQ035-N3	VS-10TQ040PbF	VS-10TQ040-N3	VS-10TQ045PbF	VS-10TQ045-N3	UNITS
Maximum DC reverse voltage	$V_R$	35	35	40	40	45	45	V
Maximum working peak reverse voltage	$V_{RWM}$							

ABSOLUTE MAXIMUM RATINGS				
PARAMETER	SYMBOL	TEST CONDITIONS	VALUES	UNITS
Maximum average forward current See fig. 5	$I_{F(AV)}$	50 % duty cycle at $T_C = 151$ °C, rectangular waveform	10	A
Maximum peak one cycle non-repetitive surge current See fig. 7	$I_{FSM}$	5 $\mu s$ sine or 3 $\mu s$ rect. pulse	1050	
		10 ms sine or 6 ms rect. pulse	280	
Non-repetitive avalanche energy	$E_{AS}$	$T_J = 25$ °C, $I_{AS} = 2$ A, $L = 6.5$ mH	13	mJ
Repetitive avalanche current	$I_{AR}$	Current decaying linearly to zero in 1 $\mu s$ Frequency limited by $T_J$ maximum $V_A = 1.5 \times V_R$ typical	2	A



ELECTRICAL SPECIFICATIONS					
PARAMETER	SYMBOL	TEST CONDITIONS		VALUES	UNITS
Maximum forward voltage drop See fig. 1	V <sub>FM</sub> <sup>(1)</sup>	10 A	T <sub>J</sub> = 25 °C	0.57	V
		20 A		0.67	
		10 A	T <sub>J</sub> = 125 °C	0.49	
		20 A		0.61	
Maximum reverse leakage current See fig. 2	I <sub>RM</sub> <sup>(1)</sup>	T <sub>J</sub> = 25 °C	V <sub>R</sub> = Rated V <sub>R</sub>	2	mA
		T <sub>J</sub> = 125 °C		15	
Maximum junction capacitance	C <sub>T</sub>	V <sub>R</sub> = 5 V <sub>DC</sub> (test signal range 100 kHz to 1 MHz) 25 °C		900	pF
Typical series inductance	L <sub>S</sub>	Measured lead to lead 5 mm from package body		8.0	nH
Maximum voltage rate of change	dV/dt	Rated V <sub>R</sub>		10 000	V/μs

Note

(1) Pulse width < 300 μs, duty cycle < 2 %

THERMAL - MECHANICAL SPECIFICATIONS					
PARAMETER	SYMBOL	TEST CONDITIONS		VALUES	UNITS
Maximum junction and storage temperature range	T <sub>J</sub> , T <sub>Stg</sub>			- 55 to 175	°C
Maximum thermal resistance, junction to case	R <sub>thJC</sub>	DC operation See fig. 4		2.0	°C/W
Typical thermal resistance, case to heatsink	R <sub>thCS</sub>	Mounting surface, smooth and greased		0.50	
Approximate weight				2	g
				0.07	oz.
Mounting torque	minimum			6 (5)	kgf · cm (lbf · in)
	maximum			12 (10)	
Marking device		Case style TO-220AC		10TQ035	
				10TQ045	

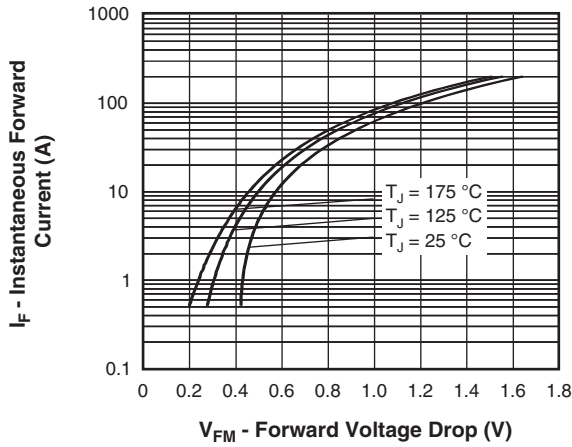

Fig. 1 - Maximum Forward Voltage Drop Characteristics

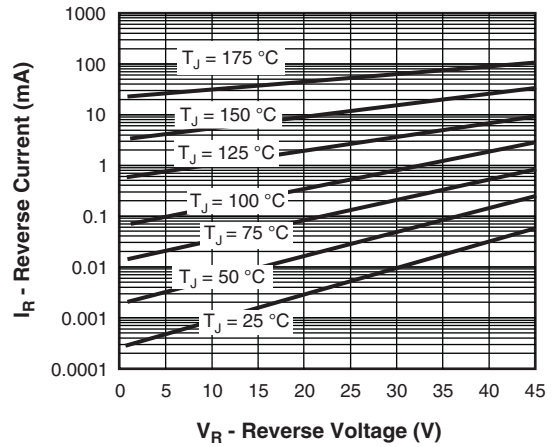

Fig. 2 - Typical Values of Reverse Current vs. Reverse Voltage

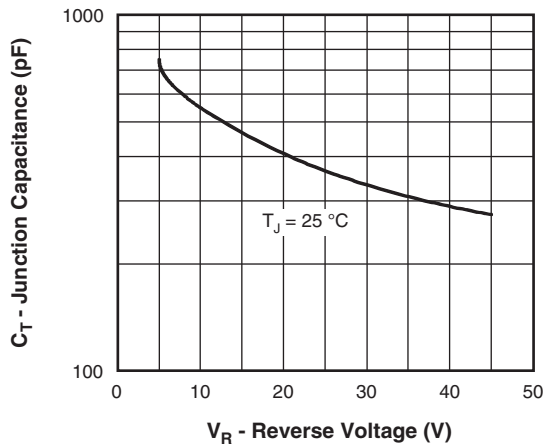

Fig. 3 - Typical Junction Capacitance vs. Reverse Voltage

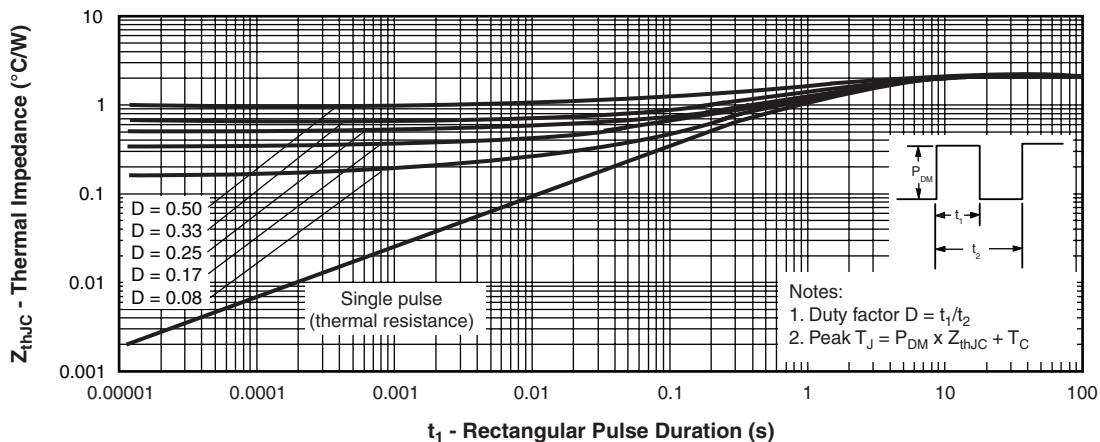

Fig. 4 - Maximum Thermal Impedance  $Z_{thJC}$  Characteristics

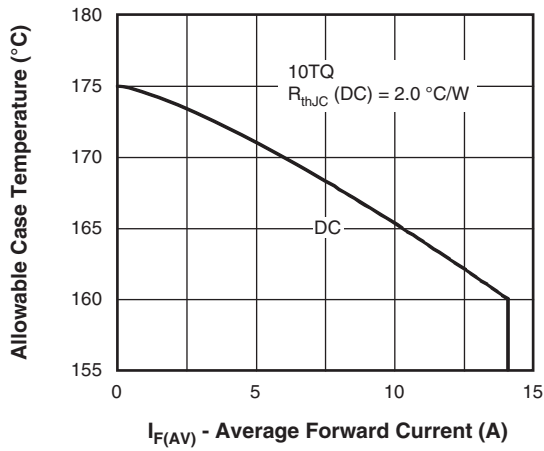

Fig. 5 - Maximum Allowable Case Temperature vs. Average Forward Current

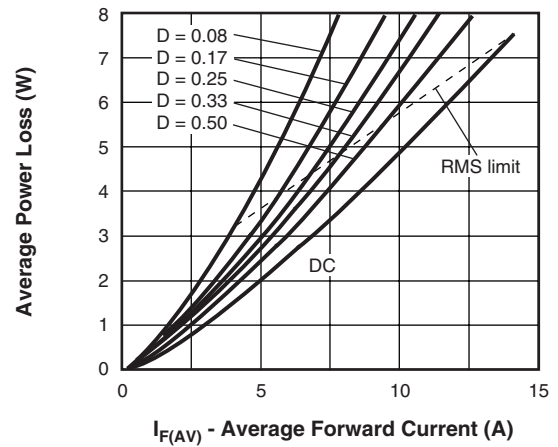

Fig. 6 - Forward Power Loss Characteristics

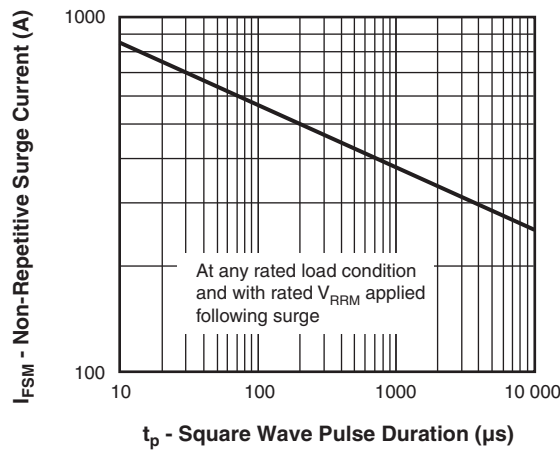

Fig. 7 - Maximum Non-Repetitive Surge Current

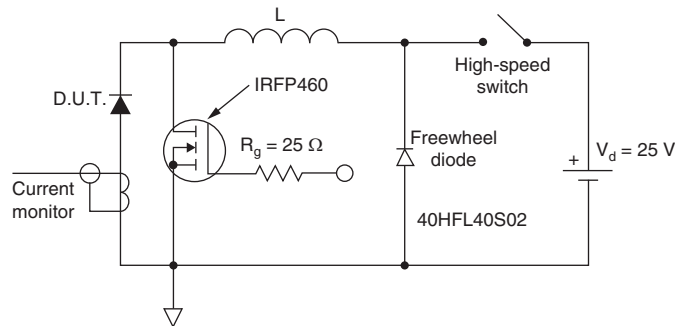
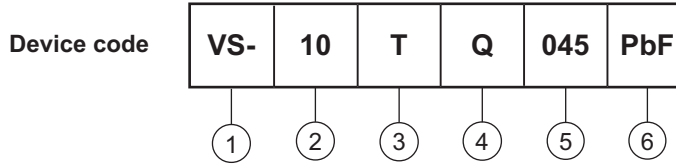

Fig. 8 - Unclamped Inductive Test Circuit



## ORDERING INFORMATION TABLE



- 1** - Vishay Semiconductors product
- 2** - Current rating (10 = 10 A)
- 3** - Package:  
T = TO-220
- 4** - Schottky "Q" series
- 5** - Voltage ratings
 

035 = 35 V
040 = 40 V
045 = 45 V
- 6** - Environmental digit
  - PbF = Lead (Pb)-free and RoHS compliant
  - -N3 = Halogen-free, RoHS compliant, and totally lead (Pb)-free

ORDERING INFORMATION (Example)			
PREFERRED P/N	QUANTITY PER T/R	MINIMUM ORDER QUANTITY	PACKAGING DESCRIPTION
VS-10TQ035PbF	50	1000	Antistatic plastic tube
VS-10TQ035-N3	50	1000	Antistatic plastic tube
VS-10TQ040PbF	50	1000	Antistatic plastic tube
VS-10TQ040-N3	50	1000	Antistatic plastic tube
VS-10TQ045PbF	50	1000	Antistatic plastic tube
VS-10TQ045-N3	50	1000	Antistatic plastic tube

LINKS TO RELATED DOCUMENTS	
Dimensions	<a href="http://www.vishay.com/doc?95221">www.vishay.com/doc?95221</a>
Part marking information	TO-220ACPbF <a href="http://www.vishay.com/doc?95224">www.vishay.com/doc?95224</a>
	TO-220AC-N3 <a href="http://www.vishay.com/doc?95068">www.vishay.com/doc?95068</a>

## TO-220AC

### DIMENSIONS in millimeters and inches

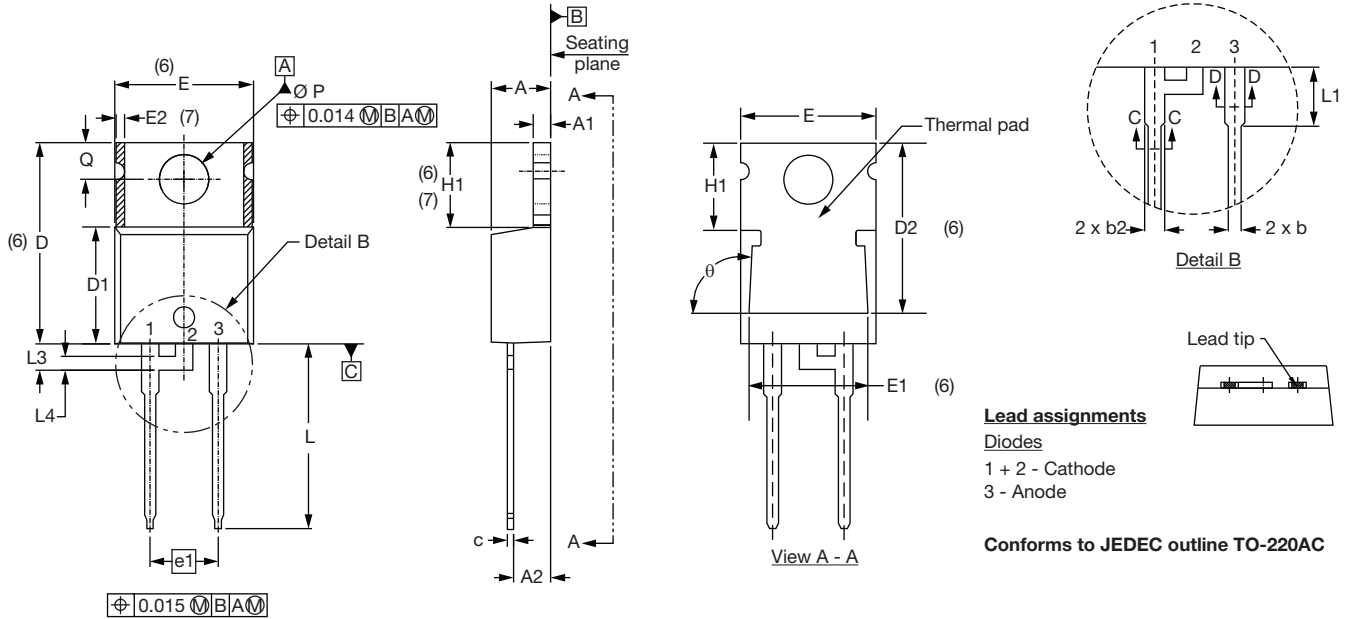

SYMBOL	MILLIMETERS		INCHES		NOTES	SYMBOL	MILLIMETERS		INCHES		NOTES
	MIN.	MAX.	MIN.	MAX.			MIN.	MAX.	MIN.	MAX.	
A	4.25	4.65	0.167	0.183		E1	6.86	8.89	0.270	0.350	6
A1	1.14	1.40	0.045	0.055		E2	-	0.76	-	0.030	7
A2	2.56	2.92	0.101	0.115		e	2.41	2.67	0.095	0.105	
b	0.69	1.01	0.027	0.040		e1	4.88	5.28	0.192	0.208	
b1	0.38	0.97	0.015	0.038	4	H1	6.09	6.48	0.240	0.255	6, 7
b2	1.20	1.73	0.047	0.068		L	13.52	14.02	0.532	0.552	
b3	1.14	1.73	0.045	0.068	4	L1	3.32	3.82	0.131	0.150	2
c	0.36	0.61	0.014	0.024		L3	1.78	2.13	0.070	0.084	
c1	0.36	0.56	0.014	0.022	4	L4	0.76	1.27	0.030	0.050	2
D	14.85	15.25	0.585	0.600	3	Ø P	3.54	3.73	0.139	0.147	
D1	8.38	9.02	0.330	0.355		Q	2.60	3.00	0.102	0.118	
D2	11.68	12.88	0.460	0.507	6	θ	90° to 93°		90° to 93°		
E	10.11	10.51	0.398	0.414	3, 6						

### Notes

- (1) Dimensioning and tolerancing as per ASME Y14.5M-1994
- (2) Lead dimension and finish uncontrolled in L1
- (3) Dimension D, D1 and E do not include mold flash. Mold flash shall not exceed 0.127 mm (0.005") per side. These dimensions are measured at the outermost extremes of the plastic body
- (4) Dimension b1, b3 and c1 apply to base metal only
- (5) Controlling dimension: inches
- (6) Thermal pad contour optional within dimensions E, H1, D2 and E1
- (7) Dimension E2 x H1 define a zone where stamping and singulation irregularities are allowed
- (8) Outline conforms to JEDEC TO-220, D2 (minimum) where dimensions are derived from the actual package outline



## Disclaimer

ALL PRODUCT, PRODUCT SPECIFICATIONS AND DATA ARE SUBJECT TO CHANGE WITHOUT NOTICE TO IMPROVE RELIABILITY, FUNCTION OR DESIGN OR OTHERWISE.

Vishay Intertechnology, Inc., its affiliates, agents, and employees, and all persons acting on its or their behalf (collectively, "Vishay"), disclaim any and all liability for any errors, inaccuracies or incompleteness contained in any datasheet or in any other disclosure relating to any product.

Vishay makes no warranty, representation or guarantee regarding the suitability of the products for any particular purpose or the continuing production of any product. To the maximum extent permitted by applicable law, Vishay disclaims (i) any and all liability arising out of the application or use of any product, (ii) any and all liability, including without limitation special, consequential or incidental damages, and (iii) any and all implied warranties, including warranties of fitness for particular purpose, non-infringement and merchantability.

Statements regarding the suitability of products for certain types of applications are based on Vishay's knowledge of typical requirements that are often placed on Vishay products in generic applications. Such statements are not binding statements about the suitability of products for a particular application. It is the customer's responsibility to validate that a particular product with the properties described in the product specification is suitable for use in a particular application. Parameters provided in datasheets and/or specifications may vary in different applications and performance may vary over time. All operating parameters, including typical parameters, must be validated for each customer application by the customer's technical experts. Product specifications do not expand or otherwise modify Vishay's terms and conditions of purchase, including but not limited to the warranty expressed therein.

Except as expressly indicated in writing, Vishay products are not designed for use in medical, life-saving, or life-sustaining applications or for any other application in which the failure of the Vishay product could result in personal injury or death. Customers using or selling Vishay products not expressly indicated for use in such applications do so at their own risk. Please contact authorized Vishay personnel to obtain written terms and conditions regarding products designed for such applications.

No license, express or implied, by estoppel or otherwise, to any intellectual property rights is granted by this document or by any conduct of Vishay. Product names and markings noted herein may be trademarks of their respective owners.

## Material Category Policy

**Vishay Intertechnology, Inc. hereby certifies that all its products that are identified as RoHS-Compliant fulfill the definitions and restrictions defined under Directive 2011/65/EU of The European Parliament and of the Council of June 8, 2011 on the restriction of the use of certain hazardous substances in electrical and electronic equipment (EEE) - recast, unless otherwise specified as non-compliant.**

**Please note that some Vishay documentation may still make reference to RoHS Directive 2002/95/EC. We confirm that all the products identified as being compliant to Directive 2002/95/EC conform to Directive 2011/65/EU.**

**Vishay Intertechnology, Inc. hereby certifies that all its products that are identified as Halogen-Free follow Halogen-Free requirements as per JEDEC JS709A standards. Please note that some Vishay documentation may still make reference to the IEC 61249-2-21 definition. We confirm that all the products identified as being compliant to IEC 61249-2-21 conform to JEDEC JS709A standards.**